

# TAMB2

## Telephone Paging Access Module

The TAMB2 telephone paging access module provides a means of interfacing various analog telephone port types to a paging system amplifier to enable a facility's telephone system to be used to make audio announcements over its paging system. The TAMB2 will interface to analog loop start and ground start trunk ports as well as analog ring-up station lines. It provides a means of connecting an external audio or music source that will play over the paging system when no pages

are in progress. A set of contacts are provided to signal external equipment of the TAMB2's operational status. Various DIP switches and controls provide a wide range of flexibility over how the access module will operate. The TAMB2 can be mounted on a wall, mounted as a single unit in a rack (optional rack mount kit required) or mounted 2-up, side-by-side in a single rack space.

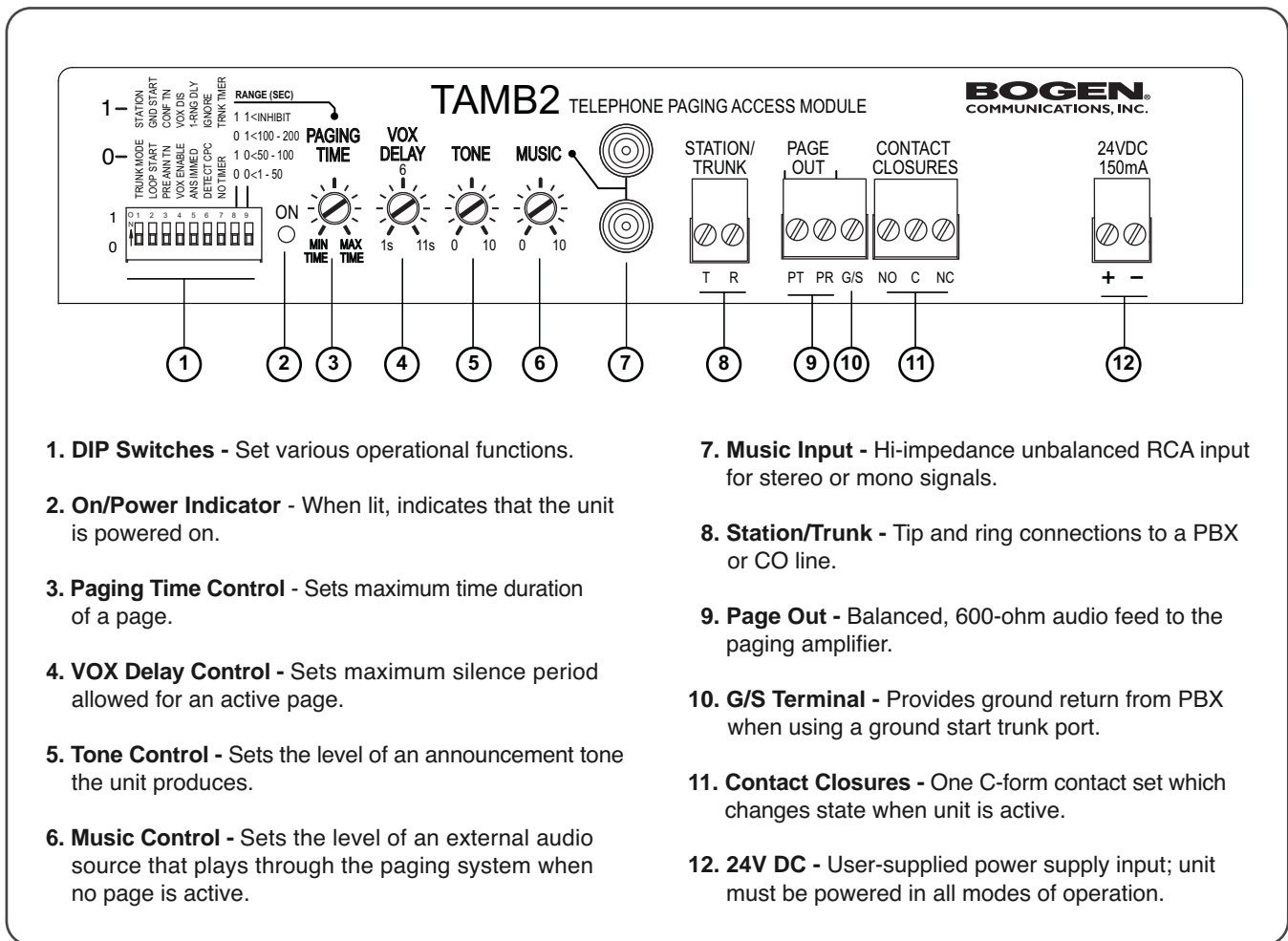

## Notice

Every effort was made to ensure that the information in this manual was complete and accurate at the time of printing. However, information is subject to change.

### FCC Statement (Part 15) - Radio Frequency Interference

This unit generates and uses radio frequency energy and if not installed and used in strict accordance with the manufacturer's instructions, may cause interference to radio and television reception. Testing is being conducted for compliance with the limits for a Class B device in accordance with the specifications in Part 15 of the FCC Rules and Canadian D.O.C. regulations. This testing is designed to provide reasonable protection against such interference. However, there is no guarantee that interference will not occur in a particular installation. If this equipment does cause interference to radio or television reception, which can be determined by turning the unit off and on, the user is encouraged to try to correct the interference by one or more of the following measures:

- Reorient the radio or TV receiving antenna.
- Relocate the unit with respect to the radio or TV receiver or vice versa.
- Plug the unit into a different outlet so that it and the radio or TV receiver are on different branch circuits.

If necessary, the user should consult the dealer or an experienced radio/television technician for additional suggestions. The user may find the following booklet, "How To Identify and Resolve Radio-TV Interference Problems," helpful. This booklet was prepared by the Federal Communications Commission (FCC) and is available from the U.S. Government Printing Office, Washington, DC 20402. Stock order No. 004-000-00345-4.

### Federal Communications Commission (FCC) Statement (Part 68)

This equipment is component registered with the Federal Communications Commission (FCC) in accordance with Part 68 of its rules. In compliance with the rules, be advised of the following:

Registered equipment may not be used with Coin Telephone Lines. Equipment may be used with Party Lines in areas where state tariffs permit such connections and when equipment is adaptable for such service.

This equipment is registered as follows:  
Registration Number - US: CD2PA13BTAMB2  
Ringer Equivalence - 1.3B

If trouble is experienced, the equipment should be disconnected from the interface to determine if this equipment, or the telephone line, is the trouble source. If the equipment is determined to be malfunctioning, it should not be reconnected until repairs are effected.

Repairs to this equipment, other than routine repairs, can be made only by the manufacturer or its authorized agents.

If the equipment causes harm to the telephone network, the local telephone company may temporarily discontinue your service and, if possible, notify you in advance. If advance notice is not practical, you will be notified as soon as possible. You will be given the opportunity to correct the problem and informed of your right to file a complaint with the FCC.

The local telephone company may make changes in its facilities, operations, or procedures that could affect the proper functioning of your equipment. If they do, you will be given adequate notice in writing to allow you an opportunity to maintain uninterrupted telephone service.

## Important Safety Information

Always follow these basic safety precautions when installing and using the system:

1. Read and understand all instructions.
2. Follow all warnings and instructions marked on the product.
3. DO NOT block or cover the ventilation slots and openings. They prevent the product from overheating. DO NOT place the product in a separate enclosure or cabinet, unless proper ventilation is provided.
4. Never spill liquid on the product or drop objects into the ventilation slots and openings. Doing so may result in serious damage to the components.
5. Repair or service must be performed by a factory authorized repair facility.
6. The product is provided with a UL-CSA approved, 3-wire ground type plug. This is a safety feature. DO NOT defeat the safety purpose of the grounding type plug. DO NOT staple or otherwise attach the AC power supply cord to building surfaces.
7. DO NOT use the product near water or in a wet or damp place (such as a wet basement).
8. DO NOT use extension cords. The product must be installed within 6 feet of a grounded outlet receptacle.
9. DO NOT install telephone wiring during a lightning storm.
10. DO NOT install telephone jacks in a wet location unless the jack is specifically designed for wet locations.
11. Never touch uninsulated wires or terminals, unless the line has been disconnected at the paging or controller interface.
12. Use caution when installing or modifying paging or control lines.

### CAUTION

**RISK OF ELECTRIC SHOCK  
DO NOT OPEN**

**CAUTION: TO PREVENT THE RISK OF ELECTRIC SHOCK, DO NOT REMOVE ANY FRONT/BACK COVERS OR PANELS. NO USER-SERVICEABLE PARTS INSIDE.**

**REFER SERVICING TO QUALIFIED PERSONNEL.**



The lightning flash with arrowhead symbol, within an equilateral triangle, is intended to alert the user to the presence of uninsulated "dangerous voltage" within the product's enclosure that may be of sufficient magnitude to constitute a risk of electric shock to persons.



The exclamation point within an equilateral triangle is intended to alert the user to the presence of important operating and maintenance (servicing) instructions.

# Theory of Operation

## Loop Start Interfacing:

The TAMB2 provides a 24V DC talk battery on its T (tip) and R (ring) terminals. When it detects a DC loop current flow through these terminals, it will activate. Upon activation, it will produce an announcement tone and connect in the paging amplifier through an isolation transformer. The announcement tone can be set to be heard only at the paging phone or at both the phone and over the paging system. The TAMB2 allows bi-directional audio, both to and from the paging equipment

(in the case of talkback paging equipment). Disconnection of the page happens when the loop start trunk goes on hook and loop current flow stops. In this mode, the TAMB2 responds to the status of the loop current flow and generally no timers are needed to control when it disconnects. However, a Trunk Timer feature is provided that can help prevent accidental lock-up of the paging system (see feature's description below).

## Ground Start Interfacing:

In addition to the tip and ring connections to this port, an additional connection between the TAMB2's G/S terminal and the PBX ground must be established. When idle, the TAMB2 opens an internal relay contact in series with its T (tip) terminal, and monitors for loop current flowing in its R (ring) terminal. When the PBX grounds the TAMB2's R terminal, loop current flows and is detected. The TAMB2 responds by closing the relay contact in series with its T terminal. Once this connection is established, the TAMB2 will produce an announcement tone and connect in the paging amplifier through an isolation transformer. The announcement tone can be set to be heard only at

the paging phone or at both the phone and over the paging system. The TAMB2 allows bi-directional audio, both to and from the paging equipment (in the case of talkback paging equipment). Disconnection of the page happens when the ground start trunk goes on hook and loop current stops. In this mode, the TAMB2 responds to the status of the loop current flow and generally no timers are needed to control when it disconnects. However, a Trunk Timer feature is provided that can help prevent accidental lock-up of the paging system (see feature's description below).

## Trunk Timer Feature:

When interfacing to either loop or ground start trunks, a Trunk Timer feature can be enabled which will interrupt loop current flow to the PBX port for 1 second after either the VOX or Default time has expired. In many PBX systems this break in loop current will cause the connection between the TAMB2 and the calling station to be cleared, allowing another caller to access the paging system. This is designed to protect the

paging system from a phone that may have been hung up incorrectly and is locking out access to the paging system. In addition to enabling this feature, the Default time period must be set and/or the VOX timer must be enabled and its time set. Both timers do not have to be used, but at least one must be enabled for this feature to work.

## Station Port Interfacing:

The TAMB2 answers the station port after it detects high voltage (90V) ring on the line. The unit can be set to answer the call immediately or after the end of the first ring burst. Once answered, the unit provides an announcement tone and connects the telephone line to the paging amplifier through an isolation transformer. The announcement tone can be set to be heard only at the paging phone or at both the phone and over the paging system. The TAMB2 allows bi-directional audio, both to and from the paging equipment (in the case of talkback paging equipment). Since the TAMB2 cannot directly determine the state of the calling party's phone, it must use

indirect methods to determine when to disconnect. Disconnection of the TAMB2 from the call is controlled through 3 methods. 1) A default timer will drop the call after a preset amount of time has elapsed (1-200 seconds), 2) A VOX timer will drop the call after it detects no audio for a preset amount of time (1-11 seconds), 3) The unit will immediately drop the line if it detects a CPC pulse (break in loop current) from the PBX/CO port. Any of these disconnection methods can be inhibited, however at least one must be enabled to ensure that the TAMB2 will disconnect.

## Connections to Paging Amplifier Input

### Balanced Input Wiring:

The TAMB2 was designed to connect to a 600-ohm balanced TEL input. The amplifier's input sensitivity should be high enough that with 200mV input signal, the amp will be able to produce its full rated output power. If input sensitivity is not high enough, try using an unbalanced input with a WMT1A transformer (as shown below).

**IMPORTANT**  
Keep Amp turned off until all wiring to the TAMB2 is complete

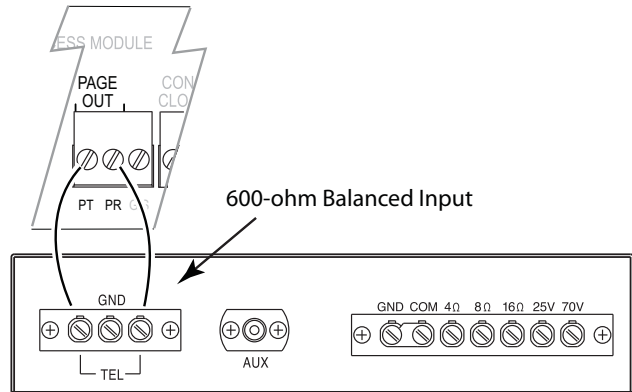

### Unbalanced, Hi-Z Input Wiring:

Wiring to an unbalanced Hi-Z or AUX input normally requires the use of a WMT1A transformer. The output levels of the TAMB2 generally cannot drive this type of input to full rated power since the AUX input is less sensitive than the specialized TEL inputs. The WMT1A provides about a 5X voltage increase in the amp's input.

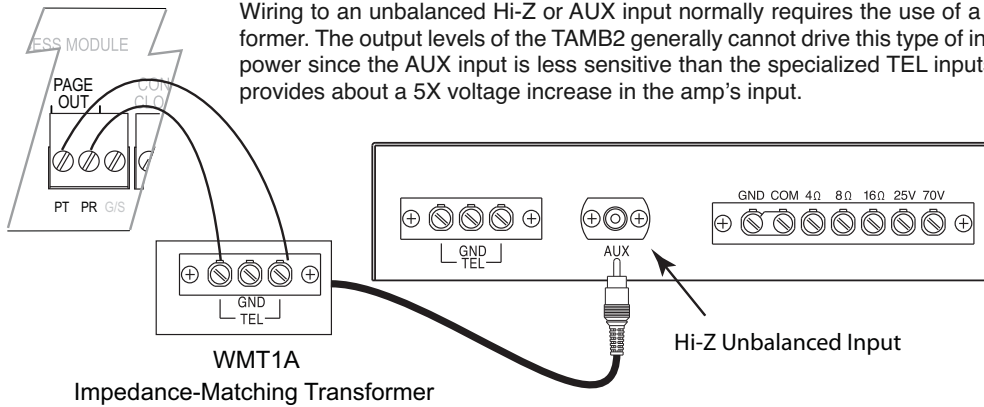

## Connections to Telephone Equipment

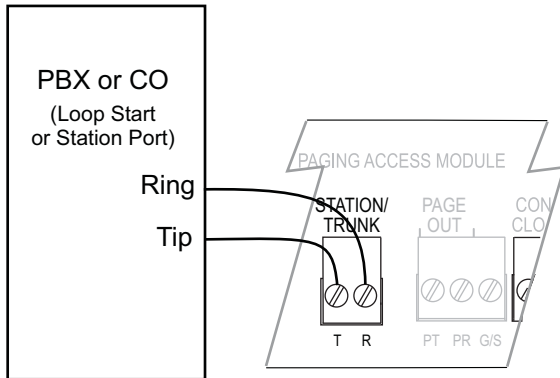

**PBX Loop Start Trunk Port  
CO/PBX Station Port Connections**

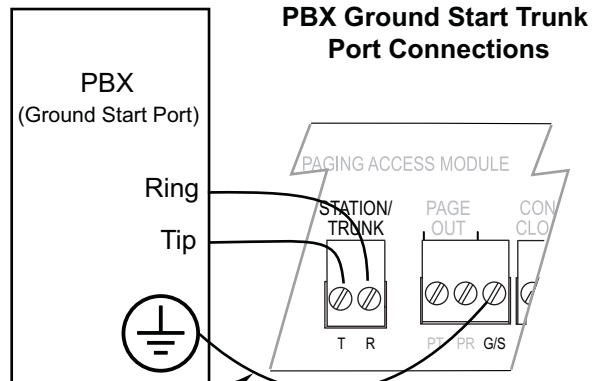

Wiring to the ground start trunk port requires a connection between the TAMB2's G/S terminal and the ground of the PBX. The AC chassis ground for the PBX can typically be used for this connection.

## Connections to a Music Source

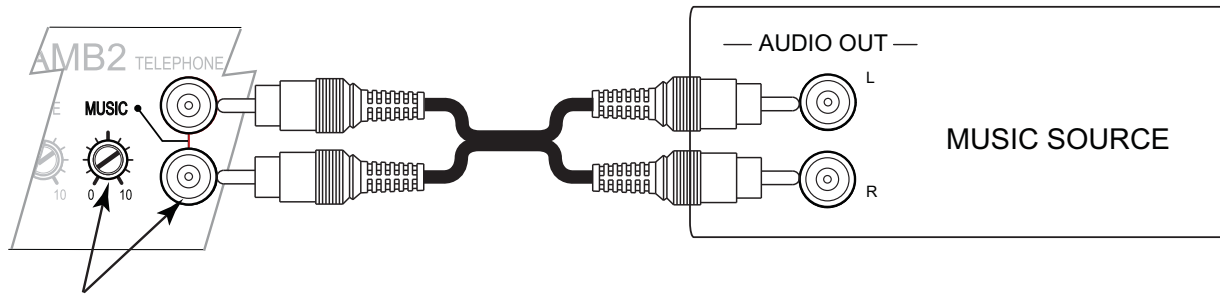

The TAMB2's Music Input will combine a stereo signal into mono or a mono source can be connected to either of the two RCA jacks. The MUSIC control is used to set the level of the music source when playing through the paging system. Set the level of the page using the amplifier's level control, then use the TAMB2 music control to set the background music level.

**IMPORTANT NOTE:** When using the TAMB2 in ground start trunk mode with a music source that uses a 3-prong grounded plug, it may be necessary to use WMT1A transformers to isolate the music sources' outputs from the TAMB2's music inputs. The music source's signal ground, which may be connected to the the AC line ground, could create an electrical short with the connection from the TAMB2's G/S terminal to the PBX ground (which is typically the AC ground for the PBX) causing the TAMB2 not to function.

## Power Supply Connections

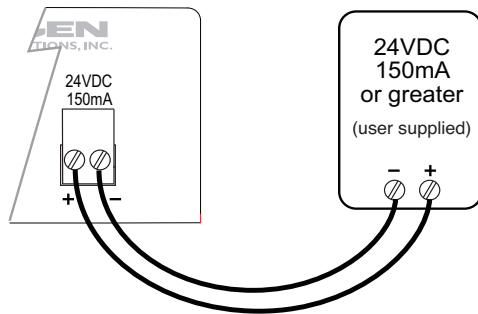

All operational modes of the TAMB2 require the connection of a user-supplied 24V DC power supply. The connection polarity is marked on the unit. The supply input is polarity-protected so that reversed polarity will not damage the unit, but it will not operate until the condition is corrected.

When using multiple TAMB2's in an installation, it may be more convenient to use a single, user-supplied power supply and wire the power terminals of the multiple units together. When doing this, make sure the power supply is 24V DC and can supply 0.15A x the units being powered.

## Rotary Control Functions

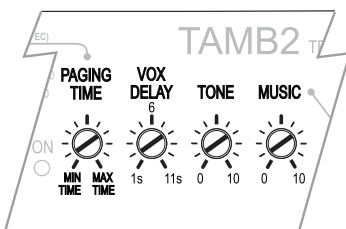

### PAGING TIME

This control is used to set the maximum paging time within the Paging Time Range set by DIP switches 8 & 9. MIN Time is the lowest time of the selected range, MAX Time is the longest time. The control is linear and the "tick" marks represent 5 or 10 second (approx.) intervals, depending on range set, to make setting a specific time simple. The Paging Timer can be inhibited.

### VOX DELAY

This control sets the period of silence that must elapse for the unit to determine that paging activity has likely ended. The "tick" marks represent 1-second (approx.) intervals. This timer can be inhibited.

### TONE

This control sets the level of the audible tone that indicates that the paging connection has been established. The tone cannot be inhibited, but the volume can be turned down so it cannot be heard.

### MUSIC

This control sets the level of an external audio source feeding the paging amplifier when no page is active.

# DIP Switch Settings

## LOOP START TRUNK

Set switches in black as indicated.  
Other switches are at installer's discretion.

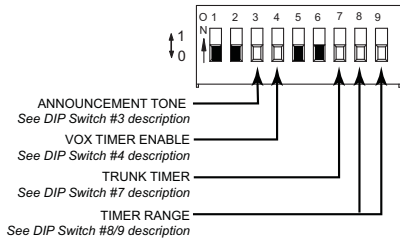

## GROUND START TRUNK

Set switches in black as indicated.  
Other switches are at installer's discretion.

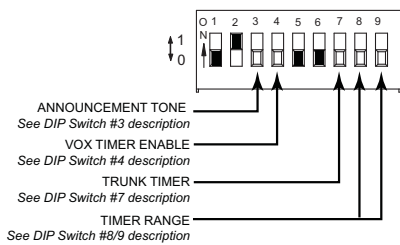

## STATION ACCESS

Set switches in black as indicated.  
Other switches are at installer's discretion.

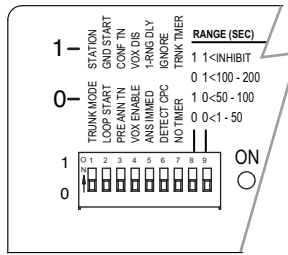
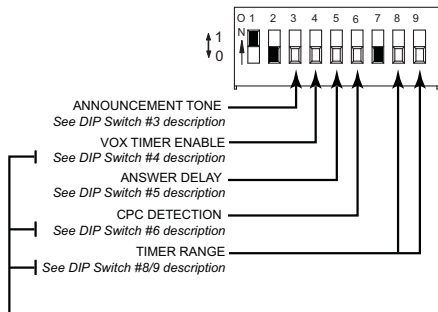

## DIP SW # DIP Switch Function

- 1 Sets unit for either Station access or Trunk (Loop Start and Ground Start) access.
- 2 Determines if Loop Start or Ground Start trunk access will be used.
- 3 Determines if a Pre-Announce tone is to be heard in handset and paging speakers (set to 0) or if a Confirmation tone is to be heard in handset only (set to 1).
- 4 Determines if the VOX timer will operate. Set to 0 to enable the VOX Timer, or 1 to Disable. Only applies to Station Access mode or Trunk Timer feature use.
- 5 Sets unit's delay before answering a station access page to immediate answer (set to 0), or to answer after 1st ring burst (set to 1), (station mode only).
- 6 Sets unit to detect (set to 0), or ignore CPC pulse (set to 1). A CPC pulse is issued by certain equipment when the calling party has hung up (station mode only).
- 7 Determines if the Trunk Timer function will be used (set to 0), or not used (set to 1). See Trunk Timer Features section for description of function.
- 8 / 9 Switches 8 / 9 are used together to set the range for the Paging Time control or to disable the Paging Default timer, 0/0 = 1- 50 sec, 1/0 = 50-100 sec, 0/1 = 100-200 sec, and 1/1 inhibits the timer.

**IMPORTANT NOTE:** DO NOT inhibit all of these disconnect features at once. One of the 3 methods for the TAMB2 to disconnect from a station port must be enabled. If you disable both timers and the CPC-detection, or the PBX/CO does not issue CPC pulses when the calling party hangs up, there will be no means for the TAMB2 to disconnect from the call. You will need to cycle the DC power to the TAMB2 to disconnect the call.

# Contact Closures

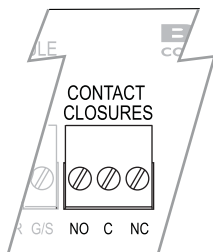

The contact closure contact set is provided to signal to external equipment the TAMB2's operational state. The contact set is single pole, double throw, and changes state from what is screened below the terminals when the TAMB2 becomes active and returns when the unit becomes idle again.

**Contact Ratings:** 0.6A @ 125V AC resistive  
0.6A @ 110V DC resistive  
2.0A @ 30V DC resistive

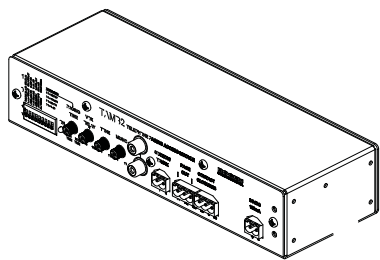

# Specifications

<b>Registration Number:</b>	US: CD2PA13BTAMB2
<b>Ringer Equivalence:</b>	1.3B
<b>Station Port Compatibility:</b>	Two-wire ring start
<b>Trunk Port Compatibility:</b>	Two-wire loop start or ground start
<b>Paging Frequency Response:</b>	200 – 8000 Hz, $\pm 1$ dB
<b>Input/Output Impedance:</b>	600 ohms, nominal
<b>Power Requirements:</b>	24V DC @ 150mA (user-supplied)
<b>Pre-announce/Confirmation Tones:</b>	800 Hz, $\pm 20\%$ , one-half second duration
<b>Default Disconnect Timer:</b>	1 to 200 seconds, adjustable or inhibit
<b>VOX Disconnect Timer:</b>	1 to 11 seconds, adjustable or inhibit
<b>Auxiliary Contact Rating:</b>	0.6A @ 125V AC resistive 0.6A @ 110V DC resistive 2.0A @ 30V DC resistive
<b>Operating Temperature Range:</b>	32° – 120°F.
<b>Connection Method:</b>	Screw terminal
<b>Finish:</b>	Black enclosure with white lettering
<b>Dimensions:</b>	8-1/2" W x 1-3/4" H x 3" D
<b>Shipping Weight:</b>	2 lb.

## Limited Warranty; Exclusion of Certain Damages

The **Bogen TAMB2 Telephone Access Module** is warranted to be free from defects in material and workmanship for two (2) years from the date of sale to the original purchaser. Any part of the product covered by this warranty that, with normal installation and use, becomes defective (as confirmed by Bogen upon inspection) during the applicable warranty period, will be repaired or replaced by Bogen, at Bogen's option, provided the product is shipped insured and prepaid to: Bogen Factory Service Department, 50 Spring Street, Ramsey, NJ 07446, USA. Repaired or replacement product will be returned to you freight prepaid. This warranty does not extend to any of our products that have been subjected to abuse, misuse, improper storage, neglect, accident, improper installation or have been modified or repaired or altered in any manner whatsoever, or where the serial number or date code has been removed or defaced.

**THE FOREGOING LIMITED WARRANTY IS BOGEN'S SOLE AND EXCLUSIVE WARRANTY AND THE PURCHASER'S SOLE AND EXCLUSIVE REMEDY. BOGEN MAKES NO OTHER WARRANTIES OF ANY KIND, EITHER EXPRESS OR IMPLIED, AND ALL IMPLIED WARRANTIES OF MERCHANTABILITY OR FITNESS FOR A PARTICULAR PURPOSE ARE HEREBY DISCLAIMED AND EXCLUDED TO THE MAXIMUM EXTENT ALLOWABLE BY LAW.** Bogen's liability arising out of the manufacture, sale or supplying of products or their use or disposition, whether based upon warranty, contract, tort or otherwise, shall be limited to the price of the product. **IN NO EVENT SHALL BOGEN BE LIABLE FOR SPECIAL, INCIDENTAL OR CONSEQUENTIAL DAMAGES (INCLUDING, BUT NOT LIMITED TO, LOSS OF PROFITS, LOSS OF DATA OR LOSS OF USE DAMAGES) ARISING OUT OF THE MANUFACTURE, SALE OR SUPPLYING OF PRODUCTS, EVEN IF BOGEN HAS BEEN ADVISED OF THE POSSIBILITY OF SUCH DAMAGES OR LOSSES.** Some States do not allow the exclusion or limitation of incidental or consequential damages, so the above limitation or exclusion may not apply to you. This warranty gives you specific legal rights, and you may also have other rights which vary from State to State.

Products that are out of warranty will also be repaired by the Bogen Factory Service Department – same address as above or call 201-934-8500. The parts and labor involved in these repairs are warranted for 90 days when repaired by the Bogen Factory Service Department. All shipping charges in addition to parts and labor charges will be at the owner's expense. All returns require a Return Authorization number. For most efficient warranty or repair service, please include a description of the failure.

12/2008

**BOGEN**<sup>®</sup>  
**COMMUNICATIONS, INC.**

50 Spring Street, Ramsey, NJ 07446, U.S.A.  
Tel. 201-934-8500 • Fax: 201-934-9832  
[www.bogen.com](http://www.bogen.com)