



EUROPEAN
TELECOMMUNICATION
STANDARD

ETS 300 102-1

December 1990

Source: ETSI TC-SPS

Reference: T/S 46-30(CA)

ICS: 33.080

Key words: ISDN, layer 3, basic call control

**Integrated Services Digital Network (ISDN);
User-network interface layer 3
Specifications for basic call control**

ETSI

European Telecommunications Standards Institute

ETSI Secretariat

Postal address: F-06921 Sophia Antipolis CEDEX - FRANCE

Office address: 650 Route des Lucioles - Sophia Antipolis - Valbonne - FRANCE

X.400: c=fr, a=atlas, p=etsi, s=secretariat - **Internet:** secretariat@etsi.fr

Tel.: +33 92 94 42 00 - Fax: +33 93 65 47 16

Copyright Notification: No part may be reproduced except as authorized by written permission. The copyright and the foregoing restriction extend to reproduction in all media.

© European Telecommunications Standards Institute 1990. All rights reserved.

Contents

Foreword.....	11
1 General.....	13
1.1 Scope	13
1.2 Application to interface structures.....	13
2 Overview of call control.....	13
2.1 Circuit switched calls	14
2.1.1 Call states at the user side of the interface.....	14
2.1.1.1 Null state (U0)	14
2.1.1.2 Call initiated (U1)	14
2.1.1.3 Overlap sending (U2)	14
2.1.1.4 Outgoing call proceeding (U3).....	14
2.1.1.5 Call delivered (U4)	14
2.1.1.6 Call present (U6)	14
2.1.1.7 Call received (U7).....	14
2.1.1.8 Connect request (U8).....	14
2.1.1.9 Incoming call proceeding (U9).....	15
2.1.1.10 Active (U10)	15
2.1.1.11 Disconnect request (U11).....	15
2.1.1.12 Disconnect indication (U12)	15
2.1.1.13 Suspend request (U15)	15
2.1.1.14 Resume request (U17).....	15
2.1.1.15 Release request (U19).....	15
2.1.1.16 Overlap receiving (U25).....	15
2.1.2 Network call states.....	15
2.1.2.1 Null state (N0)	15
2.1.2.2 Call initiated (N1)	15
2.1.2.3 Overlap sending (N2)	15
2.1.2.4 Outgoing call proceeding (N3).....	16
2.1.2.5 Call delivered (N4)	16
2.1.2.6 Call present (N6)	16
2.1.2.7 Call received (N7).....	16
2.1.2.8 Connect request (N8).....	16
2.1.2.9 Incoming call proceeding (N9).....	16
2.1.2.10 Active (N10)	16
2.1.2.11 Disconnect request (N11).....	16
2.1.2.12 Disconnect indication (N12)	16
2.1.2.13 Suspend request (N15)	16
2.1.2.14 Resume request (N17).....	16
2.1.2.15 Release request (N19).....	16
2.1.2.16 Call abort (N22).....	17
2.1.2.17 Overlap receiving (N25).....	17
2.2 Packet mode access connections.....	17
2.3 Temporary signalling connections	17
2.4 States associated with the global call reference	17
2.4.1 Call states at the user side of the interface.....	17
2.4.1.1 Null (Rest 0).....	17
2.4.1.2 Restart request (Rest 1)	17
2.4.1.3 Restart (Rest 2)	17
2.4.2 Call states at the network side of the interface	17
2.4.2.1 Null (Rest 0).....	17
2.4.2.2 Restart request (Rest 1)	17
2.4.2.3 Restart (Rest 2)	18

3	Message functional definitions and content	18
3.1	Messages for circuit mode connection control.....	19
3.1.1	Alerting.....	19
3.1.2	Call proceeding	20
3.1.3	Congestion control.....	21
3.1.4	Connect.....	22
3.1.5	Connect acknowledge.....	23
3.1.6	Disconnect.....	23
3.1.7	Facility.....	24
3.1.8	Information.....	24
3.1.9	Notify.....	25
3.1.10	Progress.....	25
3.1.11	Release.....	26
3.1.12	Release complete.....	27
3.1.13	Resume	28
3.1.14	Resume acknowledge.....	28
3.1.15	Resume reject.....	28
3.1.16	Setup	29
3.1.17	Setup acknowledge	31
3.1.18	Status.....	32
3.1.19	Status enquiry	32
3.1.20	Suspend	33
3.1.21	Suspend acknowledge	33
3.1.22	Suspend reject	34
3.1.23	User information	34
3.2	Messages for packet mode connection control	34
3.3	Messages for user to user signalling not associated with circuit switched calls	35
3.4	Messages used with the global call reference.....	35
3.4.1	Restart	35
3.4.2	Restart acknowledge.....	35
3.4.3	Status.....	36
4	General message format and information elements coding	37
4.1	Overview	37
4.2	Protocol discriminator	37
4.3	Call reference	38
4.4	Message type.....	40
4.5	Other information elements	41
4.5.1	Coding Rules.....	41
4.5.1.1	Codeset 0	43
4.5.1.2	Codeset 5	45
4.5.2	Extensions of codesets	45
4.5.3	Locking shift procedure	46
4.5.4	Non-locking shift procedure	47
4.5.5	Bearer capability	48
4.5.6	Call Identity.....	56
4.5.7	Call State.....	57
4.5.8	Called party number	58
4.5.9	Called party subaddress	60
4.5.10	Calling Party Number	62
4.5.11	Calling party subaddress.....	63
4.5.12	Cause.....	65
4.5.13	Channel identification	73
4.5.14	Congestion level	76
4.5.15	Display	76
4.5.16	High layer compatibility	76
4.5.17	Keypad facility.....	80
4.5.18	Low layer compatibility.....	80
4.5.19	More data.....	89
4.5.20	Network-specific facilities.....	90

4.5.21	Notification indicator	91
4.5.22	Progress indicator	91
4.5.23	Repeat indicator	92
4.5.24	Restart indicator.....	92
4.5.25	Segmented message.....	93
4.5.26	Sending complete.....	94
4.5.27	Signal.....	94
4.5.28	Transit network selection	95
4.5.29	User-user	96
4.6	Supplementary services information elements.....	98
4.6.1	Date/time.....	98
4.6.2	Facility.....	98
4.6.2.1	Invoke component.....	102
4.6.2.1.1	Operation-specific fields for user-user information supplementary service.	103
4.6.2.2.2	Return result component.....	106
4.6.2.3	Return error component	107
4.6.3	Feature activation.....	108
4.6.4	Feature indication	108
4.6.5	Switchhook	108
4.7	Information elements for packet communications	109
5	Circuit switched call control procedures.....	110
5.1	Call establishment at the originating interface	111
5.1.1	Call request	111
5.1.2	B-channel selection - originating.....	111
5.1.3	Overlap sending	112
5.1.4	Invalid call information.....	113
5.1.5	Call proceeding	113
5.1.5.1	Call proceeding, en-bloc sending.....	113
5.1.5.2	Call proceeding, overlap sending.....	114
5.1.6	Notification of interworking at the originating interface.	115
5.1.7	Call confirmation indication	115
5.1.8	Call connected	116
5.1.9	Call rejection.....	116
5.1.10	Transit network selection	116
5.2	Call establishment at the destination interface	116
5.2.1	Incoming call.....	116
5.2.2	Compatibility checking	117
5.2.3	B-channel selection-destination.....	118
5.2.3.1	SETUP message delivered by point-to-point data link.....	118
5.2.3.2	SETUP message delivered by broadcast data link.....	119
5.2.4	Overlap receiving	119
5.2.5	Call confirmation.....	120
5.2.5.1	Response to en-bloc SETUP or completion of overlap receiving	120
5.2.5.2	Receipt of CALL PROCEEDING and ALERTING	121
5.2.5.3	Called user clearing during incoming call establishment....	122
5.2.5.4	Call failure.....	123
5.2.6	Notification of interworking at the terminating interface	124
5.2.7	Call accept	124
5.2.8	Active indication	125
5.2.9	Non-selected user clearing.....	125
5.3	Call clearing.....	125
5.3.1	Terminology	125
5.3.2	Exception conditions	125
5.3.3	Clearing initiated by the user	126
5.3.4	Clearing initiated by the network.....	127
5.3.4.1	Clearing when tones/announcements provided	127
5.3.4.2	Clearing when tones/announcements not provided.....	128

	5.3.4.3	Completion of clearing.....	128
	5.3.5	Clear collision.....	128
5.4		In-band tones and announcements.....	128
5.5		Restart procedure.....	129
	5.5.1	Sending RESTART.....	129
	5.5.2	Receipt of RESTART.....	130
5.6		Call rearrangements.....	131
	5.6.1	Call suspension.....	131
	5.6.2	Call suspended.....	131
	5.6.3	Call suspend error.....	132
	5.6.4	Call re-establishment.....	132
	5.6.5	Call resume errors.....	133
	5.6.6	Double suspension.....	133
	5.6.7	Call re-arrangement notification controlled by an NT2.....	133
5.7		Call collisions.....	133
5.8		Handling of error conditions.....	134
	5.8.1	Protocol discrimination error.....	134
	5.8.2	Message too short.....	134
	5.8.3	Call reference error.....	134
	5.8.3.1	Invalid call reference format.....	134
	5.8.3.2	Call reference procedural errors.....	134
	5.8.4	Message type or message sequence errors.....	135
	5.8.5	General information element errors.....	135
	5.8.5.1	Information element out of sequence.....	136
	5.8.5.2	Duplicated information elements.....	136
	5.8.6	Mandatory information element errors.....	136
	5.8.6.1	Mandatory information element missing.....	136
	5.8.6.2	Mandatory information element content error.....	136
	5.8.7	Non-mandatory information element errors.....	137
	5.8.7.1	Unrecognized information element.....	137
	5.8.7.2	Non-mandatory information element content error.....	138
	5.8.8	Data link reset.....	138
	5.8.9	Data link failure.....	138
	5.8.10	Status enquiry procedure.....	139
	5.8.11	Receiving a STATUS message.....	140
5.9		User notification procedure.....	141
6		Packet communication procedures.....	141
7		User-to user signalling procedures.....	141
	7.1	Procedures for user-to-user signalling associated with circuit-switched calls.....	141
	7.1.1	General.....	141
	7.1.2	Explicit invocation procedures for services 1, 2, and 3.....	141
	7.1.3	User-to-User Signalling Service 1.....	142
	7.1.3.1	General characteristics.....	142
	7.1.3.2	User-to-user signalling in the call setup and clearing phases - Implicit service request (preferred, i.e. not required).....	143
	7.1.3.3	User-to-user signalling in the call establishment setup and clearing phases - Explicit service request (preferred or required).....	143
	7.1.3.4	Interworking.....	144
	7.1.3.5	Rejection of implicit service requests.....	144
	7.1.3.6	Rejection of explicit service requests.....	144
	7.1.3.7	User-to-user signalling in the call clearing phase.....	144
	7.1.3.8	Unexpected user-user information in call control messages.....	145
	7.1.4	User-to-user signalling service 2.....	145
	7.1.4.1	General characteristics.....	145
	7.1.4.2	Call establishment.....	145
	7.1.4.3	Service rejection.....	146

	7.1.4.4	Transfer of USER INFORMATION messages	146
7.1.5		User-to-user signalling service 3	146
	7.1.5.1	General	146
	7.1.5.2	Service request during call establishment.....	146
	7.1.5.3	Rejection of service request during call establishment.....	147
	7.1.5.4	Service request after call establishment.....	147
	7.1.5.5	Rejection of service request after call establishment.....	147
	7.1.5.6	Transfer of USER INFORMATION messages	147
	7.1.5.7	Congestion control of USER INFORMATION messages ..	148
7.1.6		Unexpected USER INFORMATION messages.....	148
	7.1.6.1	Receipt of USER INFORMATION messages in incompatible call states	148
	7.1.6.2	Receipt of unexpected USER INFORMATION messages.	148
7.1.7		Requesting user-to-user signalling services 1, 2 and 3.....	148
	7.1.7.1	General	148
	7.1.7.2	Call establishment.....	148
	7.1.7.3	Service rejection.....	148
	7.1.7.4	Transfer of USER INFORMATION messages	149
7.1.8		Summary of actions to be taken by the called side and subsequent network action	149
7.2		Procedures for user-to-user signalling not associated with circuit-switched calls.....	151
8		Application of circuit-switched supplementary services to terminals using stimulus procedures....	151
9		List of system parameters	151
	9.1	Timers in the Network Side	151
	9.2	Timers in the User side.....	151
Annex A (Informative): User side and network side SDL diagrams.....			158
Annex B (Normative): Compatibility checking			158
B.1		Introduction.....	158
B.2		Calling side compatibility checking	158
B.3		Called side compatibility checking	158
	B.3.1	Compatibility checking with addressing information	158
	B.3.2	Network-to user compatibility checking	159
	B.3.3	User-to-user compatibility checking.....	159
	B.3.4	User action tables	160
B.4		Interworking with existing networks.....	161
Annex C (Normative): Transit network selection			161
C.1		Selection not supported	161
C.2		Selection supported.....	161
Annex D (Informative): Extension for symmetric call operation			162
D.1		Additional message handling	162
	D.1.1	B-channel selection - symmetric interface.....	162
	D.1.2	Call confirmation	163
	D.1.3	Clearing by the called user employing user provided tones/announcements.....	163
	D.1.4	Active indication	163
D.2		Timers for call establishment.....	163

D.3	Call collisions	163
Annex E (Normative):	Network specific facility selection	164
E.1	Default provider.....	164
E.2	Routing not supported.....	164
E.3	Routing supported	164
Annex F (Informative):	D-Channel backup procedures	165
Annex G (Informative):	Cause definitions.....	165
G.1	Normal class	165
G.1.1	Cause #1 "unallocated (unassigned) number"	165
G.1.2	Cause #2 "no route to specifies transit network"	165
G.1.3	Cause #3 "no route to destination".....	165
G.1.4	Cause #6 "channel unacceptable"	165
G.1.5	Cause #7 "call awarded and being delivered in an established channel"	165
G.1.6	Cause #16 "normal call clearing".....	165
G.1.7	Cause #17 "user busy"	165
G.1.8	Cause #18 "no user responding".....	166
G.1.9	Cause #19 "no answer from user (user alerted)".....	166
G.1.10	Cause #21 "call rejected"	166
G.1.11	Cause #22 "number changed"	166
G.1.12	Cause #26 "non-selected user clearing"	166
G.1.13	Cause #27 "destination out of order".....	166
G.1.14	Cause #28 "invalid format (address incomplete)"	166
G.1.15	Cause #29 "facility rejected".....	166
G.1.16	Cause #30 "response to status enquiry".....	166
G.1.17	Cause #31 "normal, unspecified"	166
G.2	Resource unavailable class	166
G.2.1	Cause #34 "no circuit/channel available".....	166
G.2.2	Cause #38 "network out of order"	167
G.2.3	Cause #41 "temporary failure".....	167
G.2.4	Cause #42 "switching equipment congestion".....	167
G.2.5	Cause #43 "access information discarded".....	167
G.2.6	Cause #44 "requested circuit/channel not available"	167
G.2.7	Cause #47 "resource unavailable, unspecified"	167
G.3	Service or option not available class.....	167
G.3.1	Cause #49 "quality of service not available".....	167
G.3.2	Cause #50 "requested facility not subscribed"	167
G.3.3	Cause #57 "bearer capability not authorised".....	167
G.3.4	Cause #58 "bearer capability not presently available".....	167
G.3.5	Cause #63 "service or option not available "unspecified".....	167
G.4	Service or option not implemented class.....	168
G.4.1	Cause #65 "bearer capability not implemented"	168
G.4.2	Cause #66 "channel type not implemented"	168
G.4.3	Cause #69 "requested facility not implemented".....	168
G.4.4	Cause #70 "only restricted digital information bearer capability is available".....	168
G.4.5	Cause #79 "service or option not implemented, unspecified"	168
G.5	Invalid message (e.g. parameter out of range) class	168
G.5.1	Cause #81 "invalid call reference value"	168
G.5.2	Cause #82 "identified channel does not exist"	168
G.5.3	Cause #83 "a suspended call exists, but this call identity does not"	168

G.5.4	Cause #84 "call identity in use"	168
G.5.5	Cause #85 "no call suspended"	168
G.5.6	Cause #86 "call having the requested call identity has been cleared"	169
G.5.7	Cause #88 "incompatible destination"	169
G.5.8	Cause #91 "invalid transit network selection"	169
G.5.9	Cause #95 "invalid message, unspecified"	169
G.6	Protocol error (e.g. unknown message) class	169
G.6.1	Cause #96 "mandatory information element is missing"	169
G.6.2	Cause #97 "message type non-existent or not implemented"	169
G.6.3	Cause #98 "message not compatible with call state or messages TYPE NON-EXISTENT OR NOT IMPLEMENTED"	169
G.6.4	Cause #99 "information element non-existent or not implemented"	169
G.6.5	Cause #100 "invalid information element contents"	169
G.6.6	Cause #101 "message not compatible with call start"	169
G.6.7	Cause #102 "recovery on timer expiry"	170
G.6.8	Cause #111 "protocol error, unspecified"	170
G.7	Interworking class	170
G.7.1	Cause #127 "interworking, unspecified"	170
Annex H (Informative):	Examples of information elements coding	171
H.1	Bearer capability information element	171
H.1.1	Coding for speech	171
H.1.2	Coding for 3.1 kHz audio	171
H.1.3	Coding for unrestricted digital information	172
H.1.4	Coding for case B X.31 packet mode access connections	172
H.2	Channel identification information element	173
H.2.1	Basic interface, circuit mode, B-channel	173
H.2.2	Primary rate interface, circuit mode, B-channel	173
H.2.3	Primary rate interface, circuit mode, H0-channel	175
H.2.4	Channel selection for the support of the 2x64 kbit/s bearer service (ETSI networks)	176
H.2.4.1	Basic interface, circuit mode, 2x64 kbit/s bearer service	176
H.2.4.2	Primary rate interface, circuit mode, 2x64 kbit/s bearer service	177
H.3	Called/calling party subaddress information element	177
H.3.1	Coding of IA5 subaddress digits	177
Annex I (Normative):	Use of progress indicators	177
Annex J (Normative):	Examples of cause value and location for busy condition	178
Annex K (Normative):	Message segmentation procedures	180
K.1	Introduction	180
K.2	Message segmentation	180
K.3	Reassembly of segmented messages	181
Annex L (Normative):	Low layer information coding principles	188
L.1	Purpose	188
L.2	Principles	188
L.2.1	Definitions of types of information	188
L.2.2	Examination by the network	189
L.2.3	Location of type I information	189

L.2.4	Location of types II and III information	189
L.2.5	Relationship between bearer capability and low layer compatibility information elements	189
L.3	Information classification	190
L.3.1	Examples for search and 3.1 kHz audio bearer services	190
L.3.2	Examples for 64 kbit/s UDI circuit mode bearer service	190
L.3.3	Examples for ISDN virtual-circuit bearer service	191
L.4	Scenarios outside the scope of ISDN standardization	193
L.4.1	Examples for speech and 3.1 kHz audio bearer services	193
L.4.2	Examples for 64 kbit/s UDI circuit mode bearer services	193
Annex M (Normative):	Low layer compatibility negotiation	194
M.1	General	194
M.2	Low layer capability notification to the called user	194
M.3	Low layer capability negotiation between users	194
M.4	Low layer compatibility negotiation options	195
Annex N (Normative):	Procedures for establishment of bearer connection prior to call acceptance...	195
N.1	General	195
N.2	Procedures	195
Annex O (Informative):	Optional procedures for bearer service change	196
Annex P (Informative):	Formal Definitions for the Facility information element	197
Appendix I (Informative):	(to ETS 300 102-1): Usage of cause values	200
Appendix II (Informative):	(to ETS 300 102-1): Example message flow diagrams and example conditions for cause mapping	209
Appendix III (Informative):	(to ETS 300 102-1): Summary of assigned information element identifier and message type code points for the T/S 46-XX series of ETSS.....	210
History	213

Foreword

This European Telecommunications Standard (ETS) was produced by the Signalling, Protocols and Switching (SPS) Technical Committee of the European Telecommunications Standards Institute (ETSI), and was adopted, having passed through the ETSI standards approval procedure.

This document is part 1 of a multi-part ETS, comprised as follow:

ETS 300 102-1: ISDN; User-network interface layer 3; Specifications for basic call control.

ETS 300 102-2: ISDN; User-network interface layer 3; Specifications for basic call control; Specification Description Language (SDL) diagrams.

This ETS is based on CCITT [Blue book: 1988] Recommendation Q.931 and provides modifications and further requirements to this base document.

Throughout this ETS, deviations from CCITT Recommendation Q.931 are indicated by means of either "additional" or "struck out" text. ETSI specific requirements are prefixed by "ETSI Requirement:".

Blank page

1 General

This standard specifies the procedures for the establishing, maintaining and clearing of network connections at the ISDN user-network interface. These procedures are defined in terms of messages exchanged over the D-channel of basic and primary rate interface structures. The functions and procedures of this protocol, and the relationship with other layers, are described in general terms in CCITT Recommendation Q.930 (I.450).

1.1 Scope

This standard specifies the generic layer three protocol for the control of circuit-switched on demand connections serving ISDN customers via the user-network interface for a variety of applications. These applications are, e.g., the connection of terminals or private ISDNs to the public network applying the point-to-point or the point-to-multipoint mode of operation.

The purpose of this standard is to present the generic layer three signalling requirements for the user-network interfaces.

This standard specifies the stage three of the pan-European Integrated Services Digital Network (ISDN) as provided by European telecommunication operators for the basic call control at the T reference point or coincident S and T reference points (as defined in CCITT Recommendation I.411) by means of the Digital Subscriber Signalling one (DSS1).

This standard specifies the protocol requirements where the service is provided to the user within an ISDN; it does not specify the additional protocol requirements where the service is provided to the user via a telecommunication network that is not an ISDN.

The basic call control according to this standard is applicable to the telecommunication services as described in the appropriate stage one standards

Further standards specify the method of testing and detailed application specific requirements to determine conformance based on this standard.

1.2 Application to interface structures

The layer 3 procedures apply to the interface structures defined in CCITT Recommendation I.412. They use the functions and services provided by layer 2. The unacknowledged information transfer service is used by layer 3 to provide point-to-multipoint operation as described in §5.2.

The layer 3 procedures request the services of layer 2 and receive information from layer 2 using the primitives defined in ETS 300 125. These primitives are used to illustrate the communication between the protocol layers and are not intended to specify or constrain implementations.

2 Overview of call control

In this standard the terms "incoming" and "outgoing" are used to describe the call as viewed by the user side of the interface.

In the paragraphs which follow states are defined for circuit switched calls in §2.1 (call states), for packet mode access connections in §2.2 (access connection states), for temporary signalling connections in §2.3 (call states) and for the interface in §2.4 (global call reference states).

This paragraph defines the basic call control states that individual calls may have. These definitions do not apply to the state of the interface itself, any attached equipment, the D-Channel, or the logical links used for signalling on the D-Channel. Because several calls may exist simultaneously at a user-network interface and each call may be in a different state, the state of the interface itself cannot be unambiguously defined.

NOTE: Additional states and SDL diagrams may be defined when new procedures are developed.

Detailed description of the procedures for call control are given in §§5, 6, 7 and 8 in terms of: (a) the messages defined in §3 which are transferred across the user-network interface; and (b) the information processing and actions that take place at the user side and the network side. Overview and Detailed SDL diagrams for call control of circuit switched calls are contained in ETS 300 102-2.

Throughout this standard, references are made to B-Channels. For services using H-Channels, the references to B-Channels should be taken to refer to the appropriate H-Channel. Further study may be needed on other enhancements to support such services.

2.1 Circuit switched calls

This paragraph defines the basic call control states for circuit switched calls. The procedures for call control are given in §5.

Annex D contains optional procedures (as an extension to the basic procedures) to allow symmetric signalling. These states are defined in Annex D.

2.1.1 Call states at the user side of the interface

The states which may exist on the user side of the user-network interface are defined in this paragraph.

2.1.1.1 Null state (U0)

No call exists.

2.1.1.2 Call initiated (U1)

This state exists for an outgoing call, when the user requests call establishment from the network.

2.1.1.3 Overlap sending (U2)

This state exists for an outgoing call when the user has received acknowledgement of the call establishment request which permits the user to send additional call information to the network in overlap mode.

2.1.1.4 Outgoing call proceeding (U3)

This state exists for an outgoing call when the user has received acknowledgement that the network has received all call information necessary to effect call establishment.

2.1.1.5 Call delivered (U4)

This state exists for an outgoing call, when the calling user has received an indication that remote user alerting has been initiated.

2.1.1.6 Call present (U6)

This state exists for an incoming call when the user has received a call establishment request but has not yet responded.

2.1.1.7 Call received (U7)

This state exists for an incoming call when the user has indicated alerting but has not yet answered.

2.1.1.8 Connect request (U8)

This state exists for an incoming call when the user has answered the call and is waiting to be awarded the call.

2.1.1.9 Incoming call proceeding (U9)

This state exists for an incoming call when the user has sent acknowledgement that the user has received all call information necessary to effect call establishment.

2.1.1.10 Active (U10)

This state exists for an incoming call when the user has received an acknowledgement from the network that the user has been awarded the call. This state exists for an outgoing call when the user has received an indication that the remote user has answered the call.

2.1.1.11 Disconnect request (U11)

This state exists when the user has requested the network to clear the end-to-end connection (if any) and is waiting for a response.

2.1.1.12 Disconnect indication (U12)

This state exists when the user has received an invitation to disconnect because the network has disconnected the end-to-end connection (if any).

2.1.1.13 Suspend request (U15)

This state exists when the user has requested the network to suspend the call and is waiting for a response.

2.1.1.14 Resume request (U17)

This state exists when the user has requested the network to resume a previously suspended call and is waiting for a response.

2.1.1.15 Release request (U19)

This state exists when the user has requested the network to release and is waiting for a response.

2.1.1.16 Overlap receiving (U25)

This state exists for an incoming call when the user has acknowledged the call establishment request from the network and is prepared to receive additional call information (if any) in overlap mode.

2.1.2 Network call states

ETSI Requirement: _____ This paragraph refers to the call states at the network side of the interface.

The call states that may exist on the network side of the user-network interface are defined in this paragraph.

2.1.2.1 Null state (N0)

No call exists.

2.1.2.2 Call initiated (N1)

This state exists for an outgoing call when the network has received a call establishment request but has not yet responded.

2.1.2.3 Overlap sending (N2)

This state exists for an outgoing call when the network has acknowledged the call establishment request and is prepared to receive additional call information (if any) in overlap mode.

2.1.2.4 Outgoing call proceeding (N3)

This state exists for an outgoing call when the network has sent acknowledgement that the network has received all call information necessary to effect call establishment.

2.1.2.5 Call delivered (N4)

This state exists for an outgoing call when the network has indicated that remote user alerting has been initiated.

2.1.2.6 Call present (N6)

This state exists for an incoming call when the network has sent a call establishment request but has not yet received a satisfactory response.

2.1.2.7 Call received (N7)

This state exists for an incoming call when the network has received an indication that the user is alerting but has not yet received an answer.

2.1.2.8 Connect request (N8)

This state exists for an incoming call when the network has received an answer but the network has not yet awarded the call.

2.1.2.9 Incoming call proceeding (N9)

This state exists for an incoming call when the network has received acknowledgement that the user has received all call information necessary to effect call establishment.

2.1.2.10 Active (N10)

This state exists for an incoming call when the network has awarded the call to the called user. This state exists for an outgoing call when the network has indicated that the remote user has answered the call.

2.1.2.11 Disconnect request (N11)

This state exists when the network has received a request from the user to clear the end-to-end connection (if any).

2.1.2.12 Disconnect indication (N12)

This state exists when the network has disconnected the end-to-end connection (if any) and has sent an invitation to disconnect the user-network connection.

2.1.2.13 Suspend request (N15)

This state exists when the network has received a request to suspend the call but has not yet responded.

2.1.2.14 Resume request (N17)

This state exists when the network has received a request to resume a previously suspended call but has not yet responded.

2.1.2.15 Release request (N19)

This state exists when the network has requested the user to release and is waiting for a response.

2.1.2.16 Call abort (N22)

This state exists for an incoming call for the point-to-multipoint configuration when the call is being cleared before any user has been awarded the call.

2.1.2.17 Overlap receiving (N25)

This state exists for an incoming call when the network has received acknowledgement of the call establishment request which permits the network to send additional call information (if any) in the overlap mode.

2.2 Packet mode access connections

ETSI Requirement: The basic packet-mode access connection control states for access to the ISDN virtual circuit bearer service are defined in ETSI ETS 300 007.

2.3 Temporary signalling connections

ETSI Requirement: The basic call control states for user-to-user signalling not associated with circuit switched calls is outside the scope of this issue of this ETS.

2.4 States associated with the global call reference

This paragraph defines the states that the protocol may adopt using the global call reference. The procedures for use of the global call reference for RESTART are contained in §5.5

There is only one global call reference per interface.

2.4.1 Call states at the user side of the interface

The states which may exist on the user side of the user-network interface are defined in this paragraph.

2.4.1.1 Null (Rest 0)

No transaction exists.

2.4.1.2 Restart request (Rest 1)

This state exists for a restart transaction when the user has sent a restart request but has not yet received an acknowledgement response from the network.

2.4.1.3 Restart (Rest 2)

This state exists when a request for a restart has been received from the network and responses have not yet been received from all locally active call references.

2.4.2 Call states at the network side of the interface

The states which may exist on the network side of the user-network interface are defined in this paragraph.

2.4.2.1 Null (Rest 0)

No transaction exists.

2.4.2.2 Restart request (Rest 1)

This state exists for a restart transaction when the network has sent a restart but has not yet received an acknowledgement response from the user.

2.4.2.3 Restart (Rest 2)

This state exists when a request for a restart has been received from the user and a response has not yet been received from all locally active call references.

3 Message functional definitions and content

This paragraph provides an overview of the ETS 300 102-1 message structure which highlights the functional definition and information content (i.e. semantics) of each message. Each definition includes:

- a) a brief description of the message direction and use, including whether the message has:
 - [1] local significance, i.e. relevant only in the originating or terminating access;
 - [2] access significance, i.e. relevant in the originating and terminating access, but not in the network;
 - [3] dual significance, i.e. relevant in either the originating or the terminating access and in the network; or,
 - [4] global significance, i.e. relevant in the originating and terminating access and in the network.
- b) a table listing the codeset 0 information elements in the order of their appearance in the message (same relative order for all message types). For each information element the table indicates:
 - [1] the section of this ETS describing the information element;
 - [2] the direction which it may be sent; i.e. user-to-network ("u → n"), network-to-user ("n → u"), or both;

NOTE: The user-network terminology in §3 refers to the TE-ET, TE-NT2, and NT2-ET interface structures. Annex D contains a description of the information element usage for symmetric NT2-NT2 interfaces.

- [3] whether inclusion is mandatory ("M") or optional ("O") with a reference to notes explaining the circumstances under which the information element shall be included;
- [4] the length of the information element (or permissible range of lengths), in octets, where "*" denotes an undefined maximum length, which may be network or service dependent.

NOTE: All messages may contain information elements from codesets 5, 6 and 7 and corresponding locking and non-locking shift information elements which comply with the coding rules specified in §§4.5.2-4.5.4. None of these information elements, however, are listed in any of the tables in §3.

- c) further explanatory notes, as necessary.

3.1 Messages for circuit mode connection control

Table 3.1 summarizes the messages for circuit mode connection control.

Table 3.1: Messages for circuit mode connection control

	Reference
Call establishment messages: ALERTING CALL PROCEEDING CONNECT CONNECT ACKNOWLEDGE PROGRESS SETUP SETUP ACKNOWLEDGE	 3.1.1 3.1.2 3.1.4 3.1.5 3.1.10 3.1.16 3.1.17
Call information phase messages: RESUME RESUME ACKNOWLEDGE RESUME REJECT SUSPEND SUSPEND ACKNOWLEDGE SUSPEND REJECT USER INFORMATION	 3.1.13 3.1.14 3.1.15 3.1.20 3.1.21 3.1.22 3.1.23
Call clearing messages: DISCONNECT RELEASE RELEASE COMPLETE	 3.1.6 3.1.11 3.1.12
Miscellaneous messages SEGMENT (ETSI Requirement) CONGESTION CONTROL FACILITY INFORMATION NOTIFY STATUS STATUS ENQUIRY	 Annex K 3.1.3 3.1.7 3.1.8 3.1.9 3.1.18 3.1.19

ETSI Requirement: _____ Not included in the list of CCITT Recommendation Q.931.

3.1.1 Alerting

This message is sent by the called user to the network and by the network to the calling user to indicate that called user alerting has been initiated. See table 3.2.

Table 3.2: ALERTING message content

Message Type: ALERTING
Significance: global
Direction: both

Information Element	Reference	Direction	Type	Length
Protocol discriminator	4.2	both	M	1
Call reference	4.3	both	M	2 - 3
Message type	4.4	both	M	1
Channel identification	4.5	both (NOTE 10)	0 (NOTE 1)	2 - *
Facility	4.6	both	0 (NOTE 9)	2 - *
Progress indicator	4.5	both	0 (NOTE 2)	2 - 4
Display	4.5	n -> u	0 (NOTE 3)	2 - 34
User-user	4.5	both	0 (NOTE 7)	NOTE 8

NOTE 1: Mandatory if this message is the first message in response to SETUP, unless the user accepts the B-Channel indicated in the SETUP message.

NOTE 2: Included in the event of interworking. Included in the network-to-user direction in connection with the provision of in-band information/patterns. Included in the user-to-network direction in connection with the provision of in-band information/patterns if Annex N is implemented.

NOTE 3: Included if the network provides information that can be presented to the user.

NOTE 4: Spare in ETSI ETS.

NOTE 5: Spare in ETSI ETS.

NOTE 6: Spare in ETSI ETS.

NOTE 7: Included in the user-to-network direction when the called user wants to return information to the calling user, or in the network-to-user direction if the called user included a User-user information element in the ALERTING message. Conditions for this transfer are described in §7.

NOTE 8: The minimum length is 2 octets: The default standard maximum length is 131 octets.

NOTE 9: May be used for functional operation of supplementary services, (see §7).

NOTE 10: Included in the network-to-user direction for support of the procedures in Annex D.

3.1.2 Call proceeding

This message is sent by the called user to the network or by the network to the calling user to indicate that the requested call establishment has been initiated and no more call establishment information will be accepted. See table 3.3.

Table 3.3: Call proceeding message content

Message type: CALL PROCEEDING
Significance: local
Direction: both

Information Element	Reference	Direction	Type	Length
Protocol discriminator	4.2	both	M	1
Call reference	4.3	both	M	2 - 3
Message type	4.4	both	M	1
Channel identification	4.5	both	0 (NOTE 1)	2 - *
Progress indicator	4.5	both	0 (NOTE 2)	2 - 4
Display	4.5	n -> u	0 (NOTE 3)	2 - 34

NOTE 1: Mandatory in the network-to-user direction if this message is the first message in response to SETUP. Mandatory in the user-to-network direction if this message is the first message in response to SETUP, unless the user accepts the B-Channel indicated in the SETUP message.

NOTE 2: Included in the event of interworking. Included in the network-to-user direction in connection with the provision of in-band information/patterns. Included in the user-to-network direction in connection with the provision of in-band information/patterns if Annex N is implemented.

NOTE 3: Included if the network provides information that can be presented to the user.

3.1.3 Congestion control

This message is sent by the user or the network to indicate the establishment or termination of flow control on the transmission of USER INFORMATION messages. See table 3.4.

Table 3.4: Congestion control message content

Message Type: CONGESTION CONTROL
Significance: local (Note 1)
Direction: both

Information Element	Reference	Direction	Type	Length
Protocol discriminator	4.2	both	M	1
Call reference	4.3	both	M	2 - 3
Message type	4.4	both	M	1
Congestion level	4.5	both	M	1
Cause	4.5	both	0 (NOTE 2)	2 - 32
Display	4.5	n -> u	0 (NOTE 3)	2 - 34

NOTE 1: This message has local significance, but may carry information of global significance.

NOTE 2: Included if user to user information has been discarded as a result of a congestion situation.

NOTE 3: Included if the network provides information that can be presented to the user.

3.1.4 Connect

This message is sent by the called user to the network and by the network to the calling user to indicate call acceptance by the called user. See table 3.5.

Table 3.5: Connect message content

Message Type: CONNECT
Significance: global
Direction: both

Information Element	Reference	Direction	Type	Length
Protocol discriminator	4.2	both	M	1
Call reference	4.3	both	M	2 - 3
Message type	4.4	both	M	1
Channel identification	4.5	both (NOTE 11)	O (NOTE 1)	2 - *
Facility	4.6	both	O (NOTE 2)	2 - *
Progress indicator	4.5	both	O (NOTE 3)	2 - 4
Display	4.5	n -> u	O (NOTE 4)	2 - 34
Date/Time	4.6	n -> u	O (NOTE 12)	2 - 7
Low Layer compatibility	4.5	both	O (NOTE 8)	2 - 16
User-user	4.5	both	O (NOTE 9)	NOTE 10

NOTE 1: Mandatory if this message is the first message in response to SETUP, unless the user accepts the B-Channel indicated in the SETUP message.

NOTE 2: May be used for functional operation of supplementary services.

NOTE 3: Included in the event of interworking or in connection with the provision of in-band information/patterns.

NOTE 4: Included if the network provides information that can be presented to the user.

NOTE 5: Spare in ETSI ETS.

NOTE 6: Spare in ETSI ETS.

NOTE 7: Spare in ETSI ETS.

NOTE 8: Included in the user-to-network direction when the answering user wants to return low layer compatibility information to the calling user. Included in the network-to-user direction if the user awarded the call included a Low layer compatibility information element in the CONNECT message. Optionally included for low layer compatibility negotiation, but some networks may not transport this information element to the calling user. (See Annex M).

NOTE 9: Included in the user-to-network direction when the answering user wants to return user information to the calling user. Included in the network-to-user direction if the user awarded the call included a User-user information element in the CONNECT message. Conditions for this transfer are described in §7.

NOTE 10: The minimum length is 2 octets; the default standard maximum length is 131 octets.

NOTE 11: Included in the network-to-user direction for support of the procedures in Annex D.

NOTE 12: Included by the network e.g. dependent on the telecommunication service requested by the user, or as a subscription option, or as a network provider default option.

3.1.5 Connect acknowledge

This message is sent by the network to the called user to indicate the user has been awarded the call. It may also be sent by the calling user to the network to allow symmetrical call control procedures. See table 3.6.

Table 3.6: Connect acknowledge message content

Message Type: CONNECT ACKNOWLEDGE
Significance: local
Direction: both

Information Element	Reference	Direction	Type	Length
Protocol discriminator	4.2	both	M	1
Call reference	4.3	both	M	2 - 3
Message type	4.4	both	M	1
Channel identification	4.5	n -> u	0 (NOTE 1)	2 - *
Display	4.5	n -> u	0 (NOTE 2)	2 - 34

NOTE 1: Available for use by supplementary services (e.g. call waiting).

NOTE 2: Included if the network provides information that can be presented to the user.

3.1.6 Disconnect

This message is sent by the user to request the network to clear an end-to-end connection or is sent by the network to indicate that the end-to-end connection is cleared. See table 3.7.

Table 3.7: Disconnect message content

Message Type: DISCONNECT
Significance: global
Direction: both

Information Element	Reference	Direction	Type	Length
Protocol discriminator	4.2	both	M	1
Call reference	4.3	both	M	2 - 3
Message type	4.4	both	M	1
Cause	4.5	both	M	4 - 32
Facility	4.6	both	0 (NOTE 1)	2 - *
Progress indicator	4.5	NOTE 2	0 (NOTE 3)	2 - 4
Display	4.5	n -> u	0 (NOTE 4)	2 - 34
User-user	4.5	both	0 (NOTE 7)	NOTE 8

NOTE 1: May be used for functional operation of supplementary services, such as the user-user service, (See §7).

NOTE 2: Included in the network-to-user direction if the network provides in-band tones. See Annex D for usage in the user-to-network direction.

NOTE 3: Included by the network if in-band tones are provided. However, the user may include the Progress Indicator and provide in-band tones (see Annex D). But in this case the network will ignore this information element and will not convey the in-band tones.

NOTE 4: Included if the network provides information that can be presented to the user.

NOTE 5: Spare in ETSI ETS.

NOTE 6: Spare in ETSI ETS.

NOTE 7: Included when the user initiates call clearing and wants to pass user information to the remote user at call clearing time. Conditions for this transfer are described in §7.

NOTE 8: The minimum length is 2 octets; the default standard maximum length is 131 octets.

3.1.7 Facility

ETSI Requirement: This message is defined in ETSI T/S 46-32B.

3.1.8 Information

This message is sent by the user or the network to provide additional information. It may be used to provide information for call establishment (e.g. overlap sending and receiving) or miscellaneous call-related information. See table 3.8

Table 3.8: Information message content

Message Type: INFORMATION
Significance: local (NOTE 1)
Direction: both

Information Element	Reference	Direction	Type	Length
Protocol discriminator	4.2	both	M	1
Call reference	4.3	both	M	2 - 3
Message type	4.4	both	M	1
Sending Complete	4.5	both	0 (NOTE 3)	1
Cause	4.5	n -> u	0 (NOTE 8)	2 - 32
Display	4.5	n -> u	0 (NOTE 4)	2 - 34
Keypad facility	4.5	u -> n (ETSI NOTE)	0 (NOTE 6, 8)	2 - 34
Called party Number	4.5	both	0 (NOTE 9)	2 - 23

NOTE 1: This message has local significance, but may carry information of global significance.

NOTE 2: Spare in ETSI ETS.

NOTE 3: Included if the user optionally indicates completion of overlap sending to the network, or if the network optionally indicates completion of overlap receiving to the user.

NOTE 4: Included if the network provides information that can be presented to the user.

NOTE 5: Spare in ETSI ETS.

NOTE 6: Either The Called party number or the Keypad facility information element is included by the user to convey called party number information to the network during overlap sending. The Keypad facility information element may also be included if the user wants to convey other call establishment information to the network or to convey supplementary service information, (see §7).

NOTE 7: Spare in ETSI ETS.

NOTE 8: As a network option, may be used for stimulus operation of supplementary services, (see §§7 and 8).

NOTE 9: Either The Called party number or the Keypad facility information element is included by the user to convey called party number information to the network during overlap sending. The Called party number information element is included by the network to transfer called party number information to the user during overlap receiving.

ETSI NOTE: The use of the Keypad facility information element in the network-to-user direction to convey supplementary service information as part of the keypad facility procedures is a network option.

3.1.9 Notify

This message is sent by the user or the network to indicate information pertaining to a call, such as user suspended. See table 3.9.

Table 3.9: Notify message content

Message Type: NOTIFY
Significance: access
Direction: both

Information Element	Reference	Direction	Type	Length
Protocol discriminator	4.2	both	M	1
Call reference	4.3	both	M	2 - 3
Message type	4.4	both	M	1
Notification indicator	4.5	both	M	3
Display	4.5	n -> u	0 (NOTE 2)	2 - 34

NOTE 1: Spare in ETSI ETS.

NOTE 2: Included if the network provides information that can be presented to the user.

3.1.10 Progress

This message is sent by the user or the network to indicate the progress of a call in the event of interworking or in relation with the provision of in-band information/patterns. See table 3.10

Table 3.10: Progress message content

Message Type: PROGRESS
Significance: global
Direction: both

Information Element	Reference	Direction	Type	Length
Protocol discriminator	4.2	both	M	1
Call reference	4.3	both	M	2 - 3
Message type	4.4	both	M	1
Cause	4.5	both	0 (NOTE 1)	2 - 32
Progress indicator	4.5	both	M	4
Display	4.5	n -> u	0 (NOTE 2)	2 - 34
User-user	4.5	n -> u	0 (NOTE 4)	NOTE 5

NOTE 1: Included by the user or the network to provide additional information concerning the provision of in-band information/patterns.

NOTE 2: Included if the network provides information that can be presented to the user.

NOTE 3: Spare in ETSI ETS.

NOTE 4: Included when the progress message is sent by the network to indicate that the call has been cleared by the remote user before it reached the Active state, and the remote user wants to pass user information at call clearing time. Conditions for this transfer are described in §7.

NOTE 5: The minimum length is 2 octets; the default standard maximum length is 131 octets.

3.1.11 Release

This message is sent by the user or the network to indicate that the equipment sending the message has disconnected the channel (if any) and intends to release the channel and the call reference, and that the receiving equipment should release the channel and prepare to release the call reference after sending RELEASE COMPLETE message. See table 3.11.

Table 3.11: Release message content

Message Type: RELEASE
Significance: local (NOTE 1)
Direction: both

Information Element	Reference	Direction	Type	Length
Protocol discriminator	4.2	both	M	1
Call reference	4.3	both	M	2 - 3
Message type	4.4	both	M	1
Cause	4.5	both	0 (NOTE 2)	2 - 32
Facility	4.6	both	0 (NOTE 3)	2 - *
Display	4.5	n -> u	0 (NOTE 4)	2 - 34
User-user	4.5	both	0 (NOTE 7)	NOTE 8

NOTE 1: This message has a local significance; however, it may carry information of global significance when used as the first call clearing message.

- NOTE 2: Mandatory in the first call clearing message, including when the RELEASE message is sent as a result of an error handling condition.
- NOTE 3: May be included for functional operation of supplementary services, (see §7).
- NOTE 4: Included if the network provides information that can be presented to the user.
- NOTE 5: Spare in ETSI ETS.
- NOTE 6: Spare in ETSI ETS.
- NOTE 7: Included when the RELEASE message is the first call clearing message, and the user initiates call clearing and wants to pass user information to the remote user at call clearing time. Conditions for this transfer are described in §7.
- NOTE 8: The minimum length is 2 octets; the default standard maximum length is 131 octets.

3.1.12 Release complete

This message is sent by the user or the network to indicate that the equipment sending the message has released the channel (if any) and call reference, the channel is available for reuse, and the receiving equipment shall release the call reference. See table 3.12.

Table 3.12: Release complete message content

Message Type: RELEASE COMPLETE
Significance: local (NOTE 1)
Direction: both

Information Element	Reference	Direction	Type	Length
Protocol discriminator	4.2	both	M	1
Call reference	4.3	both	M	2 - 3
Message type	4.4	both	M	1
Cause	4.5	both	0 (NOTE 2)	2 - 32
Facility	4.6	both	0 (NOTE 3)	2 - *
Display	4.5	n -> u	0 (NOTE 4)	2 - 34
User-user	4.5	u > u	0 (NOTE 7)	NOTE 8

- NOTE 1: This message has a local significance; however, it may carry information of global significance when used as the first call clearing message.
- NOTE 2: Mandatory in the first call clearing message, including when the RELEASE COMPLETE message is sent as a result of an error handling condition.
- NOTE 3: May be used for functional operation of supplementary services, (see §7).
- NOTE 4: Included if the network provides information that can be presented to the user.
- NOTE 5: Spare in ETSI ETS.
- NOTE 6: Spare in ETSI ETS.
- NOTE 7: Included when the RELEASE COMPLETE message is the first call clearing message, and the user initiates call clearing and wants to pass user information to the remote user at call clearing time. Conditions for this transfer are described in §7.

NOTE 8: The minimum length is 2 octets; the standard default maximum length is 131 octets.

3.1.13 Resume

This message is sent by the user to request the network to resume a suspended call. See table 3.13.

Table 3.13: Resume message content

Message Type: RESUME
Significance: local
Direction: user-to-network

Information Element	Reference	Direction	Type	Length
Protocol discriminator	4.2	u -> n	M	1
Call reference	4.3	u -> n	M	2 - 3
Message type	4.4	u -> n	M	1
Call identity	4.5	u -> n	0 (NOTE 1)	2 - 10

NOTE 1: Included when the SUSPEND message used to suspend the call included a Call identity information element.

3.1.14 Resume acknowledge

This message is sent by the network to the user to indicate completion of a request to resume a suspended call. See table 3.14.

Table 3.14: Resume acknowledge message content

Message Type: RESUME ACKNOWLEDGE
Significance: local
Direction: network-to-user

Information Element	Reference	Direction	Type	Length
Protocol discriminator	4.2	n -> u	M	1
Call reference	4.3	n -> u	M	2 - 3
Message type	4.4	n -> u	M	1
Channel identification	4.5	n -> u	M	3 - *
Display	4.5	n -> u	0 (NOTE 1)	2 - 34

NOTE 1: Included if the network provides information that can be presented to the user.

3.1.15 Resume reject

This message is sent by the network to the user to indicate failure of a request to resume a suspended call. See table 3.15.

Table 3.15: Resume reject message content

Message Type: RESUME REJECT
Significance: local
Direction: network-to-user

Information Element	Reference	Direction	Type	Length
Protocol discriminator	4.2	n -> u	M	1
Call reference	4.3	n -> u	M	2 - 3
Message type	4.4	n -> u	M	1
Cause	4.5	n -> u	M	4 - 32
Display	4.5	n -> u	0 (NOTE 1)	2 - 34

NOTE 1: Included if the network provides information that can be presented to the user.

3.1.16 Setup

This message is sent by the calling user to the network and by the network to the called user to initiate call establishment. See table 3.16.

Table 3.16: Setup message content

Message Type: SETUP
Significance: global
Direction: both

Information Element	Reference	Direction	Type	Length
Protocol discriminator	4.2	both	M	1
Call reference	4.3	both	M	2 - 3
Message type	4.4	both	M	1
Sending complete	4.5	both	0 (NOTE 1)	1
Bearer capability	4.5	both	M	4 - 13
Channel identification	4.5	both	0 (NOTE 4)	2 - *
Facility	4.6	both	0 (NOTE 5)	2 - *
Progress indicator	4.5	both	0 (NOTE 6)	2 - 4
Network specific facilities	4.5	both	0 (NOTE 7)	2 - *
Display	4.5	n -> u	0 (NOTE 8)	2 - 34
Keypad facility	4.5	u -> n (ETSI NOTE)	0 (NOTE 9)	2 - 34
Calling party number	4.5	both	0 (NOTE 12)	2 - 24
Calling party subaddress	4.5	both	0 (NOTE 13)	2 - 23
Called party number	4.5	both	0 (NOTE 14)	2 - 23
Called party subaddress	4.5	both	0 (NOTE 15)	2 - 23
Transit network selection	4.5	u -> n	0 (NOTE 16)	2 - *
Low layer compatibility	4.5	both	0 (NOTE 17)	2 - 16
High layer compatibility	4.5	both	0 (NOTE 18)	2 - 4
User-user	4.5	both	0 (NOTE 19)	NOTE 20

NOTE 1: Included if the user or the network optionally indicates that all information necessary for call establishment is included in the SETUP message.

NOTE 2: Spare in ETSI ETS.

NOTE 3: Spare in ETSI ETS.

NOTE 4: Mandatory in the network-to-user direction. Included in the user-to-network direction when the user wants to indicate a channel. If not included, its absence is interpreted as "any channel acceptable".

NOTE 5: May be included for functional operation of supplementary services, (see §7).

NOTE 6: Included in the event of interworking or in connection with the provision of in-band information/patterns.

NOTE 7: Included by the calling user or the network to indicate network specific facilities information (see Annex E).

NOTE 8: Included if the network provides information that can be presented to the user.

NOTE 9: Either The Called party number or the Keypad facility information element is included by the user to convey called party number information to the network. The Keypad facility information element may also be included by the user to convey other call establishment information to the network.

NOTE 10: Spare in ETSI ETS.

NOTE 11: Spare in ETSI ETS.

NOTE 12: May be included by the calling user or the network to identify the calling user.

NOTE 13: Included in the user-to-network direction when the calling user wants to indicate the calling party subaddress. Included in the network-to-user direction if the calling user included a Calling party subaddress information element in the SETUP message.

NOTE 14: Either The Called party number or the Keypad facility information element is included by the user to convey called party number information to the network. The Called party number information element is included by the network when called party number information is conveyed to the user.

NOTE 15: Included in the user-to-network direction when the calling user wants to indicate the Called party subaddress. Included in the network-to-user direction if the calling user included a Called party subaddress information element in the SETUP message.

NOTE 16: Included by the calling user to select a particular transit network (see Annex C).

NOTE 17: Included in the user-to-network direction when the calling user wants to pass low layer compatibility information to the called user. Included in the network-to-user direction if the calling user included a Low layer compatibility information element in the SETUP message.

NOTE 18: Included in the user-to-network direction when the calling user wants to pass high layer compatibility information to the called user. Included in the network-to-user direction if the calling user included a High layer compatibility information element in the SETUP message.

NOTE 19: Included in the user-to-network direction when the calling user wants to pass user information to the called user. Included in the network-to-user direction if the calling user included a User-user information element in the SETUP message. Conditions for this transfer are described in §7.

NOTE 20: The minimum length is 2 octets; the default standard maximum length is 131 octets.

ETSI NOTE: The use of the Keypad facility information element in the network-to-user direction to convey supplementary service information as part of keypad invocation procedure is a network option.

3.1.17 Setup acknowledge

This message is sent by the network to the calling user or by the called user to the network to indicate that call establishment has been initiated, but additional information may be required. See table 3.17.

Table 3.17: Setup acknowledge message content

Message Type: SETUP ACKNOWLEDGE
Significance: local
Direction: both

Information Element	Reference	Direction	Type	Length
Protocol discriminator	4.2	both	M	1
Call reference	4.3	both	M	2 - 3
Message type	4.4	both	M	1
Channel identification	4.5	both	0 (NOTE 1)	2 - *
Progress Indicator	4.5	both	0 (NOTE 2)	2 - 4
Display	4.5	n -> u	0 (NOTE 3)	2 - 34

NOTE 1: Mandatory in all cases, except when the user accepts the specific B-channel indicated in the SETUP message.

NOTE 2: Included in the event of interworking or in connection with the provision of in-band information/patterns.

NOTE 3: Included if the network provides information that can be presented to the user.

3.1.18 Status

This message is sent by the user or the network in response to a STATUS ENQUIRY message or at any time during a call to report certain error conditions listed in §5.8. See table 3.18.

Table 3.18: Status message content

Message Type: STATUS
Significance: local
Direction: both

Information Element	Reference	Direction	Type	Length
Protocol discriminator	4.2	both	M	1
Call reference	4.3	both	M	2 - 3
Message type	4.4	both	M	1
Cause	4.5	both	M	4 - 32
Call State	4.5	both	M	3
Display	4.5	n -> u	0 (NOTE 1)	2 - 34

NOTE 1: Included if the network provides information that can be presented to the user.

3.1.19 Status enquiry

This message is sent by the user or the network at any time to solicit a STATUS message from the peer layer 3 entity. Sending a STATUS message in response to a STATUS ENQUIRY message is mandatory. See table 3.19.

Table 3.19: Status enquiry message content

Message Type: STATUS ENQUIRY
Significance: local
Direction: both

Information Element	Reference	Direction	Type	Length
Protocol discriminator	4.2	both	M	1
Call reference	4.3	both	M	2 - 3
Message type	4.4	both	M	1
Display	4.5"	n -> u	0 (NOTE 1)	2 - 34

NOTE 1: Included if the network provides information that can be presented to the user.

3.1.20 Suspend

This message is sent by the user to request the network to suspend a call. See table 3.20

Table 3.20: Suspend message content

Message Type: SUSPEND
Significance: local
Direction: user-to-network

Information Element	Reference	Direction	Type	Length
Protocol discriminator	4.2	u -> n	M	1
Call reference	4.3	u -> n	M	2 - 3
Message type	4.4	u -> n	M	1
Call identity	4.5	u -> n	0 (NOTE 1)	2 - 10

NOTE 1: Included if the user later wants to identify the suspended call explicitly.

3.1.21 Suspend acknowledge

This message is sent by the network to the user to indicate completion of a request to suspend a call. See table 3.21.

Table 3.21: Suspend acknowledge message content

Message Type: SUSPEND ACKNOWLEDGE
Significance: local
Direction: network-to-user

Information Element	Reference	Direction	Type	Length
Protocol discriminator	4.2	n -> u	M	1
Call reference	4.3	n -> u	M	2 - 3
Message type	4.4	n -> u	M	1
Display	4.5	n -> u	0 (NOTE 1)	2 - 3

NOTE 1: Included if the network provides information that can be presented to the user.

3.1.22 Suspend reject

This message is sent by the network to the user to indicate failure of a request to suspend a call. See table 3.22.

Table 3.22: Suspend reject message content

Message Type: SUSPEND REJECT
Significance: local
Direction: network-to-user

Information Element	Reference	Direction	Type	Length
Protocol discriminator	4.2	n -> u	M	1
Call reference	4.3	n -> u	M	2 - 3
Message type	4.4	n -> u	M	1
Cause	4.5	n -> u	M	4 - 32
Display	4.5	n -> u	0 (NOTE 1)	2 - 34

NOTE 1: Included if the network provides information that can be presented to the user.

3.1.23 User information

This message is sent by the user to the network to transfer information to the remote user. This message is also sent by the network to the user to deliver information from the other user. This message is used if the user- to-user transfer is part of an allowed information transfer as defined in §7.1.4 or 7.1.5. See table 3.23.

Table 3.23: User information message content

Message Type: USER INFORMATION
Significance: access
Direction: both

Information Element	Reference	Direction	Type	Length
Protocol discriminator	4.2	both	M	1
Call reference	4.3	both	M	2 - 3
Message type	4.4	both	M	1
More data	4.5	both	0 (NOTE 1)	1
User-user	4.5	both	M	NOTE 2

NOTE 1: Included by the sending user to indicate that another USER INFORMATION message pertaining to the same message block will follow.

NOTE 2: The minimum length of the User-user information element is 3 octets. The default maximum length is 131 octets; however some networks may only support a maximum length of 35 octets. Procedures for interworking are not currently defined and are for further study.

3.2 Messages for packet mode connection control

ETSI Requirement: The messages for packet-mode access connection control are defined in ETS 300 007.

3.3 Messages for user to user signalling not associated with circuit switched calls

ETSI Requirement: The messages for control of non-call associated temporary signalling connections is outside the scope of this issue of this ETS.

3.4 Messages used with the global call reference

Table 3.50 summarizes the messages which may use the global call reference defined in §4.3

Table 3.50: Messages with the global call reference

Messages	Reference
SEGMENT (ETSI Requirement)	Annex K
RESTART	3.4.1
RESTART ACKNOWLEDGE	3.4.2
STATUS	3.4.3

ETSI Requirement: Not included in CCITT Recommendation Q.931.

3.4.1 Restart

This message is sent by the user or the network to request the recipient to restart (i.e. return to an idle condition) the indicated channel(s) or interface. See table 3.51.

Table 3.51: Restart message content

Message type: RESTART
Significance: local
Direction: both

Information Element	Reference	Direction	Type	Length
Protocol discriminator	4.2	both	M	1
Call reference	4.3	both	M (NOTE 1)	2 - 3
Message type	4.4	both	M	1
Channel identification	4.5	both	0 (NOTE 2)	2 - *
Display	4.5	n -> u	0 (NOTE 3)	2 - 34
Restart indicator	4.5	both	M	3

NOTE 1: This message is sent with the global call reference defined in §4.3.

NOTE 2: Included when necessary to indicate the particular channel(s) to be restarted.

NOTE 3: Included if the network provides the information that can be presented to the user.

3.4.2 Restart acknowledge

This message is sent to acknowledge the receipt of a RESTART message and to indicate that the requested restart is complete. See table 3.52.

Table 3.52: Restart acknowledge message content

Message type: RESTART ACKNOWLEDGE
Significance: local
Direction: both

Information Element	Reference	Direction	Type	Length
Protocol discriminator	4.2	both	M	1
Call reference	4.3	both	M (NOTE 1)	2 - 3
Message type	4.4	both	M	1
Channel identification	4.5	both	0 (NOTE 2)	2 - *
Display	4.5	n -> u	0 (NOTE 3)	2 - 34
Restart indicator	4.5	both	M	3

NOTE 1: This message is sent with the global call reference defined in §4.3.

NOTE 2: Included when necessary to indicate the particular channel(s) which has been restarted.

NOTE 3: Included if the network provides information that can be presented to the user.

3.4.3 Status

This message is sent by the user or the network at any time during a call to report certain error conditions listed in §5.8. See table 3.53.

Table 3.53: Status message content

Message type: STATUS
Significance: local
Direction: both

Information Element	Reference	Direction	Type	Length
Protocol discriminator	4.2	both	M	1
Call reference	4.3	both	M (NOTE 1)	2 - 3
Message type	4.4	both	M	1
Cause	4.5	both	M	4 - 32
Call state	4.5	both	M	3
Display	4.5	n -> u	0 (NOTE 2)	2 - 34

NOTE 1: This message may be sent with the global call reference defined in §4.3

NOTE 2: Included if the network provides information that can be presented to the user.

4 General message format and information elements coding

The figures and text in this section describe message contents. Within each octet, the bit designated "bit 1" is transmitted first, followed by bits 2, 3, 4, etc. Similarly, the octet shown at the top of each figure is sent first.

4.1 Overview

Within this protocol, every message shall consist of the following parts:

- a) protocol discriminator;
- b) call reference;
- c) message type;
- d) other information elements, as required.

Information elements a), b) and c) are common to all the messages and shall always be present, while information elements d) are specific to each message type.

This organization is illustrated in the example shown in figure 4.1.

8	7	6	5	4	3	2	1	Octet
Protocol discriminator								1
0	0	0	0	Length of call reference value (in octets)				2
Call reference value								3
0	Message type							etc.
Other information elements as required								

Figure 4.1: General message organization example

A particular message may contain more information than a particular (user or network) equipment needs or can understand. All equipment should be able to ignore any extra information, present in a message, which is not required for the proper operation of that equipment. For example, a user may ignore the calling party number if that number is of no interest to the user when a SETUP message is received.

Unless specified otherwise, a particular information element may be present only once in a given message.

The term "default" implies that the value defined should be used in the absence of any assignment, or the negotiation of alternative values.

When a field, such as the call reference value, extends over more than one octet, the order of bit values progressively decreases as the octet number increases. The least significant bit of the field is represented by the lowest numbered bit of the highest numbered octet of the field.

4.2 Protocol discriminator

The purpose of the protocol discriminator is to distinguish messages for user-network call control from other messages (to be defined) within this ETS. It also distinguishes messages of this ETS from those OSI network layer protocol units which are coded to other CCITT Recommendations and other standards.

NOTE: A protocol discriminator field is also included in the User-user information element to indicate the user protocol within the user information; however, the coding of the protocol discriminator in this case is shown in §4.5.29.

The protocol discriminator is the first part of every message. The protocol discriminator is coded according to table 4.1.

8	7	6	5	4	3	2	1	Octet
Q.931 (I.451) user-network call control messages								
0	0	0	0	1	0	0	0	1
Protocol discriminator								

Figure 4.2: Protocol discriminator

Table 4.1: Protocol Discriminator

8	7	6	5	4	3	2	1	

0	0	0	0	0	0	0	0	}
								} assigned in §4.5.29; not available
through								} for use in the message protocol discriminator
0	0	0	0	0	1	1	1	}
								} Q.931 user-network call control messages
0	0	0	0	1	0	0	0	}
								} reserved for other network layer or layer 3
through								} protocols, including Recommendation X.25 (Note)
0	0	1	1	1	1	1	1	}
								}
0	1	0	0	0	0	0	0	}
								} national use
through								}
0	1	0	0	0	1	1	1	}
								}
0	1	0	0	1	0	0	0	}
								} reserved for ETSI use
through								}
0	1	0	0	1	1	1	1	}
								}
0	1	0	1	0	0	0	0	}
								} reserved for other network layer or layer 3
through								} protocols, including Recommendation X.25. (Note)
1	1	1	1	1	1	1	0	}

All other values are reserved.

NOTE: These values are reserved to discriminate these protocol discriminators from the first octet of an X.25 packet including general format identifier.

4.3 Call reference

The purpose of the call reference is to identify the call or facility registration/cancellation request at the local user-network interface to which the particular message applies. The call reference does not have end-to-end significance across ISDNs.

The call reference is the second part of every message. The call reference is coded as shown in figure 4.3. The length of the call reference value is indicated in octet 1, bits 1 - 4. The default maximum length of the Call reference information element is three octets long. The actions taken by the receiver are based on the numerical value of the call reference and are independent of the length of the Call reference information element.

At a minimum, All networks and users conforming to this ETS must be able to support a call reference value of one octet for a basic user-network interface, and a call reference value of two octets for a primary rate interface.

As a network option for a primary rate interface, the call reference value may be one octet also. In this case, a call reference value up to 127 may be sent in one or two octets.

ETSI requirement 1: In ISDNs conforming to this ETS the length of the call reference value for the basic access shall be one octet and for the primary rate access two octets.

The call reference information element includes the call reference value and the call reference flag.

Call reference values are assigned by the originating side of the interface for a call. These values are unique to the originating side only within a particular D-Channel layer two logical link connection. The call reference value is assigned at the beginning of a call and remains fixed for the lifetime of a call (except in the case of call suspension). After a call ends, or, after a successful suspension, the associated call reference value may be reassigned to a later call. Two identical call reference values on the same D-Channel layer two logical link connection may be used when each value pertains to a call originated at opposite ends of the link.

The call reference flag can take the values "0" or "1". The call reference flag is used to identify which end of the layer two logical link originated a call reference. The origination side always sets the call reference flag to "0". The destination side always sets the call reference flag to a "1".

Hence the call reference flag identifies who allocated the call reference value for this call and the only purpose of the call reference flag is to resolve simultaneous attempts to allocate the same call reference value. The call reference flag also applies to functions which use the global call reference (e.g. restart procedures).

NOTE 1: The Call reference information element containing a dummy call reference is one octet long and is coded "0000 0000". The use of the dummy call reference is specified in Recommendation Q.932.

ETSI requirement 2: The dummy call reference shall not be used in association with the basic call.

NOTE 2: The numerical value of the global call reference is zero. The equipment receiving a message containing the global call reference should interpret the message as pertaining to all call references associated with the appropriate data link connection identifier. See figure 4.5.

ETSI requirement 3: For the use of the global call reference value see the restart procedure described in §5.5.

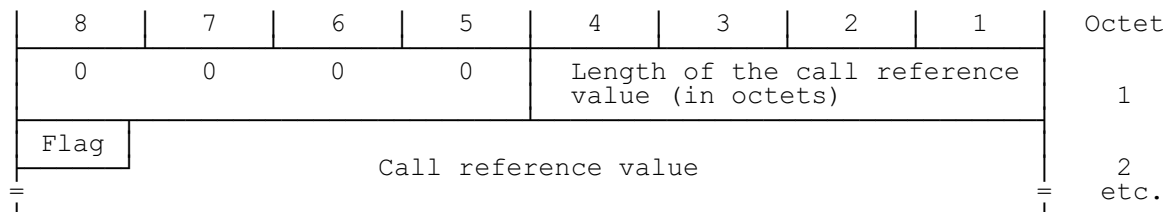

Call reference flag (octet 2)

- bit
- 8
- 0 the message is sent from the side that originates the call reference.
- 1 the message is sent to the side that originates the call reference.

Figure 4.3: Call reference information element

8	7	6	5	4	3	2	1	Octet
0	0	0	0	0	0	0	0	1
				Length of call reference value				

Figure 4.4: Dummy call reference (not applicable in association with the basic call)

8	7	6	5	4	3	2	1	Octet
0	0	0	0	0	0	0	1	1
				Length of call reference value				
0/1 Flag	0	0	0	0	0	0	0	2
Call reference value								

a) One octet call reference value.

8	7	6	5	4	3	2	1	Octet
0	0	0	0	0	0	1	0	1
				Length of call reference value				
0/1 Flag	0	0	0	0	0	0	0	2
Call reference value								
0	0	0	0	0	0	0	0	3

b) Two octet call reference value.

Figure 4.5: Examples of the Encoding for global call reference

4.4 Message type

The purpose of the message type is to identify the function of the message being sent.

The message type is the third part of every message. The message type is coded as shown in figure 4.6 and table 4.2.

Bit 8 is reserved for possible future use as an extension bit.

8	7	6	5	4	3	2	1	Octet
0	Message type							1

Figure 4.6: Message type

Table 4.2: Message types

Bits								
8	7	6	5	4	3	2	1	
0	0	0	0	0	0	0	0	Escape to nationally specific message type; see NOTE: ETSI requirement 1.
0	0	0	-	-	-	-	-	Call establishment messages:
			0	0	0	0	1	ALERTING
			0	0	0	1	0	CALL PROCEEDING
			0	0	1	1	1	CONNECT
			0	1	1	1	1	CONNECT ACKNOWLEDGE
			0	0	0	1	1	PROGRESS
			0	0	1	0	1	SETUP
			0	1	1	0	1	SETUP ACKNOWLEDGE
0	0	1	-	-	-	-	-	Call information phase messages:
			0	0	1	1	0	RESUME
			0	1	1	1	0	RESUME ACKNOWLEDGE
			0	0	0	1	0	RESUME REJECT
			0	0	1	0	1	SUSPEND
			0	1	1	0	1	SUSPEND ACKNOWLEDGE
			0	0	0	0	1	SUSPEND REJECT
			0	0	0	0	0	USER INFORMATION
0	1	0	-	-	-	-	-	Call clearing messages:
			0	0	1	0	1	DISCONNECT
			0	1	1	0	1	RELEASE
			1	1	0	1	0	RELEASE COMPLETE
			0	0	1	1	0	RESTART
			0	1	1	1	0	RESTART ACKNOWLEDGE
0	1	1	-	-	-	-	-	Miscellaneous messages:
			0	0	0	0	0	SEGMENT (ETSI requirement 2)
			1	1	0	0	1	CONGESTION CONTROL
			1	1	0	1	1	INFORMATION
			0	0	0	1	0	FACILITY
			0	1	1	1	0	NOTIFY
			1	1	1	0	1	STATUS
			1	0	1	0	1	STATUS ENQUIRY

NOTE: When used, the message type is defined in the following octet(s), according to the national specification.

ETSI requirement 1: When allocating codes for national message types the following principle shall be applied for the first octet following the escape to nationally specific type.

1	0	X	X	X	X	X	X	National standard
1	1	X	X	X	X	X	X	ETSI standard

ETSI requirement 2: The SEGMENT message is only required if the optional segmentation procedure defined in Annex K is implemented.

4.5 Other information elements

4.5.1 Coding Rules

The coding of other information elements follows the coding rules defined below. These rules are formulated to allow each equipment which processes a message to find information elements important to it, and yet remain ignorant of information elements not important to that equipment.

Two categories of information elements are defined:

- a) single octet information elements (see figure 4.7 a) and b));
- b) variable length information elements (see figure 4.7 c)).

For the information elements listed below, the coding of the information element identifier bits is summarized in table 4.3.

The descriptions of the information elements below are organized in alphabetical order. However, there is a particular order of appearance for each information element in a message within each codeset (see §4.5.2). The code values of the information element identifier for the variable length formats are assigned in ascending numerical order, according to the actual order of appearance of each information element in a message. This allows the receiving equipment to detect the presence or absence of a particular information element without scanning through an entire message.

Single octet information elements may appear at any point in the message. Two types of single octet information elements have been defined. Type 1 elements provide the information element identification in bit positions 7, 6 and 5. The value "0 1 0" in these bit positions is reserved for Type 2 single octet information elements.

Where the description of information elements in this ETS contains spare bits, these bits are indicated as being set to "0". In order to allow compatibility with future implementations, messages should not be rejected simply because a spare bit is set to "1".

The second octet of variable length information element indicates the total length of the contents of that information element regardless of the coding of the first octet (i.e. the length starting with octet 3). It is the binary coding of the number of octets of the contents, with bit 1 as the least significant bit (2^0).

An optional variable length information element may be present, but empty. For example, a SETUP message may contain a Called party number information element, the content of which is of zero length. This should be interpreted by the receiver as equivalent to that information element being absent. Similarly, an absent information element should be interpreted by the receiver as equivalent to that information element being empty.

The following rules apply for the coding of variable length information elements (octet 3, etc):

- a) The first digit in the octet number identifies one octet or a group of octets.
- b) Each octet group is a self contained entity. The internal structure of an octet group may be defined in alternative ways.
- c) An octet group is formed by using some extension mechanism. The preferred extension mechanism is to extend an octet (N) through the next octet(s) (Na, Nb, etc) by using bit 8 in each octet as an extension bit. The bit value "0" indicates that the octet continues through the next octet. The bit value "1" indicates that this octet is the last octet. If one octet (Nb) is present, also the preceding octets (N and Na) must be present.

In the format descriptions appearing in §4.5.5 etc, bit 8 is marked "0/1 ext" if another octet follows. Bit 8 is marked "1 ext" if this is the last octet in the extension domain.

Additional octets may be defined later ("1 ext" changed to "0/1 ext") and equipment shall be prepared to receive such additional octets although the equipment need not be able to interpret or act upon the content of these octets.

- d) In addition to the extension mechanism defined above, an octet (N) may be extended through the next octet(s) (N.1, N.2 etc) by indications in bits 7-1 (of octet N).
- e) The mechanisms in c) and d) may be combined.

f) Optional octets are marked with asterisks (*).

8	7	6	5	4	3	2	1		
1	Information element identifier			Contents of information element					1

a) single octet information element format (type 1)

8	7	6	5	4	3	2	1		
1	Information element identifier								1

b) Single octet information element format (type 2)

8	7	6	5	4	3	2	1		
0	Information element identifier								1
Length of contents of information element (octets)									2
Contents of information element								=	3 etc

c) Variable length information element format

Figure 4.7: Formats of information elements

ETSI NOTE: One of the single octet formats is specified for shift operations described in §4.5.2. This allows for the definition of eight codesets of 133 information element identifier values in each. Codeset 0 is used for these information elements that have been specified in CCITT Recommendation Q.931. Codeset 5 is used for information elements that are specified by ETSI. The following division into two subsections §4.5.1.1 and §4.5.1.2 is particular to the ETSI ETS in order to allow the introduction of §4.5.1.2.

4.5.1.1 Codeset 0

The information elements belonging to codeset 0 are listed in table 4.3, which also gives the coding of the information identifier bits.

Table 4.3: Information element identifier coding

	Section Reference	Maximum Length octets NOTE 1
8 7 6 5 4 3 2 1		
1 : : : - - - -	Single octet information elements:	
0 0 0 - - - -	Reserved	
0 0 1 - - - -	Shift (NOTE 2)	4.5.3/ 4.5.4
0 1 0 0 0 0 0	More data	4.5.19
0 1 0 0 0 0 1	Sending complete	4.5.26
0 1 1 - - - -	Congestion level	4.5.14
1 0 1 - - - -	Repeat Indicator	4.5.23
0 : : : : : :	Variable length information elements:	
0 0 0 0 0 0 0	Segmented message	4.5.25
0 0 0 0 1 0 0	Bearer capability (NOTE 2)	4.5.5
0 0 0 1 0 0 0	Cause (NOTE 2)	4.5.12
0 0 1 0 0 0 0	Call identity	4.5.6
0 0 1 0 1 0 0	Call state	4.5.7
0 0 1 1 0 0 0	Channel identification (NOTE 2)	4.5.13
0 0 1 1 1 0 0	Facility (NOTE 2)	4.6.2
0 0 1 1 1 1 0	Progress indicator (NOTE 2)	4.5.22
0 1 0 0 0 0 0	Network-specific facilities (NOTE 2)	4.5.20
0 1 0 0 1 1 1	Notification indicator	4.5.21
0 1 0 1 0 0 0	Display	4.5.15
0 1 0 1 0 0 1	Date/time	4.6.1
0 1 0 1 1 0 0	Keypad facility	4.5.17
0 1 1 0 1 0 0	Signal (NOTE 2)	4.5.27
0 1 1 0 1 1 0	Switchhook	4.6.5
0 1 1 1 0 0 0	Feature activation	4.6.3
0 1 1 1 0 0 1	Feature indication	4.6.4
1 0 0 0 0 0 0	Information rate	ETS 300 007
1 0 0 0 0 1 0	End-to-end transit delay	ETS 300 007
1 0 0 0 0 1 1	Transit delay selection and indication	ETS 300 007
1 0 0 0 1 0 0	Packet layer binary parameters	ETS 300 007
1 0 0 0 1 0 1	Packet layer window size	ETS 300 007
1 0 0 0 1 1 0	Packet size	ETS 300 007
1 1 0 1 1 0 0	Calling party number	4.5.10
1 1 0 1 1 0 1	Calling party subaddress	4.5.11
1 1 1 0 0 0 0	Called party number	4.5.8
1 1 1 0 0 0 1	Called party subaddress	4.5.9
1 1 1 0 1 0 0	Redirecting number	T/S 46-33R (NOTE 4)
		ETS 300 007
1 1 1 1 0 0 0	Transit network selection (NOTE 2)	4.5.28
1 1 1 1 0 0 1	Restart indicator	4.5.24
1 1 1 1 1 0 0	Low layer compatibility (NOTE 2)	4.5.18
1 1 1 1 1 0 1	High layer compatibility (NOTE 2)	4.5.16
1 1 1 1 1 1 0	User-user	4.5.29
1 1 1 1 1 1 1	Escape for extension (NOTE 3)	35/131
All other values are reserved (NOTE 5)		

NOTE 1: The length limits described for the variable length information elements below take into account only the present CCITT standardized coding values. Future enhancements and expansions to this ETS will not be restricted to these limits.

NOTE 2: This information element may be repeated

NOTE 3: This escape mechanism is limited to codesets 5, 6 and 7 (see §4.5.2). When the escape for extension is used, the information element identifier is contained in octet group 3 and the content of the information element follows in the subsequent octets as shown in figure 4.8

NOTE 4: The maximum length is network dependent

NOTE 5: The reserved values with bits 5-8 coded "0 0 0 0" are for future information elements for which comprehension by the receiver is required (see §5.8.7.1).

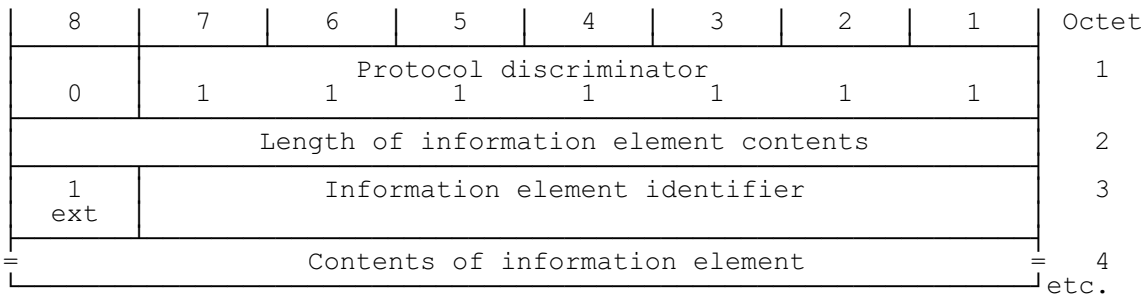

Figure 4.8: Information element format using escape for extension

4.5.1.2 Codeset 5

ETSI requirement 1: The information elements listed in table 4.3 belong to codeset 0. Additionally, table 4.3bis gives the information elements belonging to codeset 5. The rules described above for information elements belonging to codeset 0, shall be applied also for information elements belonging to codeset 5, unless an exception is explicitly stated in relation to the definition of a specific information element.

The relative order of appearance for information elements belonging to different codesets is dependent on the use of the locking or non-locking shift procedures, see §§4.5.3 and 4.5.4 respectively.

Table 4.3bis: Codeset 5 information element identifier coding

	Section Reference
8 7 6 5 4 3 2 1	
1 : : : - - - - Single octet information elements:	
0 0 0 - - - - reserved	
0 0 1 - - - - Shift (ETSI requirement 2)	4.5.3/ 4.5.4
0 : : : : : : : Variable length information elements:	
0 0 1 1 0 1 0 reserved (ETSI requirement 3)	

ETSI requirement 2: This information element may be repeated.

ETSI requirement 3: Reserved in order to preserve backward compatibility with earlier versions of this ETS.

4.5.2 Extensions of codesets

There is a certain number of possible information element identifier values using the formatting rules described in §4.5.1; 128 from the variable length information element format and at least 8 from the single octet information element format.

One value in the single octet format is specified for shift operations described below. One other value in both the single octet and variable format is reserved. This leaves at least 133 information element identifier values available for assignment.

It is possible to expand this structure to eight codesets of at least 133 information element identifier values each. One common value in the single octet format is employed in each codeset to facilitate shifting from one codeset to another. The contents of this Shift information element identifies the codeset to be used for the next information element or elements. The codeset in use at any given time is referred to as the "active codeset". By convention, codeset 0 is the initially active codeset.

Two codeset shifting procedures are supported: locking shift and non-locking shift.

Codeset 5 is reserved for information elements reserved for national use defined by ETSI.

Codeset 6 is reserved for information elements specific to the local a national network (either public or private).

Codeset 7 is reserved for user-specific information elements.

The coding rules specified in §4.5.1 shall apply for information elements belonging to any active codeset.

Transitions from one active codeset to another (i.e. by means of the locking shift procedure) may only be made to a codeset with a higher numerical value than the codeset being left.

An information element belonging to codesets 5, 6 or 7, may appear together with information elements belonging to codeset 0 (being the active codeset) by using the non-locking shift procedure (see §4.5.4).

A user of network equipment shall have the capability to recognize a Shift information element and to determine the length of the following information element, although the equipment need not be able to interpret and act upon the content of the information element. This enables the equipment to determine the start of a subsequent information element.

Codeset 7 information elements shall be handled according to the procedures for unrecognized information elements (see §5.8.7.1) by the first exchange in the local network, unless allowed by a future service definition, bilateral agreement, or provision is made to support this across the local network for a specific user.

Codeset 6 is reserved for information elements specific to the local a national network (either public or private). As such they do not have significance across the boundaries between local networks, or across a national, or international boundary. Therefore, codeset 6 information elements shall be handled according to the procedures for unrecognized information elements (see §5.8.7.1) beyond local network boundary, unless allowed by bilateral agreement.

Codeset 5 is reserved for information elements reserved for national use defined by ETSI. As such they do not have significance across an international boundary. Therefore, codeset 5 information elements shall be handled according to the procedures for unrecognized information elements (see §5.8.7.1) at the first exchange beyond the international boundary, unless there are bilateral agreements to the contrary. Therefore, codeset 5 information elements shall be handled according to the procedures defined for codeset 0.

ETSI requirement: The information element identifier code points with bits 5 to 8 coded "0 0 0 0" in each of the codesets are reserved for information elements for which comprehension by the receiver is required (see §5.8.7.1 for specific error handling procedures).

4.5.3 Locking shift procedure

The locking shift procedure employs an information element to indicate the new active codeset. The specified codeset remains active until another locking shift information element is encountered which specifies the use of another codeset. For example, codeset 0 is active at the start of message content analysis. If a locking shift to codeset 5 is encountered, the next information elements will be interpreted according to the information element identifiers assigned in codeset 5, until another shift information element is encountered.

This procedure is used only to shift to a higher order codeset than the one being left.

The locking shift is valid only within that message which contains the locking Shift information element. At the start of every message content analysis, the active codeset is codeset 0.

The locking Shift information element uses the single octet information element format and coding shown in figure 4.9 and table 4.4.

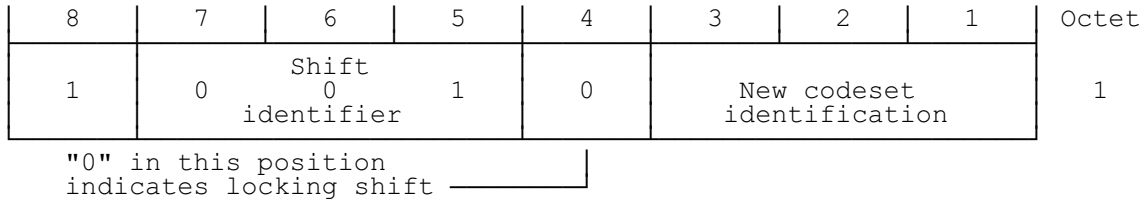

Figure 4.9: Locking Shift information element

Table 4.4: Locking Shift element information element

Codeset identification (bits 3 to 1):

3 2 1

0 0 0 not applicable

0 0 1 }
to } reserved
1 0 0 }

1 0 1 codeset 5: information elements for national use defined by ETSI

1 1 0 codeset 6: information elements specific to the local a national network (either public or private)

1 1 1 codeset 7: user specific information elements

4.5.4 Non-locking shift procedure

The non-locking shift procedure provides a temporary shift to the specified lower or higher codeset. The non-locking shift procedure uses a single octet information element to indicate the codeset to be used to interpret the next single information element. After the interpretation of the next single information element, the active codeset is again used for interpreting any following information elements. For example, codeset 0 is active at the beginning of message content analysis. If a non-locking shift to codeset 6 is encountered, only the next information element is interpreted according to the information element identifiers assigned in codeset 6. After this information element is interpreted, codeset 0 will again be used to interpret the following information elements. A non-locking Shift information element indicating the current codeset shall not be regarded as an error.

A locking Shift information element shall not follow directly a non-locking Shift information element. If this combination is received it shall be interpreted as though a locking Shift information element only had been received.

The non-locking Shift information element uses the single octet information element format and coding shown in figure 4.10 and table 4.5.

8	7	6	5	4	3	2	1	Octet
1	0	0	1	1	Temporary codeset identification			1

"1" in this position indicates non-locking shift

Figure 4.10: Non-locking Shift information element

Table 4.5: Non-locking Shift information element

Codeset identification (bits 3 to 1):

3 2 1	
0 0 0	codeset 0 (initially active): Q.931 information elements
0 0 1 }	
to }	reserved
1 0 0 }	
1 0 1	codeset 5: information elements for national use defined by ETSI
1 1 0	codeset 6: information elements specific to the local a national network (either public or private)
1 1 1	codeset 7: user-specific information elements

4.5.5 Bearer capability

The purpose of the bearer capability information element is to indicate a requested CCITT Recommendation I.231 bearer service to be provided by the network. It contains only information which may be used by the network, (see Annex L). The use of the Bearer capability information element in relation to compatibility checking is described in Annex B.

The Bearer capability information element is coded as shown in figure 4.11 and table 4.6.

Examples of the coding of the Bearer capability information element are shown in Annex H.

No default bearer capability may be assumed by the absence of this information element.

The maximum length of this information element is 13 octets when CCITT standard coding is used.

NOTE: Future extensions to the codings of the Bearer capability information element should not be in conflict with the currently defined coding of the Low layer compatibility information element (see §4.5.18).

8	7	6	5	4	3	2	1	Octet
0	0	0	0	0	1	0	0	1
Bearer capability Information element identifier								
Length of the bearer capability contents								2
1 ext	coding standard	information transfer capability						3
0/1 ext	transfer mode	information transfer rate						4
0/1 ext	structure			configuration		establishment		4a* (NOTE 1)
1 ext	symmetry		information transfer rate (destination -> origination)					4b* (NOTE 1)
0/1 ext	0	1	user information layer 1 protocol					5*
0/1 ext	synch./ asynch.	negot.	user rate					5a* (NOTE 4)
0/1 ext	intermediate rate		NIC on Tx	NIC on Rx	Flow control on Tx	Flow control on Rx	0 Spare	5b* (NOTE 2)
0/1 ext	Hdr/ no Hdr	Multi frame support	Mode	LLI negot.	Assign- nor/As- signee	Inband/ Outband negot.	0 Spare	5b* (NOTE 3)
0/1 ext	number of stop bits		number of data bits		Parity			5c* (NOTE 4)
1 ext	duplex mode	modem type						5d* (NOTE 4)
1 ext	1	0	user information layer 2 protocol					6*
1 ext	1	0	user information layer 3 protocol					7*

Figure 4.11: Bearer capability information element

NOTE 1: If default values are used for all fields of octets 4a and 4b, then these octets shall not be included. If default values are used for all fields of octet 4b, but not for one or more fields of octet 4a, then only octet 4a shall be included. Otherwise, both octets 4a and 4b shall be included.

NOTE 2: This octet may be present only if octet 5 indicates CCITT standardized rate adaption V.110/X.30.

NOTE 3: This octet is present only if octet 5 indicates CCITT standardized rate adaption V.120.

NOTE 4: This octet may be present if octet 5 indicates either of the CCITT standardized rate adaptions V.110/X.30 or V.120

Table 4.6 (1 of 7): Bearer capability information element

Coding Standard (octet 3)

Bits

7 6

0 0 CCITT standardized coding as described below (ETSI NOTE)
0 1 reserved for other international standards (NOTE)
1 0 national standard (NOTE)
1 1 standard defined for the network (either public or private) present on the network side of the interface (NOTE).

NOTE: These other coding standards should be used only when the desired bearer capability can not be represented with the CCITT standardized coding.

ETSI NOTE: In ISDNs conforming to this ETS, codepoint "0 0" "CCITT standardized coding as described below" shall always be used.

Information transfer capability (octet 3)

Bits

5 4 3 2 1

0 0 0 0 0 speech
0 1 0 0 0 unrestricted digital information
0 1 0 0 1 restricted digital information (ETSI NOTE)
1 0 0 0 0 3.1 kHz audio
1 0 0 0 1 7 kHz audio
1 1 0 0 0 video

All other values are reserved.

ETSI NOTE: Not applicable in ISDNs conforming to this ETS.

Transfer mode (octet 4)

Bits

7 6

0 0 Circuit mode
1 0 packet mode

All other values are reserved.

Information transfer rate (octet 4 and 4b, bits 5 to 1)

Bits

5 4 3 2 1

	Circuit mode	Packet mode
0 0 0 0 0		- This code shall be used for packet-mode calls
1 0 0 0 0	64 kbit/s	-
1 0 0 0 1	2 x 64 kbit/s	-
1 0 0 1 1	384 kbit/s	-
1 0 1 0 1	1536 kbit/s	-
1 0 1 1 1	1920 kbit/s	-

All other values are reserved.

NOTE 1: When octet 4b is omitted, the bearer capability is bi-directional symmetric at the information transfer rate specified in octet 4. When octet 4b is included, the information transfer rate in octet 4 refers to the origination → destination direction.

NOTE 2: When the information transfer rate 2 x 64 kbit/s is used the coding of octet 3 and 4 refer to both 64 kbit/s channels

Table 4.6 (2 of 7): Bearer capability information element

Structure (octet 4a)

Bits	
<u>7 6 5</u>	
0 0 0	default (see NOTE 1)
0 0 1	8 kHz integrity (see NOTE 2)
1 0 0	service data unit integrity
1 1 1	unstructured

All other values are reserved.

NOTE 1: If octet 4a is omitted, or the structure field is coded "000", then the value of the structure attribute is according to the following:

Transfer mode	Transfer capability	Structure
circuit	speech	8 kHz integrity
circuit	unrestricted digital	8 kHz integrity
circuit	restricted digital	8 kHz integrity (ETSI NOTE)
circuit	audio	8 kHz integrity
circuit	video	8 kHz integrity
packet	unrestricted digital	service data unit integrity

NOTE 2: When the information transfer rate 2 x 64 kbit/s is used, 8 kHz integrity with Restricted Differential Time Delay (RDTD) is offered.

ETSI NOTE: Not applicable in ISDNs conforming to this ETS.

Configuration (octet 4a)

Bits	
<u>4 3</u>	
0 0	point-to-point

All other values are reserved.

NOTE: If octet 4a is omitted, the configuration is assumed to be point-to-point.

Establishment (octet 4a)

Bits	
<u>2 1</u>	
0 0	demand

All other values are reserved.

NOTE: If octet 4a is omitted, the method of establishment is assumed to be "demand".

Symmetry (octet 4b)

Bits	
<u>7 6</u>	
0 0	bi-directional symmetric

All other values are reserved.

NOTE: If octet 4b is omitted, bi-directional symmetric is assumed.

Table 4.6 (3 of 7): Bearer capability information element

User information layer 1 protocol (octet 5)

Bits

5 4 3 2 1

0 0 0 0 1

CCITT standardized rate adaption V.110/X.30. This implies the presence of octet 5a and optionally octet 5b, 5c and 5d as defined below.

0 0 0 1 0

Recommendation G.711 μ -law (ETSI NOTE)

0 0 0 1 1

Recommendation G.711 A-law

0 0 1 0 0

Recommendation G.721 32kbit/s ADPCM and Recommendation I.460

0 0 1 0 1

Recommendation G.722 and G.725 7 kHz audio

0 0 1 1 0

Recommendation G.7xx 384 kbit/s video

0 0 1 1 1

Non-CCITT standardized rate adaption. This implies the presence of octet 5a and optionally, octets 5b, 5c and 5d. The use of this codepoint indicates that the user rate specified in octet 5a is defined in accordance with the non-CCITT standardized rate adaption scheme. Additionally, octets 5b, 5c and 5d, if present, are defined consistent with the specified rate adaption.

0 1 0 0 0

CCITT standardized rate adaption V.120. This implies the presence of octets 5a and 5b as defined below and optionally octets 5c and 5d. (ETSI NOTE).

0 1 0 0 1

CCITT standardized rate adaption X.31 HDLC flag stuffing.

All other values are reserved.

NOTE: If the transfer mode is "circuit mode"; and if the information transfer capability is "unrestricted digital information" or "restricted digital information"; and if the user information layer 1 protocol is not to be identified to the network, octet 5 shall be omitted. If the transfer mode is packet mode, octet 5 may be omitted. Otherwise, octet 5 shall be present.

ETSI NOTE: Not applicable in ISDNs conforming to this ETS.

Synchronous/asynchronous (octet 5a)

Bit

7

0 synchronous

1 asynchronous

NOTE: Octets 5b, 5c and 5d may be omitted in case of synchronous user rates.

Negotiation (octet 5a)

Bit

6

0 in-band negotiation not possible

1 in-band negotiation possible

NOTE: See Recommendations V.110 and X.30.

Table 4.6 (4 of 7): Bearer capability information element

User rate (octet 5a)

Bits			
5	4 3 2 1		
0	0 0 0 0	rate is indicated by E-bits specified in Recommendation I.460	
0	0 0 0 1	0.6 kbit/s	Recommendation V.6 and X.1
0	0 0 1 0	1.2 kbit/s	Recommendation V.6
0	0 0 1 1	2.4 kbit/s	Recommendation V.6 and X.1
0	0 1 0 0	3.6 kbit/s	Recommendation V.6
0	0 1 0 1	4.8 kbit/s	Recommendation V.6 and X.1
0	0 1 1 0	7.2 kbit/s	Recommendation V.6
0	0 1 1 1	8 kbit/s	Recommendation I.460
0	1 0 0 0	9.6 kbit/s	Recommendation V.6 and X.1
0	1 0 0 1	14.4 kbit/s	Recommendation V.6
0	1 0 1 0	16 kbit/s	Recommendation I.420
0	1 0 1 1	19.2 kbit/s	Recommendation V.6
0	1 1 0 0	32 kbit/s	Recommendation I.460
0	1 1 1 0	48 kbit/s	Recommendation V.6 and X.1
0	1 1 1 1	56 kbit/s	Recommendation V.6
1	0 0 0 0	64 kbit/s	Recommendation X.1
1	0 1 0 1	0.1345 kbit/s	Recommendation X.1
1	0 1 1 0	0.100 kbit/s	Recommendation X.1
1	0 1 1 1	0.075/1.2 kbit/s	Recommendation V.6 and X.1 (NOTE)
1	1 0 0 0	1.2/0.075 kbit/s	Recommendation V.6 and X.1 (NOTE)
1	1 0 0 1	0.050 kbit/s	Recommendation V.6 and X.1
1	1 0 1 0	0.075 kbit/s	Recommendation V.6 and X.1
1	1 0 1 1	0.110 kbit/s	Recommendation V.6 and X.1
1	1 1 0 0	0.150 kbit/s	Recommendation V.6 and X.1
1	1 1 0 1	0.200 kbit/s	Recommendation V.6 and X.1
1	1 1 1 0	0.300 kbit/s	Recommendation V.6 and X.1
1	1 1 1 1	12 kbit/s	Recommendation V.6

All other values are reserved.

NOTE: The first rate is the transmit rate in the forward direction of the call. The second rate is the transmit rate in the backward direction of the call.

* Octet 5b for V.110/X.30 rate adaption *

Intermediate rate (octet 5b)

Bits		
7	6	
0	0	not used
0	1	8 kbit/s
1	0	16 kbit/s
1	1	32 kbit/s

Network Independent Clock (NIC) on Transmission (Tx) (octet 5b) (NOTE 1)

Bit	
5	
0	not required to send data with Network Independent Clock
1	required to send data with Network Independent Clock

NOTE 1: Refers to transmission in the backward direction of the call

NOTE 2: See Recommendations V.110 and X.30.

Table 4.6 (5 of 7): Bearer capability information element

Network Independent Clock (NIC) on reception (Rx) (octet 5b) (NOTE 1)

Bits

- 4
- 0 cannot accept data with Network Independent Clock (i.e. sender does not support this optional procedure)
- 1 can accept data with Network Independent Clock (i.e. sender does support this optional procedure)

NOTE 1: Refers to transmission in the forward direction of the call.

NOTE 2: See Recommendations V.110 and X.30.

Flow control on transmission (Tx) (octet 5b) (NOTE 1)

Bit

- 3
- 0 not required to send data with flow control mechanism
- 1 required to send data with flow control mechanism

NOTE 1: Refers to transmission in the forward direction of the call.

NOTE 2: See Recommendations V.110 and X.30.

Flow control on reception (Rx) (octet 5b) (NOTE 1)

Bit

- 2
- 0 cannot accept data with flow control mechanism (i.e. sender does not support this optional procedure).
- 1 can accept data with flow control mechanism (i.e. sender does support this optional procedure).

NOTE 1: Refers to transmission in the backward direction of the call.

NOTE 2: See Recommendations V.110 and X.30.

* Octet 5b for V.120 rate adaption *

ETSI NOTE: This coding option for octet 5b is not applicable in ISDNs conforming to this ETS.

Rate adaption header/no header (octet 5b)

Bit

- 7
- 0 rate adaption header not included
- 1 rate adaption header included

Multiple frame establishment support in data link (octet 5b)

Bit

- 6
- 0 multiple frame establishment not supported. Only UI frames allowed
- 1 multiple frame establishment supported

Mode of operation (octet 5b)

Bit

- 5
- 0 bit transparent mode of operation
- 1 protocol sensitive mode of operation

Table 4.6 (6 of 7): Bearer capability information element

Logical link identifier negotiation (octet 5b)

Bit	
4	
0	default, LLI = 256 only
1	full protocol negotiation (NOTE)

NOTE: A connection over which protocol negotiation will be executed is indicated in bit 2 of octet 5b.

Assignor/assignee (octet 5b)

Bit	
3	
0	message originator is "Default assignee"
1	message originator is "Assignor only"

In-band/Out-band negotiation (octet 5b)

Bit	
2	
0	negotiation is done with USER INFORMATION messages on a temporary signalling connection
1	negotiation is done in-band using logical link zero.

Number of stop bits (octet 5c)

Bits	
7 6	
0 0	not used
0 1	1 bit
1 0	1.5 bits
1 1	2 bits

Number of data bits excluding parity bit if present (octet 5c)

Bits	
5 4	
0 0	not used
0 1	5 bits
1 0	7 bits
1 1	8 bits

Parity information (octet 5c)

Bits	
3 2 1	
0 0 0	odd
0 1 0	even
0 1 1	none
1 0 0	forced to 0
1 0 1	forced to 1
All other values reserved.	

Table 4.6 (7 of 7): Bearer capability information element

Duplex mode (octet 5d)

Bit	
7	
0	half duplex
1	full duplex

Modem type (octet 5d)

Bits	
6 5 4 3 2 1	
0 0 0 0 0 0	Reserved
0 0 0 0 0 1	V.21
0 0 0 0 1 0	V.22
0 0 0 0 1 1	V.22 bis
0 0 0 1 0 0	V.23
0 0 0 1 0 1	V.26
0 0 0 1 1 0	V.26 bis
0 0 0 1 1 1	V.26 ter
0 0 1 0 0 0	V.27
0 0 1 0 0 1	V.27 bis
0 0 1 0 1 0	V.27 ter
0 0 1 0 1 1	V.29
0 0 1 1 0 0	V.32
0 0 1 1 0 1	V.35
1 0 0 0 0 0 }	
through }	Reserved for national use
1 1 1 1 1 1 }	

All other values reserved.

User information layer 2 protocol (octet 6)

Bits	
5 4 3 2 1	
0 0 0 1 0	Recommendation Q.921 (I.441)
0 0 1 1 0	Recommendation X.25, link level

All other values are reserved.

NOTE: If the transfer mode is "packet mode", octet 6 shall be present. For other cases, if the user layer 2 protocol is to be identified to the network, then octet 6 shall be present; otherwise octet 6 shall be omitted.

User information layer 3 protocol (octet 7)

Bits	
5 4 3 2 1	
0 0 0 1 0	Recommendation Q.931 (I.451)
0 0 1 1 0	Recommendation X.25, packet layer

All other values are reserved.

NOTE: If the user information layer 3 protocol is to be identified to the network, then octet 7 shall be present; otherwise octet 7 shall be omitted

4.5.6 Call Identity

The purpose of the Call identity information element is to identify the suspended call. The call identity provided by the user is guaranteed by the network to be unique over the user-network interface on which

the user resides. The call identity is assigned at the start of the call suspension, and is available for re-use after the resume procedure has been completed successfully.

The Call identity information element is coded as shown in figure 4.12.

The default maximum length of this information element is 10 octets.

8	7	6	5	4	3	2	1	Octet
0	0	0	1	0	0	0	0	1
Call Identity Information element identifier								
Length of the call identify contents								2
Call identity (any bit pattern allowed, e.g. IA5 characters)								3

Figure 4.12: Call identity information element

4.5.7 Call State

The purpose of the Call state information element is to describe the current status of a call, (see §2.1) or an access connection (see §2.2) or a global interface state (see §2.4).

The Call state information element is coded as shown in figure 4.13 and table 4.7.

The maximum length of this information element is three octets when CCITT standard coding is used.

8	7	6	5	4	3	2	1	Octet
0	0	0	1	0	1	0	0	1
Call State Information element identifier								
Length of the call state contents								2
coding standard	Call state value/global interface state value (state value is coded in binary)							3

Figure 4.13: Call state information element

Table 4.7: Call state information element

Coding standard (octet 3)

Bits	
8 7	
0 0	CCITT standardized coding, as described below
0 1	reserved for other international standards (NOTE)
1 0	national standard (NOTE)
1 1	standard defined for the network (either public or private) present on the network side of the interface (NOTE)

NOTE: These other coding standards should be used only when the desired call state cannot be represented with the CCITT standardized coding.

Call state value (octet 3)

Bits		
6 5 4 3 2 1	User State	Network state
0 0 0 0 0 0	U0 - Null	N0 - Null
0 0 0 0 0 1	U1 - Call Initiated	N1 - Call Initiated
0 0 0 0 1 0	U2 - Overlap sending	N2 - Overlap sending
0 0 0 0 1 1	U3 - Outgoing call Proceeding	N3 - Outgoing call Proceeding
0 0 0 1 0 0	U4 - Call Delivered	N4 - Call Delivered
0 0 0 1 1 0	U6 - Call Present	N6 - Call Present
0 0 0 1 1 1	U7 - Call Received	N7 - Call Received
0 0 1 0 0 0	U8 - Connect Request	N8 - Connect Request
0 0 1 0 0 1	U9 - Incoming Call Proceeding	N9 - Incoming Call Proceeding
0 0 1 0 1 0	U10 - Active	N10 - Active
0 0 1 0 1 1	U11 - Disconnect Request	N11 - Disconnect Request
0 0 1 1 0 0	U12 - Disconnect Indication	N12 - Disconnect Indication
0 0 1 1 1 1	U15 - Suspend Request	N15 - Suspend Request
0 1 0 0 0 1	U17 - Resume Request	N17 - Resume Request
0 1 0 0 1 1	U19 - Release Request	N19 - Release Request
0 1 0 1 1 0		N22 - Call Abort
0 1 1 0 0 1	U25 - Overlap Receiving	N25 - Overlap Receiving
All other values are reserved.		

Global interface state value (octet 3)

Bits	
6 5 4 3 2 1	State
0 0 0 0 0 0	REST 0 - Null
1 1 1 1 0 1	REST 1 - Restart Request
1 1 1 1 1 0	REST 2 - Restart
All other values are reserved.	

4.5.8 Called party number

The purpose of the Called party number information element is to identify the called party of a call.

The Called party number information element is coded as shown in figure 4.14 and table 4.8.

The maximum length of this information element is network dependent 23 octets.

8	7	6	5	4	3	2	1	Octet
0	Called party number Information element identifier							1
Length of called party number contents								2
1 ext	Type of number			Numbering plan identification				3
0	Number digits (IA5 characters, see NOTE)							4 etc

NOTE: The number digits appear in multiple octets 4's, in the same order in which they would be entered, that is, the number digit which would be entered first is located in the first octet 4.

Figure 4.14: Called party number information element

Table 4.8: Called party number information element

Type of number (octet 3) (NOTE 1)

Bits	
7	6 5
0 0 0	unknown (note 2)
0 0 1	international number (NOTE 3)
0 1 0	national number (NOTE 3)
0 1 1	network specific number (NOTE 4)
1 0 0	subscriber number (NOTE 3)
1 1 0	abbreviated number (NOTE 5)
1 1 1	reserved for extension

All other values are reserved.

NOTE 1: For the definition of international, national and subscriber number, see CCITT Recommendation I.330.

NOTE 2: The type of number "unknown" is used when the user or the network has no knowledge of the type of number, e.g. international number, national number, etc. In this case the number digits field is organized according to the network dialling plan; e.g. prefix or escape digits might be present.

NOTE 3: Prefix or escape digits shall not be included.

NOTE 4: The type of number "network specific number" is used to indicate administration/service number specific to the serving network, e.g. used to access an operator.

NOTE 5: The support of this code is network dependent. The number provided in this information element presents a shorthand representation of the complete number in the specified numbering plan as supported by the network.

Numbering plan identification (octet 3)

Numbering plan (applies for type of number = 000, 001, 010 and 100)

Bits	
4	3 2 1
0 0 0 0	unknown (NOTE)
0 0 0 1	ISDN/Telephony numbering plan (CCITT Recommendation E.164/E.163)
0 0 1 1	data numbering plan (CCITT Recommendation X.121)
0 1 0 0	telex numbering plan (CCITT Recommendation F.69)
1 0 0 0	national standard numbering plan
1 0 0 1	private numbering plan
1 1 1 1	reserved for extension

All other values are reserved.

NOTE: The numbering plan "unknown" is used when the user or the network has no knowledge of the numbering plan. In this case the number digits field is organized according to the network dialling plan; e.g. prefix or escape digits might be present.

Number digits (octets 4 etc.)

This field is coded with IA5 characters, according to the formats specified in the appropriate numbering/dialling plan.

4.5.9 Called party subaddress

The purpose of the Called party subaddress is to identify the subaddress of the called party of a call. For the definition of subaddress see CCITT Recommendation I.330.

The Called party subaddress is coded as shown in figure 4.15 and table 4.9.

The maximum length of this information element is 23 octets.

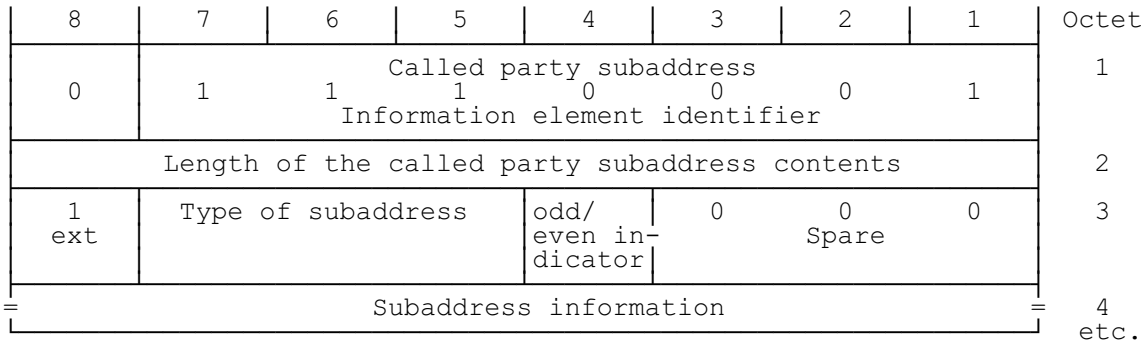

Figure 4.15: Called party subaddress information element

Table 4.9: Called party subaddress information element

Type of subaddress (octet 3)

Bits
7 6 5
0 0 0 NSAP (X.213/ISO 8348 AD2)
0 1 0 user specified
All other values are reserved.

Odd/even indicator (octet 3)

Bit
4
0 even number or address signals
1 odd number or address signals

NOTE: The odd/even indicator is used when the type of subaddress is "user specified" and the coding is BCD.

Subaddress information (octet 4, etc)

The NSAP X.213/ISO 8348 AD2 address, shall be formatted as specified by octet 4 which contains the Authority and Format Identifier (AFI). The encoding is made according to the "preferred binary encoding" as defined in X.213/ISO 8348 AD2. For the definition of this type of subaddress, see CCITT Recommendation I.334. Coding examples are given in Annex H.

For user specified subaddress, this field is encoded according to the user specification, subject to a maximum length of 20 octets. When interworking with X.25 networks BCD coding should be applied.

NOTE 1: It is recommended that users apply the NSAP subaddress type since this subaddress type allows the use of decimal, binary and IA5 syntaxes in a standardized manner.

NOTE 2: When the Initial Domain Identifier (IDI) format is "local", the AFI field is coded "50" in BCD. IA5/ISO646 character syntax DSP is then represented by converting each character to a number in the range 32-127 using the T.50/ISO646 encoding, with zero parity and the parity bit in the most significant position, yielding a binary octet in the range 0010 0000 - 0111 1111.

NOTE 3: It is recommended that users apply the local IDI format when the subaddress is used for terminal selection purposes. In this case the IA5 character syntax using only digits 0 to 9 shall be used for the DSP.

4.5.10 Calling Party Number

The purpose of the Calling party number information element is to identify the origin of a call.

The Calling party number information element is coded as shown in figure 4.16 and table 4.10. The maximum length of this information element is network dependent 24 octets.

8	7	6	5	4	3	2	1	Octet	
0	1	1	0	1	1	0	0	1	
Calling party number Information element identifier									
Length of calling party number contents								2	
0/1 ext	Type of number			Numbering plan identification				3	
1 ext	Presentation indicator	0	0	0	Spare			Screening indicator	3a
0	Number digits (IA5 characters)							4	
								etc	

Figure 4.16: Calling party number information element

Table 4.10 (1 of 2): Calling party number information element

Type of number (octet 3) (NOTE 1)

Bits	
7 6 5	
0 0 0	unknown (NOTE 2)
0 0 1	international number (NOTE 3)
0 1 0	national number (NOTE 3)
0 1 1	network specific number (NOTE 4)
1 0 0	subscriber number (NOTE 3)
1 1 0	abbreviated number (NOTE 5)
1 1 1	reserved for extension

All other values are reserved.

NOTE 1: For the definition of international, national, and subscriber number, see CCITT Recommendation I.330.

NOTE 2: The type of number "unknown" is used when the user or the network has no knowledge of the type of number, e.g. international number, national number, etc. In this case the number digits field is organized according to the network dialling plan; e.g. prefix or escape digits might be present.

NOTE 3: Prefix or escape digits shall not be included.

NOTE 4: The type of number "network specific number" is used to indicate administration/service number specific to the serving network, e.g. used to access an operator.

NOTE 5: This code point is not applicable to this ETS.

Table 4.10 (2 of 2): Calling party number information element

Numbering plan identification (octet 3)

Numbering plan (applies for type of number = 000, 001, 010 and 100)

Bits

4 3 2 1

0 0 0 0	unknown (NOTE)
0 0 0 1	ISDN/Telephony numbering plan (CCITT Rec. E.164/E.163)
0 0 1 1	data numbering plan (CCITT Rec. X.121)
0 1 0 0	telex numbering plan (CCITT Rec. F.69)
1 0 0 0	national standard numbering plan
1 0 0 1	private numbering plan
1 1 1 1	reserved for extension

All other values are reserved.

NOTE: The numbering plan "unknown" is used when the user or the network has no knowledge of the numbering plan. In this case the number digits field is organized according to the network dialling plan; e.g. prefix or escape digits might be present.

Presentation indicator (octet 3a)

Bits

7 6

0 0	presentation allowed
0 1	presentation restricted
1 0	number not available due to interworking
1 1	reserved

NOTE: At the originating user-network interface, the presentation indicator is used for indicating the intention of the calling user for the presentation of the calling party number to the called user. This may also be requested on a subscription basis. If octet 3a is omitted, and the network does not support subscription information for the calling party number information restrictions, the value "00 - presentation allowed" is assumed.

Screening indicator (octet 3a)

Bits

2 1

0 0	user-provided, not screened
0 1	user-provided, verified and passed
1 0	user-provided, verified and failed (ETSI NOTE)
1 1	network provided

NOTE: If octet 3a is omitted, "00 - user-provided not screened" is assumed.

ETSI NOTE: Not applicable in ISDNs conforming to this ETS.

Number digits (octets 4, etc)

This field is coded with IA5 characters, according to the formats specified in the appropriate numbering/dialling plan.

4.5.11 Calling party subaddress

The purpose of the Calling party subaddress information element is to identify a subaddress associated with the origin of a call. For the definition of subaddress see CCITT Recommendation I.330.

The Calling party subaddress information element is coded as shown in figure 4.17 and table 4.11.

The maximum length of this information element is 23 octets.

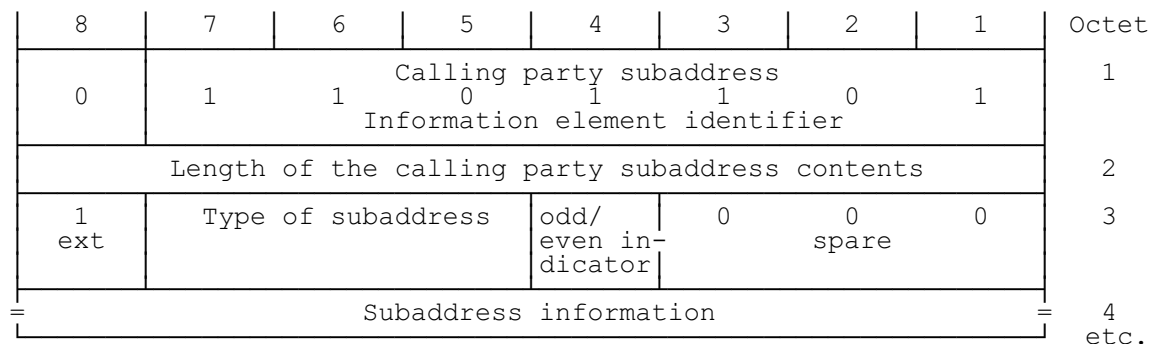

Figure 4.17: Calling party subaddress information element

Table 4.11: Calling party subaddress information element

Type of subaddress (octet 3)

Bits

7 6 5

0 0 0 NSAP (X.213/ISO 8348 AD2)

0 1 0 user specified

All other values are reserved.

Odd/even indicator (octet 3)

Bit

4

0 even number or address signals

1 odd number or address signals

NOTE: The odd/even indicator is used when the type of subaddress is "user specified" and the coding is BCD.

Subaddress information (octet 4, etc)

The NSAP X.213/ISO 8348 AD2 address, shall be formatted as specified by octet 4 which contains the Authority and Format Identifier (AFI). The encoding is made according to the "preferred binary encoding" as defined in X.213/ISO 8348 AD2. For the definition of this type of subaddress, see CCITT Recommendation I.334. Coding examples are given in Annex H.

For user-specified subaddress, this field is encoded according to the user specification, subject to a maximum length of 20 octets. When interworking with X.25 networks BCD coding should be applied.

NOTE 1: It is recommended that users apply the NSAP subaddress type since this subaddress type allows the use of decimal, binary and IA5 syntaxes in a standardized manner.

NOTE 2: When the Initial Domain Identifier (IDI) format is "local", the AFI field is coded "50" in BCD. IA5/ISO646 character syntax DSP is then represented by converting each character to a number in the range 32-127 using the T.50/ ISO646 encoding, with zero parity and the parity bit in the most significant position, yielding a binary octet in the range 0010 0000 - 0111 1111.

NOTE 3: It is recommended that users apply the local IDI format when the subaddress is used for terminal selection purposes. In this case the IA5 character syntax using only digits 0 to 9 shall be used for the DSP

4.5.12 Cause

The purpose of the Cause information element is to describe the reason for generating certain messages, to provide diagnostic information in the event of procedural errors and to indicate the location of the cause originator.

The cause information element is coded as shown in Figure 4.18 and tables 4.12 and 4.13. The maximum length of this information element is 32 octets.

The cause information element and diagnostic may be repeated in a message, e.g. to report multiple errors associated with a single call, but only one cause value is transferred to the remote user through the network.

8	7	6	5	4	3	2	1	Octet
0	0	0	0	1	0	0	0	1
Cause Information element identifier								
Length of the cause contents								2
0/1 etc	Coding Standard		0 Spare	Location				3
1 ext	Recommendation							3a*
1 ext	Cause Value							4
Diagnostic(s) (if any)								5

NOTE: If the default value applies for the Recommendation field octet 3a shall be omitted.

Figure 4.18: Cause information element

Table 4.12 (1 of 2): Cause information element

Coding standard (octet 3)

Bits

7 6

0 0	CCITT standardized coding, as described below
0 1	reserved for other international standards (NOTE)
1 0	national standard (NOTE)
1 1	standard specific to identified location (NOTE)

NOTE: These other coding standards should be used only when the desired cause cannot be represented with CCITT standardized coding.

Location (octet 3)

Bits

4 3 2 1

0 0 0 0	user
0 0 0 1	private network serving the local user
0 0 1 0	public network serving the local user
0 0 1 1	transit network
0 1 0 0	public network serving the remote user
0 1 0 1	private network serving the remote user
0 1 1 1	international network
1 0 1 0	network beyond interworking point

All other values are reserved.

NOTE 1: Depending on the location of the users, the local public network and remote public network may be the same network.

NOTE 2: Examples of location values to be used for various busy/congestion conditions appear in Annex J.

Recommendation (octet 3a) (NOTE 1)

Bits

7 6 5 4 3 2 1

0 0 0 0 0 0	Q.931 (NOTE 2)
0 0 0 0 0 1 1	X.21
0 0 0 0 1 0 0	X.25

All other values are reserved.

NOTE 1: If octet 3a is omitted, Recommendation Q.931 is assumed.

NOTE 2: This value is used only when octet 3a is extended and the cause in octet 4 is from table 4.13

Table 4.12 (2 of 2): Cause information element

Cause value (octet 4)

The cause value is divided in two fields, a class (bits 5 through 7) and a value within the class (bits 1 through 4).

The class indicates the general nature of the event.

Class (000):	normal event
Class (001):	normal event
Class (010):	resource unavailable
Class (011):	service or option not available
Class (100):	service or option not implemented
Class (101):	invalid message (e.g. parameter out of range)
Class (110):	protocol error (e.g. unknown message)
Class (111):	interworking

The cause values are listed in table 4.13 below, and defined in Annex G and Appendix I.

Diagnostics (octet 5)

Diagnostic information is not available for every cause, see table 4.13 below. The inclusion of diagnostics is optional. When available the coding of diagnostic(s) is the same as for the corresponding information element in §4.

Table 4.13 (1 of 3): Cause information element

Cause Value		Cause Number	Cause	Diagnostics
Class Bits 7 6 5	Value Bits 4 3 2 1			
0 0 0	0 0 0 1	1	Unallocated (unassigned) number	NOTE 12
0 0 0	0 0 1 0	2	No route to specified transit network	Transit network identity (NOTE 11)
0 0 0	0 0 1 1	3	No route to destination	NOTE 12
0 0 0	0 1 1 0	6	Channel unacceptable	-
0 0 0	0 1 1 1	7	Call awarded and being delivered in an established channel	-
0 0 1	0 0 0 0	16	Normal call clearing	NOTE 12
0 0 1	0 0 0 1	17	User busy	-
0 0 1	0 0 1 0	18	No user responding	-
0 0 1	0 0 1 1	19	No answer from user (user alerted)	-
0 0 1	0 1 0 1	21	Call rejected	NOTE 12 User supplied diagnostic (NOTE 4)
0 0 1	0 1 1 0	22	Number changed	New destination (NOTE 5)
0 0 1	1 0 1 0	26	Non-selected user clearing	-
0 0 1	1 0 1 1	27	Destination out of order	-
0 0 1	1 1 0 0	28	Invalid number format	-
0 0 1	1 1 0 1	29	Facility rejected	Facility identification (NOTE 1)
0 0 1	1 1 1 0	30	Response to STATUS ENQUIRY	-
0 0 1	1 1 1 1	31	Normal, unspecified	-
0 1 0	0 0 1 0	34	No circuit/channel available	-
0 1 0	0 1 1 0	38	Network out of order	-
0 1 0	1 0 0 1	41	Temporary failure	-
0 1 0	1 0 1 0	42	Switching equipment congestion	-
0 1 0	1 0 1 1	43	Access information discarded	Discarded information element identifier(s) (NOTE 6)
0 1 0	1 1 0 0	44	Requested circuit/channel not available	-
0 1 0	1 1 1 1	47	Resources unavailable, unspecified	-

Table 4.13 (2 of 3): Cause information element

Cause Value		Cause Number	Cause	Diagnostics
Class Bits 7 6 5	Value Bits 4 3 2 1			
0 1 1	0 0 0 1	49	Quality of service unavailable	NOTE 12
0 1 1	0 0 1 0	50	Requested facility not subscribed	Facility identification (NOTE 1) (NOTE 3)
0 1 1	1 0 0 1	57	Bearer capability not authorized	(NOTE 3)
0 1 1	1 0 1 0	58	Bearer capability not presently available	-
0 1 1	1 1 1 1	63	Service or option not available, unspecified	-
1 0 0	0 0 0 1	65	Bearer capability not implemented	(NOTE 3)
1 0 0	0 0 1 0	66	Channel type not implemented	Channel type (NOTE 7)
1 0 0	0 1 0 1	69	Requested facility not implemented	Facility identification (NOTE 1)
1 0 0	0 1 1 0	70	Only restricted digital information bearer capability is available	-
1 0 0	1 1 1 1	79	Service or option not implemented, unspecified	-
1 0 1	0 0 0 1	81	Invalid call reference value	-
1 0 1	0 0 1 0	82	Identified channel does not exist	Channel identity
1 0 1	0 0 1 1	83	A suspended call exists, but this call identity does not	-
1 0 1	0 1 0 0	84	Call identity in use	-
1 0 1	0 1 0 1	85	No call suspended	-
1 0 1	0 1 1 0	86	Call having the requested call identity has been cleared	Clearing cause
1 0 1	1 0 0 0	88	Incompatible destination	Incompatible parameter (NOTE 2)
1 0 1	1 0 1 1	91	Invalid transit network selection	-
1 0 1	1 1 1 1	95	Invalid message, unspecified	-

Table 4.13 (3 of 3): Cause information element

Cause Value		Cause Number	Cause	Diagnostics
Class Bits 7 6 5	Class Bits 4 3 2 1			
1 1 0	0 0 0 0	96	Mandatory information element is missing	Information element identifier(s) (NOTE 6)
1 1 0	0 0 0 1	97	Message type non-existent or not implemented	Message type
1 1 0	0 0 1 0	98	Message not compatible with call state or message type non-existent or not implemented	Message type
1 1 0	0 0 1 1	99	Information element non-existent or not implemented	Information element identifier(s) (NOTES 6, 8)
1 1 0	0 1 0 0	100	Invalid information element contents	Information element identifier(s) (NOTE 6)
1 1 0	0 1 0 1	101	Message not compatible with call state	Message type
1 1 0	0 1 1 0	102	Recovery on timer expiry	Timer number (NOTE 9)
1 1 0	1 1 1 1	111	Protocol error, unspecified	-
1 1 1	1 1 1 1	127	Interworking, unspecified	-

All other values are reserved.

NOTE 1: The coding of facility identification is network dependent.

NOTE 2: Incompatible parameter is composed of incompatible information element identifier.

NOTE 3: The format of the diagnostic field for causes number 57, 58 and 65 is as shown in figure 4.19 and table 4.14.

NOTE 4: User supplied diagnostics field is encoded according to the user specification, subject to the maximum length of the Cause information element. The coding of user supplied diagnostics should be made in such a way that it does not conflict with the coding described in NOTE 12 below.

NOTE 5: New destination is formatted as the Called party number information element, including information element identifier. Transit network selection may also be included.

NOTE 6: Locking and non-locking shift procedures described in §4.5 are applied. In principle, information element identifiers are ordered in the same order as the information elements in the received message.

NOTE 7: The following coding is used:

Bit 8: Extension bit

Bit 7-5: spare

Bit 4-1: according to the table 4.15 octet 3.2, channel type.

NOTE 8: When only Locking shift information element is included and no variable length information element identifier follows, it means that the codeset in the locking shift itself is not implemented.

NOTE 9: The timer number is coded in IA5 characters, e.g. T308 is coded as '3' '0' '8'. The following coding is used in each octet:

Bit 8: Spare "0"

Bit 7-1: IA5 character

NOTE 10: Examples of cause values to be used for various busy/congestion conditions appear in Annex J.

NOTE 11: The diagnostic field contains the entire Transit network selection or Network specific facilities information element, as applicable.

NOTE 12: The following coding is used:

Bit 8: 1
 Bits 7-3: 00000
 Bits 2-1: condition as follows:
 00 - unknown
 01 - permanent
 10 - transient.

8	7	6	5	4	3	2	1	Octet
0/1 ext	Attribute number							5
0/1 ext	Rejected attribute							5a
1 ext	Available attribute							5b

NOTE 1: When diagnostics information is provided, octet 5 and 5a shall be present. Octet 5b is optional.

NOTE 2: Octets 5-5b may be repeated to report multiple rejected attributes.

Figure 4.19: Coding of the diagnostic field for causes number 57, 58 and 65

Table 4.14 (1 of 2): Coding of the diagnostic field for causes number 57, 58 and 65

Attribute Number (octet 5)

Bits	No.	
7 6 5 4 3 2 1		
0 1 1 0 0 0 1	1	Information transfer capability
0 1 1 0 0 1 0	2	Information transfer mode
0 1 1 0 0 1 1	3	Information transfer rate
0 1 1 0 1 0 0	4	Structure
0 1 1 0 1 0 1	5	Configuration
0 1 1 0 1 1 0	6	Establishment
0 1 1 0 1 1 1	7	Symmetry
0 1 1 1 0 0 0	8	Information transfer rate (dest → orig)
0 1 1 1 0 0 1	9	Layer identification

Table 4.14 (2 of 2): Coding of the diagnostic field for causes number 57, 58 and 65

Rejected attribute (octet 5a)

Attribute No.

[1]	Information transfer capability:	Bits 7-6: Bits 5-1:	00 according to table 4.6, octet 3.
[2]	Information transfer mode:	Bits 7-6: Bits 5-1:	according to table 4.6, octet 4. 00000
[3]	Information transfer rate:	Bits 7-6: Bits 5-1:	00 according to table 4.6, octet 4.
[4]	Structure:	Bits 7-5: Bits 4-1:	according to table 4.6, octet 4a. 0000
[5]	Configuration:	Bits 7-5: Bits 4-3: Bits 2-1:	000 according to table 4.6, octet 4a. 00
[6]	Establishment:	Bits 7-3: Bits 2-1:	00000 according to table 4.6, octet 4a.
[7]	Symmetry	Bits 7-6: Bits 5-1:	according to table 4.6, octet 4b. 00000
[8]	Information transfer rate (dest → orig):	Bits 7-6: Bits 5-1:	00 according to table 4.6, octet 4b
[9]	Layer identification:	Bits 7 6 0 1 (Layer 1) 1 0 (Layer 2) 1 1 (Layer 3)	Bits 5-1 according to table 4.6, octet 5 Bits 5-1 according to table 4.6, octet 6 Bits 5-1 according to table 4.6, octet 7

Available attributes (octet 5b)

The same coding as octet 5a.

ETSI Cause values:

The coding of octet 3 and 5 is the same as defined for CCITT standardized cause values (see table 4.12). Coding standard (octet 3) shall be coded "1 0" (National standard).

For the cause value (octet 4) it is recommended that in allocating national cause values the classification used for the CCITT coding standard is used also for national standard. In coding the specific cause values the principle shown below should be followed.

Class Value

7 6 5	4 3 2 1	
X X X	0 X X X	national standard
X X X	1 X X X	ETSI standard

The ETSI cause values are defined below:

Cause Value		Cause Number	Cause	Diagnostics
Class Bits	Value Bits			
7 6 5	4 3 2 1			
1 0 1	1 0 0 0	88	Non-existent closed user group (ETSI NOTE)	-
1 0 1	1 0 0 1	89	Called user not member of CUG (ETSI NOTE)	-
1 0 1	1 0 1 0	90	Called user belongs to CUG (ETSI NOTE)	-

ETSI NOTE: This cause value is used for the support of stimulus mode of the Closed User Group supplementary service.

4.5.13 Channel identification

The purpose of the Channel identification information element is to identify a channel within the interface(s) controlled by these signalling procedures.

The Channel identification information element is coded as shown in figures 4.20 and table 4.15. The Channel identification information element may be repeated in a message; e.g. to list several acceptable channels during channel negotiation.

Examples of the coding of the Channel identification information element are shown in Annex H.

The default maximum length for this information element is network dependent.

8	7	6	5	4	3	2	1	Octet	
0	Channel identification Information element identifier						0	0	1
Length of channel identification contents								2	
1 ext	Int id present	Int. type	0 Spare	Pref./ excl.	D-chan. nel ind	Info. channel selection		3	
0/1 ext	Interface identifier							3.1* etc. (NOTE 1)	
1 ext	Coding standard		Number/ Map	Channel type/ Map identifier type				3.2* (NOTE 2)	
Channel number/slot map (NOTE 3)								3.3* (NOTE 2) (NOTE 4)	

NOTE 1: When the "interface identifier present" field in octet 3 indicates "interface implicitly identified" octet 3.1 is omitted. When octet 3.1 is present it may be extended by using the extension bit (bit 8).

NOTE 2: When the "interface type" field in octet 3 indicates "basic interface", octets 3.2 and 3.3 are functionally replaced by the "information channel selection" field in octet 3, and thus omitted.

NOTE 3: When channel number is used, bit 8 is reserved for use as an extension bit and is thus set to "1".

NOTE 4: When channel number is used, this octet may be repeated to indicate multiple channels.

Figure 4.20: Channel identification information element

Table 4.15 (1 of 2): Channel identification information element

Interface identifier present (octet 3)

Bit	
7	
0	interface implicitly identified (NOTE)
1	interface explicitly identified in one or more octets beginning with octet 3.1 (ETSI NOTE)

NOTE: The interface which includes the D-channel carrying this information element is indicated.

ETSI NOTE: Not applicable in ISDNs conforming to this ETS.

Interface type (octet 3)

Bit	
6	
0	basic interface
1	other interface: e.g. primary rate (NOTE) (ETSI NOTE)

NOTE: The type of interface should be understood because the interface is identified by the "interface identifier present" field (octet 3, bit 7) and the interface identifier field (octet 3.1), if any.

ETSI NOTE: In ISDNs conforming to this ETS, this codepoint is only applied for the primary rate interface.

Preferred/exclusive (octet 3)

Bit	
4	
0	indicated channel is preferred
1	exclusive: only the indicated channel is acceptable

NOTE: Preferred/exclusive has significance only for B-channel selection.

D-channel indicator (octet 3)

Bit	
3	
0	the channel identified is not the D-channel
1	the channel identified is the D-channel

NOTE: D-channel indication has significance in D-channel use. No other information affects D-channel use.

Information channel selection (octet 3) (NOTE)

Bits		
2 1	Basic interface	Other interfaces
0 0	no channel	no channel
0 1	B1 channel	as indicated in following octets
1 0	B2 channel	reserved
1 1	any channel	any channel

NOTE: The information channel selection does not apply to the D-channel.

Table 4.15 (2 of 2): Channel identification information element

Interface identifier (octet 3.1) (ETSI NOTE)

Binary code assigned to the interface at subscription time. At subscription time the binary code for the interface identifier will specify the number of octets to be used and the content of each octet.

NOTE: When the interface is implicitly identified, octet 3.1 is omitted.

ETSI NOTE: Not applicable in ISDNs conforming to this ETS.

Coding standard (octet 3.2)

Bits

7 6

0 0 CCITT standardized coding as described below

0 1 reserved for other international standards (NOTE)

1 0 national standard (NOTE)

1 1 standard defined for the network (either public or private) present on the network side of the interface (NOTE)

NOTE: These other coding standards should be used only when the desired channel identification cannot be represented with the CCITT standardized coding.

Number/map (octet 3.2)

Bit

5

0 channel is indicated by the number in the following octet

1 channel is indicated by the slot map (Map) in the following octet(s). (ETSI NOTE)

ETSI NOTE: Not applicable in ISDNs conforming to this ETS.

Channel type/map element type (octet 3.2)

Bits

4 3 2 1

0 0 1 1 B-channel units

0 1 1 0 H0-channel units

1 0 0 0 H11-channel units

1 0 0 1 H12-channel units

All other values are reserved.

Channel number (octet 3.3)

Binary number assigned to the channel. For B-channels, the channel number equals the time slot number. See Recommendation I.431.

NOTE: Either "Channel number" or "Slot map" is used exclusively, depending on the "Number/map" information. in networks conforming to this ETS.

Slot map (octet 3.3)

ETSI NOTE: Not applicable in ISDNs conforming to this ETS

4.5.14 Congestion level

The purpose of the Congestion level information element is to describe the congestion status of the call. It is a single octet information element coded as shown in figure 4.22 and table 4.16.

8	7	6	5	4	3	2	1	Octet
1	Congestion level 0 1 1			Congestion level				1
	Information element id.							

Figure 4.22: Congestion level information element

Table 4.16: Congestion level information element

Congestion level (octet 1)

Bits
 4 3 2 1
 0 0 0 0 receiver ready
 1 1 1 1 receiver not ready
 All other values are reserved.

4.5.15 Display

The purpose of the Display information element is to supply display information that may be displayed by the user. The information contained in this information element is coded in IA5 characters.

The Display information element is coded as shown in figure 4.23.

The Display information element has a network dependent default maximum length of 34 or 82 octets. The evolution to a single maximum value of 82 octets is an objective. If a user receives a Display information element with a length exceeding the maximum length which the user can handle, the information element should be truncated by the user.

8	7	6	5	4	3	2	1	Octet
0	0	1	0	1	0	0	0	1
Display Information element identifier								
Length of display contents								2
0	Display information (IA5 characters)							3 etc.

ETSI NOTE: The IA5 character string in the "display" field shall be coded using appropriate national IA5 tables.

Figure 4.23: Display information element

4.5.16 High layer compatibility

The purpose of the High layer compatibility information element is to provide a means which should be used by the remote user for compatibility checking. See Annex B.

The High layer compatibility information element is coded as shown in figure 4.24 and table 4.17.

The maximum length of this information element is five octets.

NOTE: The High layer compatibility information element is transported transparently by an ISDN between a call originating entity, e.g. a calling user and the addressed entity, e.g. a remote user or high layer function network node addressed by the call originating entity. However, if explicitly requested by the user (at subscription time), a network which provides some capabilities to realise teleservices may interpret this information to provide a particular service.

8	7	6	5	4	3	2	1	Octet
0	1	1	1	1	1	0	1	1
High layer compatibility Information element identifier								
Length of high layer compatibility contents								2
1 ext	Coding standard		Interpretation			Presentation method of pro- tocol profile		3
0/1 ext	High layer characteristics identification							4
1 ext	Extended high layer characteristics identification							4a* (NOTE)

NOTE: This octet may be present when octet 4 indicates Maintenance or Management.

Figure 4.24: High layer compatibility information element

Table 4.17 (1 of 3): High layer compatibility information element

Coding standard (octet 3)

Bits

7 6

- 0 0 CCITT standardized coding as described below
- 0 1 reserved for other international standards (NOTE)
- 1 0 national standard (NOTE)
- 1 1 standard defined for the network (either public or private) present on the network side of the interface (NOTE).

NOTE: These other coding standards should be used only when the desired high layer compatibility cannot be represented with the CCITT-standardized coding.

Interpretation (octet 3)

Bits

5 4 3

- 1 0 0 First (primary only) high layer characteristics identification (in octet 4) to be used in the call.

All other values are reserved.

NOTE 1: "Interpretation" indicates how the "High layer characteristics identification" (in octet 4) should be interpreted.

NOTE 2: Currently, "Interpretation" has only a single value. However, "Interpretation", when enhanced, will be able to indicate how the "High layer characteristics identification" in the same information element shall be interpreted when multiple "High layer characteristics identifications" are used and exact relationship among them needs to be indicated (e.g. sequential usage, alternative list, simultaneous usage). Such enhancements in conjunction with the possible negotiation procedures is left for further study.

Presentation method of protocol profile (octet 3)

Bits

2 1

- 0 1 High layer protocol profile (without specification of attributes)

All other values are reserved.

NOTE: Currently, "Presentation method of protocol profile" has only a single value, i.e. a "profile value" is used to indicate a service to be supported by high layer protocols as required. Necessity of other presentation methods, e.g. service indications in the form of layer-by-layer indication of protocols to be used in high layers, is left for further study.

Table 4.17 (2 of 3): High layer compatibility information element

High layer characteristics identification (octet 4)

Bits

7 6 5 4 3 2 1

0 0 0 0 0 0 1

Telephony (Recommendation G.711)

0 0 0 0 1 0 0

Facsimile Group 2/3 (Recommendation T.62 F.182)

0 1 0 0 0 0 1

Document application profile for Facsimile Group 4 Class 1 Facsimile (Recommendation T.503 F.184)

0 1 0 0 1 0 0

Document application profile for formatted mixed-mode (Recommendation T.501) Teletex service, basic and mixed mode of operation (Recommendation F.230) and facsimile service Group 4, Classes II and III (Recommendation F.184)

0 1 0 1 0 0 0

Document application profile for Processable- form (Recommendation T.502) Teletex service, basic and processable mode of operation (Recommendation F.220)

0 1 1 0 0 0 1

Teletex service, basic mode of operation (Recommendations T.62, T.70 F.200)

0 1 1 0 0 1 0

Document application profile International interworking for Videotex services interworking between gateways (Recommendations T.504 F.300 and T.101)

0 1 1 0 1 0 1

Telex service (Recommendation F.60)

0 1 1 1 0 0 0

Message Handling Systems (MHS) (Recommendation X.400 series)

1 0 0 0 0 0 1

OSI application (NOTE 2) (Recommendation X.200 series)

1 0 1 1 1 1 0

Reserved for Maintenance (NOTE 4)

1 0 1 1 1 1 1

Reserved for Management (NOTE 4)

1 1 1 1 1 1 1

Reserved

All other values are reserved

NOTE 1: The coding above applies in case of "Coding standard" = "CCITT standard" and "Presentation method of protocol profile" = "High layer protocol profile".

NOTE 2: Further compatibility checking will be executed by the OSI high layer protocol.

NOTE 3: Code points are added only to those services for which CCITT Recommendations are available. See also Recommendation I.241.

NOTE 4: When this coding is included, octet 4 may be followed by octet 4a.

Table 4.17 (3 of 3): High layer compatibility information element

Extended high layer characteristics identification (octet 4a)

Bits	
7 6 5 4 3 2 1	
0 0 0 0 0 1	Telephony (Recommendation G.711)
0 0 0 0 1 0 0	Facsimile Group 2/3 (Recommendation T.62 F.182)
0 1 0 0 0 0 1	Document application profile for Facsimile Group 4 Class I Facsimile (Recommendation T.503 F.184)
0 1 0 0 1 0 0	Document application profile for formatted mixed-mode (Recommendation T.501) Teletex service, basic and mixed mode of operation (Recommendation F.230) and facsimile service Group 4, Classes II and III (Recommendation F.184)
0 1 0 1 0 0 0	Document application profile for Processable form (Recommendation T.502) Teletex service, basic and processable mode of operation (Recommendation F.220)
0 1 1 0 0 0 1	Teletex service, basic mode of operation (Recommendations T.62, T.70 F.200)
0 1 1 0 0 1 0	Document application profile International interworking for Videotex services interworking between gateways (Recommendations T.504 F.300 and T.101)
0 1 1 0 1 0 1	Telex service (Recommendation F.60)
0 1 1 1 0 0 0	Message Handling Systems (MHS) (Recommendation X.400 series)
1 0 0 0 0 0 1	OSI application (Recommendation X.200 series)
1 0 1 1 1 1 0	Not available for assignment
1 0 1 1 1 1 1	Not available for assignment
1 1 1 1 1 1 1	Reserved

All other values are reserved.

4.5.17 Keypad facility

The purpose of the Keypad facility information element is to convey IA5 characters, e.g. entered by means of a terminal keypad.

The Keypad facility information element is coded as shown in figure 4.25. The default maximum length of this information element is 34 octets.

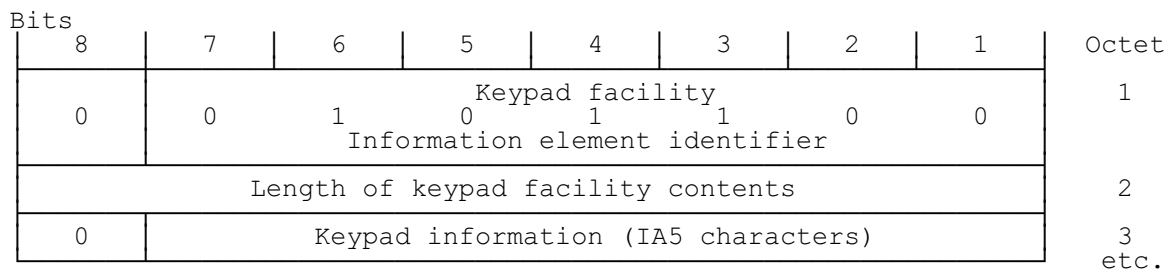

Figure 4.25: Keypad facility information element

4.5.18 Low layer compatibility

The purpose of the Low layer compatibility information element is to provide a means which should be used for compatibility checking by an addressed entity (e.g. a remote user or an interworking unit or a high layer function network node addressed by the calling user). The Low layer compatibility information element is transferred transparently by an ISDN between the call originating entity (e.g. the calling user) and the addressed entity. See Annex B and Annex L.

If Low layer compatibility negotiation is allowed by the network (see Annex M), the Low layer compatibility information element is also passed transparently from the addressed entity to the originating entity.

The Low layer compatibility information element is coded as shown in figure 4.26 and table 4.18. The maximum length of this information element is 16 octets.

8	7	6	5	4	3	2	1	Octet
0	1	1	1	1	1	0	0	1
Low layer compatibility Information element identifier								
Length of the low layer compatibility contents								2
0/1 ext	coding standard	information transfer capability						3
1 ext	Negot. indic.	0	0	0	0	0	0	3a* (ETSI Note) 4
		Spare						
0/1 ext	transfer mode		information transfer rate					
0/1 ext	structure			configuration		establishment		4a* (Note 1)
1 ext	symmetry		information transfer rate (destination -> origination)					4b* (Note 1)
0/1 ext	0	1	user information layer 1 protocol					5*
		layer 1, ident.						
0/1 ext	synch./ asynch.	negot.	user rate					5a* (Note 4)
0/1 ext	intermediate rate		NIC on Tx	NIC on Rx	Flow control on Tx	Flow control on Rx	0 Spare	5b* (Note 2)
0/1 ext	Hdr/ no Hdr	Multi frame support	Mode	LLI negot.	Assign- nor/As- signee	Inband/ outband negot.	0 Spare	5b* (Note 3)
		number of stop bits						
		number of data bits		Parity				5c* (Note 4)
1 ext	duplex mode	modem type						5d* (Note 4)
0/1 ext	1	0	user information layer 2 protocol					6*
		layer 2 ident.						
1 ext	Optional layer 2 protocol information							6a*
0/1 ext	1	1	user information layer 3 protocol					7*
		layer 3 ident.						
1 ext	Optional Layer 3 protocol information							7a*

Figure 4.26: Low layer compatibility information element

- NOTE 1: If default values are used for all fields of octets 4a and 4b, then these octets shall not be included. If default values are used for all fields of octet 4b, but not for one or more fields of octet 4a, then only octet 4a shall be included. Otherwise, both octets 4a and 4b shall be included.
- NOTE 2: This octet may be present only if octet 5 indicates CCITT standardized rate adaption V.110/X.30.
- NOTE 3: This octet is present only if octet 5 indicates CCITT standardized rate adaption V.120.
- NOTE 4: This octet may be present if octet 5 indicates either of the CCITT standardized rate adaptations V.110/X.30 or V.120.

ETSI NOTE: This octet shall be present if out-band negotiation is required.

Table 4.18 (1 of 8): Low Layer compatibility information element

Coding standard (octet 3)

Bits

7 6

- 0 0 CCITT standardized coding as described below
- 0 1 reserved for other international standards (NOTE)
- 1 0 national standard (NOTE)
- 1 1 standard defined for the network (either public or private) present on the network side of the interface (NOTE)

NOTE: These other coding standards should be used only when the desired low layer compatibility cannot be represented with the CCITT standardized coding.

Information transfer capability (octet 3)

Bits

5 4 3 2 1

- 0 0 0 0 speech
- 0 1 0 0 unrestricted digital information
- 0 1 0 1 restricted digital information
- 1 0 0 0 3.1 kHz audio
- 1 0 0 1 7 kHz audio
- 1 1 0 0 video

All other values are reserved.

Negotiation indicator (octet 3a)

Bit

7

- 0 out-band negotiation not possible
- 1 out-band negotiation possible

NOTE 1: See Annex M for description of low layer compatibility negotiation.

NOTE 2: When octet 3a is omitted, "out-band negotiation not possible" shall be assumed.

Transfer mode (octet 4)

Bits

7 6

- 0 0 circuit mode
- 1 0 packet mode

All other values are reserved.

Table 4.18 (2 of 8): Low Layer compatibility information element

Information transfer rate (octets 4 and 4b)

Bits	Circuit Mode	Packet Mode
5 4 3 2 1		
0 0 0 0 0	-	This code shall be used for packet-mode calls
1 0 0 0 0	64 kbit/s	-
1 0 0 0 1	2 x 64 kbit/s	-
1 0 0 1 1	384 kbit/s	-
1 0 1 0 1	1536 kbit/s	-
1 0 1 1 1	1920 kbit/s	-

All other values are reserved.

NOTE 1: When octet 4b is omitted, the low layer compatibility is bidirectional symmetric at the information transfer rate specified in octet 4. When octet 4b is included, the information transfer rate in octet 4 refers to the origination → destination direction.

NOTE 2: When the information transfer rate 2 x 64 kbit/s is used, the coding of octet 3 and 4 refer to both 64 kbit/s channels.

Structure (octet 4)

Bits	
7 6 5	
0 0 0	default (see NOTE 1)
0 0 1	8 kHz integrity (NOTE 2)
1 0 0	service data unit integrity
1 1 1	unstructured

All other values are reserved.

NOTE 1: If octet 4a is omitted, or the structure field is coded "000", then the value of the structure attribute is according to the following:

Transfer mode	Transfer capability	Structure
circuit	speech	8 kHz integrity
circuit	unrestricted digital	8 kHz integrity
circuit	restricted digital	8 kHz integrity
circuit	audio	8 kHz integrity
circuit	video	8 kHz integrity
packet	unrestricted digital	service data unit integrity

NOTE 2: When the information transfer rate 2 x 64 kbit/s is used, 8 kHz integrity with Restricted Differential Time Delay (RDTD) is offered.

Configuration (octet 4a)

Bits	
4 3	
0 0	point-to-point

All other values are reserved.

NOTE: If octet 4a is omitted, the configuration is assumed to be point-to-point.

Table 4.18 (3 of 8): Low layer compatibility information element

Establishment (octet 4a)

Bits
2 1
0 0 demand
All other values are reserved.

NOTE: If octet 4a is omitted, the method of establishment is assumed to be "demand".

Symmetry (octet 4b)

Bits
7 6
0 0 bidirectional symmetric
All other values are reserved.

NOTE: If octet 4b is omitted, bidirectional symmetric is assumed.

User information layer 1 protocol (octet 5)

Bits
5 4 3 2 1
0 0 0 0 1 CCITT standardized rate adaption V.110/X.30. This implies the presence of octet 5a and optionally octet 5b, 5c and 5d as defined below
0 0 0 1 0 Recommendation G.711 μ -law
0 0 0 1 1 Recommendation G.711 A-law
0 0 1 0 0 Recommendation G.721 32 kbit/s ADPCM and Recommendation I.460
0 0 1 0 1 Recommendation G.722 and G.725 7 kHz audio
0 0 1 1 0 Recommendation G.7xx 384 kbit/s video
0 0 1 1 1 Non-CCITT standardized rate adaption. This implies the presence of octet 5a and, optionally, octets 5b, 5c and 5d. The use of this code point indicates that the user rate specified in octet 5a is defined by the user. Additionally, octets 5b, 5c and 5d, if present, are defined consistent with the user specified rate adaption
0 1 0 0 0 CCITT standardized rate adaption V.120. This implies the presence of octets 5a and 5b as defined below and optionally octets 5c and 5d.
0 1 0 0 1 CCITT standardized rate adaption X.31 HDLC flag stuffing

All other values are reserved.

NOTE: If the transfer mode is "circuit mode", and if the information transfer capability is "unrestricted digital information" or "restricted digital information", and if the user information layer 1 protocol is not to be identified to the network, octet 5 shall be omitted. If the transfer mode is "packet mode", octet 5 may be omitted. Otherwise, octet 5 shall be present.

Synchronous/asynchronous (octet 5a)

Bit
7
0 synchronous
1 asynchronous

NOTE: Octets 5b-5d may be omitted in case of synchronous user rates.

Table 4.18 (4 of 8): Low layer compatibility information element

Negotiation (octet 5a)

Bit	
6	
0	in-band negotiation not possible
1	in-band negotiation possible

NOTE: See Recommendations V.110 and X.30.

User rate (octet 5a)

Bits	
<u>5 4 3 2 1</u>	
0 0 0 0 0	rate is indicated by E-bits specified in Rec. I.460
0 0 0 0 1	0.6 kbit/s Recommendations V.6 and X.1
0 0 0 1 0	1.2 kbit/s Recommendation V.6
0 0 0 1 1	2.4 kbit/s Recommendations V.6 and X.1
0 0 1 0 0	3.6 kbit/s Recommendation V.6
0 0 1 0 1	4.8 kbit/s Recommendations V.6 and X.1
0 0 1 1 0	7.2 kbit/s Recommendation V.6
0 0 1 1 1	8 kbit/s Recommendation I.460
0 1 0 0 0	9.6 kbit/s Recommendations V.6 and X.1
0 1 0 0 1	14.4 kbit/s Recommendation V.6
0 1 0 1 0	16 kbit/s Recommendation I.460
0 1 0 1 1	19.2 kbit/s Recommendation V.6
0 1 1 0 0	32 kbit/s Recommendation I.460
0 1 1 1 0	48 kbit/s Recommendation V.6 and X.1
0 1 1 1 1	56 kbit/s Recommendation V.6
1 0 0 0 0	64 kbit/s Recommendation X.1
1 0 1 0 1	0.1345 kbit/s Recommendation X.1
1 0 1 1 0	0.100 kbit/s Recommendation X.1
1 0 1 1 1	0.075/1.2 kbit/s Recommendations V.6 and X.1 (NOTE)
1 1 0 0 0	1.2/0.075 kbit/s Recommendations V.6 and X.1 (NOTE)
1 1 0 0 1	0.050 kbit/s Recommendations V.6 and X.1
1 1 0 1 0	0.075 kbit/s Recommendations V.6 and X.1
1 1 0 1 1	0.110 kbit/s Recommendations V.6 and X.1
1 1 1 0 0	0.150 kbit/s Recommendations V.6 and X.1
1 1 1 0 1	0.200 kbit/s Recommendations V.6 and X.1
1 1 1 1 0	0.300 kbit/s Recommendations V.6 and X.1
1 1 1 1 1	12 kbit/s Recommendation V.6

All other values are reserved.

NOTE: The first rate is the transmit rate in the forward direction of the call. The second rate is the transmit rate in the backward direction of the call.

* Octet 5b for V.110/X.30 rate adaption *

Intermediate rate (octet 5b)

Bits	
<u>7 6</u>	
0 0	not used
0 1	8 kbit/s
1 0	16 kbit/s
1 1	32 kbit/s

Table 4.18 (5 of 8): Low layer compatibility information element

Network Independent Clock (NIC) on Transmission (Tx) (octet 5b) (NOTE 1)

Bit	
5	
0	not required to send data with Network Independent Clock
1	required to send data with Network Independent Clock

NOTE 1: Refers to transmission in the forward direction of the call.

NOTE 2: See Recommendations V.110 and X.30.

Network Independent Clock (NIC) on Reception (Rx) (octet 5b) (NOTE 1)

Bit	
4	
0	cannot accept data with Network Independent Clock (i.e. sender does not support this optional procedure)
1	can accept data with Network Independent Clock (i.e. sender does support this optional procedure)

NOTE 1: Refers to transmission in the backward direction of the call.

NOTE 2: See Recommendations V.110 and X.30.

Flow control on Transmission (Tx) (octet 5b) (NOTE 1)

Bit	
3	
0	Not required to send data with flow control mechanism
1	Required to send data with flow control mechanism

NOTE 1: Refers to transmission in the forward direction of the call.

NOTE 2: See Recommendations V.110 and X.30.

Flow control on Reception (Rx) (octet 5b) (NOTE 1)

Bit	
2	
0	cannot accept data with flow control mechanism (i.e. sender does not support this optional procedure)
1	can accept data with flow control mechanism (i.e. sender does support this optional procedure)

NOTE 1: Refers to transmission in the backward direction of the call.

NOTE 2: See Recommendations V.110 and X.30.

* Octet 5b for V.120 rate adaption *

Rate adaption header/no header (octet 5b)

Bit	
7	
0	rate adaption header not included
1	rate adaption header included

Table 4.18 (6 of 8): Low layer compatibility information element

Multiple frame establishment support in Data link (octet 5b)

Bit

6

- 0 multiple frame establishment not supported, only UI frames allowed.
- 1 multiple frame establishment supported.

Mode of operation (octet 5b)

Bit

5

- 0 bit transparent mode of operation
- 1 protocol sensitive mode of operation

Logical link identifier negotiation (octet 5b)

Bit

4

- 0 default, LLI = 256 only
- 1 full protocol negotiation (NOTE)

NOTE: A connection over which protocol negotiation will be executed is indicated in bit 2 of octet 5b.

Assignor/assignee (octet 5b)

Bit

3

- 0 message originator is "Default assignee"
- 1 message originator is "Assignor only"

In-band/outband negotiation (octet 5b)

Bit

2

- 0 negotiation is done with USER INFORMATION messages on a temporary signalling connection
- 1 negotiation is done in-band using logical link zero

Number of stop bits (octet 5c)

Bits

7 6

- 0 0 not used
- 0 1 1 bit
- 1 0 1.5 bits
- 1 1 2 bits

Number of data bits excluding parity bit if present (octet 5c)

Bits

5 4

- 0 0 not used
- 0 1 5 bits
- 1 0 7 bits
- 1 1 8 bits

Table 4.18 (7 of 8): Low layer compatibility information element

Parity information (octet 5c)

Bits	
<u>3 2 1</u>	
0 0 0	odd
0 1 0	even
0 1 1	none
1 0 0	forced to 0
1 0 1	forced to 1

All other values are reserved.

Duplex mode (octet 5d)

Bit	
<u>7</u>	
0	half duplex
1	full duplex

Modem type (octet 5d)

ETSI requirement: The following coding of this field is applicable for ISDNs conforming to this ETS.

Bits	
<u>6 5 4 3 2 1</u>	
0 0 0 0 0 0	Reserved
0 0 0 0 0 1	V.21
0 0 0 0 1 0	V.22
0 0 0 0 1 1	V.22 bis
0 0 0 1 0 0	V.23
0 0 0 1 0 1	V.26
0 0 0 1 1 0	V.26 bis
0 0 0 1 1 1	V.26 ter
0 0 1 0 0 0	V.27
0 0 1 0 0 1	V.27 bis
0 0 1 0 1 0	V.27 ter
0 0 1 0 1 1	V.29
0 0 1 1 0 0	V.32
0 0 1 1 0 1	V.35
1 0 0 0 0 0 }	
through }	Reserved for national use.
1 1 1 1 1 1 }	

All other values are reserved.

Table 4.18 (8 of 8): Low layer compatibility information element

User information layer 2 protocol (octet 6)

Bits	
5 4 3 2 1	
0 0 0 0 1	Basic mode ISO 1745
0 0 0 1 0	CCITT Recommendation Q.921 (I.441)
0 0 1 1 0	CCITT Recommendation X.25 link layer
0 0 1 1 1	CCITT Recommendation X.25 Multilink
0 1 0 0 0	Extended LAPB; for half duplex operation (T.71)
0 1 0 0 1	HDLC ARM (ISO 4335)
0 1 0 1 0	HDLC NRM (ISO 4335)
0 1 0 1 1	HDLC ABM (ISO 4335)
0 1 1 0 0	LAN Logical link control (ISO 8802/2)
0 1 1 0 1	CCITT Recommendation X.75 Single Link Procedure (SLP)

All other values are reserved.

Optional layer 2 protocol information (octet 6a)

User specified To be specified.

User information layer 3 protocol (octet 7)

Bits	
5 4 3 2 1	
0 0 0 1 0	CCITT Recommendation Q.931 (I.451)
0 0 1 1 0	CCITT Recommendation X.25, packet layer
0 0 1 1 1	ISO 8208 (X.25 packet level protocol for data terminal equipment)
0 1 0 0 0	ISO 8348 (OSI connection oriented network service specific subset of ISO 8208 and CCITT X.25)
0 1 0 0 1	ISO 8473 (OSI connectionless service)
0 1 0 1 0	CCITT Recommendation T.70 minimum network layer

All other values are reserved.

Optional layer 3 protocol information (octet 7a)

User specified To be specified.

4.5.19 More data

The More data information element is sent by the user to the network in a USER INFORMATION message, and delivered by the network to the destination user(s) in the corresponding USER INFORMATION message. The presence of the More data information element indicates to the destination user that another USER INFORMATION message will follow, containing information belonging to the same block.

The use of the More data information element is not supervised by the network.

The More data information element is coded as shown in figure 4.27.

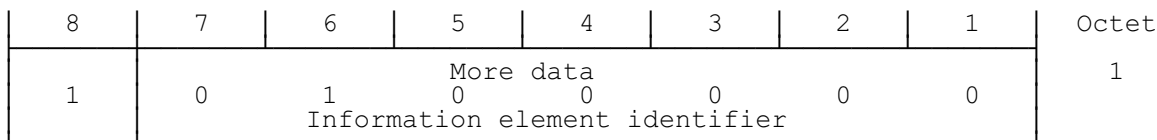

Figure 4.27: More data information element

4.5.20 Network-specific facilities

The purpose of the Network-specific facilities information element is to indicate which network facilities are being invoked. The Network-specific facilities information element is coded as shown in figure 4.28 and table 4.19. No more than four Network-specific facilities information elements may be included in a single message.

The maximum length of this information element is network dependent.

8	7	6	5	4	3	2	1	Octet
0	0	1	0	0	0	0	0	1
Network-specific facilities Information element identifier								
Length of the network-specific facilities contents								2
Length of network identification								3
1 ext	Type of network identification			Network identification plan				3.1*
0 Spare	Network identification (IA5-characters)							3.2*
Network-specific facility specification								4

NOTE 1: Octets 3.1 and 3.2 are only present when the length in octet 3 is non-zero.

NOTE 2: Octet 3.2 may be repeated as appropriate.

Figure 4.28: Network-specific facilities information element

Table 4.19: Network-specific facilities information element

Length of network identification (octet 3)

This field contains the length, in octets, of the network identification found in octet 3.1 and the repetition of octet 3.2. If the value is "0000 0000", then the default provider (see Annex E, §E.1) is assumed and octets 3.1 and 3.2 are omitted.

Type of network identification (octet 3.1)

Bits
 7 6 5
 0 0 0 user specified
 0 1 0 national network identification
 0 1 1 international network identification
 All other values are reserved.

Network identification plan (octet 3.1)

Bits
 4 3 2 1
 0 0 0 0 unknown
 0 0 0 1 Carrier Identification Code (NOTE)
 0 0 1 1 data network identification code (Recommendation X.121)
 All other values are reserved.

NOTE: Carrier Identification Codes may be an appropriate method of identifying the network serving the remote user.

Network identification (octets 3.2, etc)

These IA5 characters are organized according to the network identification plan specified in octet 3.1.

Network-specific facilities (octets 4, etc.)

This field is encoded according to the rules specified by the identified network.

4.5.21 Notification indicator

The purpose of the Notification indicator information element is to indicate information pertaining to a call.

The Notification indicator information element is coded as shown in figure 4.29 and table 4.20. The maximum length of this information element is three octets.

8	7	6	5	4	3	2	1	Octet
0	0	1	0	0	1	1	1	1
Notification indicator Information element identifier								
Length of the notification indicator contents								2
1 ext	Notification description							3

ETSI NOTE: For the coding and use of this information element in relation to the provision of supplementary services see ETS T/S 46-32B.

Figure 4.29: Notification indicator information element

Table 4.20: Notification indicator information element

Notification description (octet 3)

Bits	
7 6 5 4 3 2 1	
0 0 0 0 0 0	user suspended
0 0 0 0 0 1	user resumed
0 0 0 0 1 0	bearer service change (ETSI NOTE)
All other values are reserved.	

ETSI NOTE: Not applicable in ISDNs conforming to this ETS.

4.5.22 Progress indicator

The purpose of the Progress indicator information element is to describe an event which has occurred during the life of a call. The information element may occur two times in a message.

The Progress indicator information element is coded as shown in figure 4.30 and table 4.21. The default maximum length of this information element is 4 octets.

8	7	6	5	4	3	2	1	Octet
0	0	0	1	1	1	1	0	1
Progress indicator Information element identifier								
Length of the progress indicator contents								2
1 ext	Coding standard	0 Spare	Location					3
1	Progress description							4

Figure 4.30: Progress indicator information element

Table 4.21: Progress indicator information element

Coding standard (octet 3)

Bits	
7	6
0 0	CCITT standardized coding as described below.
0 1	reserved for other international standards (NOTE)
1 0	national standard (NOTE)
1 1	standard specific to identified location (NOTE)

NOTE: These other coding standards should be used only when the desired progress indication cannot be represented with the CCITT standardized coding.

Location (octet 3)

Bits				
4	3	2	1	
0 0 0 0				user
0 0 0 1				private network serving the local user
0 0 1 0				public network serving the local user
0 1 0 0				public network serving the remote user
0 1 0 1				private network serving the remote user
0 1 1 1				international network
1 0 1 0				network beyond interworking point

All other values are reserved.

NOTE: Depending on the location of the users, the local public network and remote public network may be the same network.

Progress description (octet 4)

Bits		No.					
7	6	5	4	3	2	1	
0 0 0 0 0 0 1							1. Call is not end-to-end ISDN: further progress information may be available in-band
0 0 0 0 0 1 0							2. Destination address is non-ISDN
0 0 0 0 0 1 1							3. Origination address is non-ISDN
0 0 0 0 1 0 0							4. Call has returned to the ISDN
0 0 0 1 0 0 0							8. In-band information or appropriate pattern now available

All other values are reserved.

NOTE: The use of the different progress descriptions is further explained in Annex I.

4.5.23 Repeat indicator

ETSI NOTE: This information element is not used in ISDNs conforming to this ETS.

4.5.24 Restart indicator

The purpose of the Restart indicator information element is to identify the class of the facility (i.e. channel or interface) to be restarted.

The Restart indicator information element is coded as shown in figure 4.32 and table 4.23. The maximum length of this information element is three octets.

8	7	6	5	4	3	2	1	Octet
0	1	1	1	1	0	0	1	1
Restart indicator Information element identifier								
Length of the restart indicator contents								2
1 ext	0	0	0	0	Class			3

Figure 4.32: Restart indicator information element

Table 4.23: Restart indicator information element

Class (octet 3)

Bits

3 2 1

0 0 0

Indicated channels (NOTE 1)

1 1 0

Single interface (NOTE 2)

1 1 1

All interfaces (NOTE 2)

All other values are reserved.

NOTE 1: The Channel identification information element must be included and indicates which channels are to be restarted.

NOTE 2: If non-associated signalling is used, the Channel identification information element must be included to indicate the interface to be restarted if it is other than the one on which the D-channel is present. Since this ETS applies only to associated signalling, the Channel identification information element shall not be included to indicate the interface to be restarted. As a consequence, either code point can be used to perform the same function.

4.5.25 Segmented message

The purpose of the Segmented message information element is to indicate that the transmission in which it appears is part of a segmented message, in addition to the use of message type SEGMENT. When included in a message segment, it appears directly after the Message type information element (see Annex K).

The segmented message information element is coded as shown in figure 4.33 and table 4.24.

8	7	6	5	4	3	2	1	Octet
0	0	0	0	0	0	0	0	1
Segmented message Information element identifier								
Length of the segmented message contents								2
First segment indicat	Number of segments remaining							3
0	Segmented message type							4

Figure 4.33: Segmented message information element

Table 4.24: Segmented message information element

First segment indicator (octet 3)

Bit
 8
 0 Subsequent segment to first segment
 1 First segment of segmented message

Number of segments remaining (octet 3)

Binary number indicating the number or remaining segments within the message to be sent.

Segmented message type (octet 4)

Type of message being segmented coded as per §4.4.

NOTE: Bit 8 is reserved for possible future use as an extension bit.

4.5.26 Sending complete

The purpose of the Sending complete information element is to optionally indicate completion of called party number, see §§5.1.1, 5.1.3, 5.2.1 and 5.2.4.

It is a single octet information element coded as shown in figure 4.34.

8	7	6	5	4	3	2	1	Octet
1	0	1	0	0	0	0	1	1
Sending complete Information element identifier								

Figure 4.34: Sending complete information element

4.5.27 Signal

The purpose of the Signal information element is to allow the network to optionally convey information to a user regarding tones and alerting signals. (See §§7 and 8.)

The Signal information element is coded as shown in figure 4.35 and table 4.25. The length of this information element is 3 octets.

The Signal information element may be repeated in a message.

Bits	8	7	6	5	4	3	2	1	Octet
	0	0	1	1	0	1	0	0	1
Signal Information element identifier									
	0	0	0	0	0	0	0	1	2
Length of signal contents									
	Signal value								3

Figure 4.35: Signal information element

Table 4.25: Signal information element

Signal value (octet 3)								
Bits								
8	7	6	5	4	3	2	1	
0	0	0	0	0	0	0	0	dial tone on
0	0	0	0	0	0	0	1	ring back tone on
0	0	0	0	0	0	1	0	intercept tone on
0	0	0	0	0	0	1	1	network congestion tone on
0	0	0	0	0	1	0	0	busy tone on
0	0	0	0	0	1	0	1	confirm tone on
0	0	0	0	0	1	1	0	answer tone on
0	0	0	0	0	1	1	1	call waiting tone on
0	0	0	0	1	0	0	0	off-hook warning tone on
0	0	1	1	1	1	1	1	tones off
0	1	0	0	0	0	0	0	alerting on - pattern 0 (NOTE)
0	1	0	0	0	0	0	1	alerting on - pattern 1 (NOTE)
0	1	0	0	0	0	1	0	alerting on - pattern 2 (NOTE)
0	1	0	0	0	0	1	1	alerting on - pattern 3 (NOTE)
0	1	0	0	0	1	0	0	alerting on - pattern 4 (NOTE)
0	1	0	0	0	1	0	1	alerting on - pattern 5 (NOTE)
0	1	0	0	0	1	1	0	alerting on - pattern 6 (NOTE)
0	1	0	0	0	1	1	1	alerting on - pattern 7 (NOTE)
0	1	0	0	1	1	1	1	alerting off
All other values reserved.								
NOTE: The use of these patterns is network dependent.								

4.5.28 Transit network selection

The purpose of the Transit network selection information element is to identify one requested transit network. The Transit network selection information element may be repeated in a message to select a sequence of transit networks through which a call must pass. See Annex C.

The Transit network selection information element is coded as shown in figure 4.36 and table 4.26. The default maximum length of this information element is network dependent.

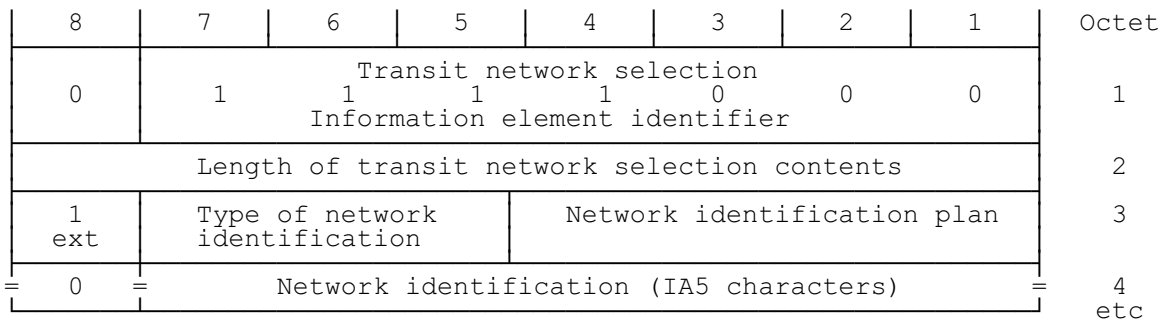

Figure 4.36: Transit network selection information element

Table 4.26: Transit network selection information element

Type of network identification (octet 3)

Bits	
<u>7 6 5</u>	
0 0 0	user specified
0 1 0	national network identification
0 1 1	international network identification

All other values are reserved.

Network identification plan (octet 3)

Bits	
<u>4 3 2 1</u>	
0 0 0 0	unknown
0 0 0 1	Carrier Identification Code (NOTE)
0 0 1 1	data network identification code (CCITT Recommendation X.121)

All other values are reserved.

NOTE: Carrier Identification Codes may be an appropriate method of identifying the network serving the remote user.

Network identification (octet 4)

These IA5 characters are organized according to the network identification plan specified in octet 3.

4.5.29 User-user

The purpose of the User-user information element is to convey information between ISDN users. This information is not interpreted by the network, but rather is carried transparently and delivered to the remote user(s).

The User-user information element is coded as shown in figure 4.37 and table 4.27. There are no restrictions on content of the user information field.

In SETUP, ALTERING, CONNECT, DISCONNECT, RELEASE and RELEASE COMPLETE messages, the User-user information element has a network dependent maximum size of 35 or 131 octets. The evolution to a single maximum value is the long term objective; the exact maximum value is the subject of further study.

In USER INFORMATION messages sent in association with a circuit-mode connection, the User-user information element has a network dependent maximum size of 35 or 131 octets. For USER INFORMATION messages sent in a temporary or permanent user-user signalling connection, the user information field contained inside this information element has a maximum size equal to the maximum size of messages defined in §3, that is 260 Octets.

NOTE: The User-user information element is transported transparently by an ISDN between a call originating entity, e.g. a calling user and the addressed entity, e.g. a remote user or a high layer function network node addressed by the call originating entity.

8	7	6	5	4	3	2	1	Octet
0	1	1	1	1	1	1	0	1
User-user Information element identifier								
Length of user-user contents								2
Protocol discriminator								3
User Information								4 etc.

Figure 4.37: User-user information element

Table 4.27: User-user information element

Protocol discriminator (octet 3)

Bits

8 7 6 5 4 3 2 1

0 0 0 0 0 0 0 0			User-specific protocol (NOTE 1)
0 0 0 0 0 0 0 1			OSI high layer protocol
0 0 0 0 0 0 1 0			X.244 (NOTE 2)
0 0 0 0 0 0 1 1			Reserved for system management convergence function
0 0 0 0 0 1 0 0			IA5 characters (NOTE 4)
0 0 0 0 0 1 1 1			CCITT Recommendation V.120 rate adaption
0 0 0 0 1 0 0 0			Q.931 (I.451) user-network call control messages
0 0 0 1 0 0 0 0	}		reserved for other network layer or layer 3 protocols, including Recommendation X.25 (NOTE 3)
through	}		
0 0 1 1 1 1 1 1	}		
0 1 0 0 0 0 0 0	}		national use
through	}		
0 1 0 0 0 1 1 1	}		
0 1 0 0 1 0 0 0	}		reserved for ETSI use
through	}		
0 1 0 0 1 1 1 1	}		
0 1 0 1 0 0 0 0	}		reserved for other network layer or layer 3 protocols, including Recommendation X.25 (NOTE 3)
through	}		
1 1 1 1 1 1 1 0	}		

All other values are reserved.

NOTE 1: The user information is structured according to user needs.

NOTE 2: The user information is structured according to Recommendation X.244 which specifies the structure of X.25 call user data.

NOTE 3: These values are reserved to discriminate these protocol discriminators from the first octet of a X.25 packet including general format identifier.

NOTE 4: The user information consists of IA5 characters.

4.6 Supplementary services information elements

4.6.1 Date/time

The purpose of the Date/time information element is to provide the date and time to the user. It indicates the point in time when the message has been generated by the network.

NOTE: It is a network dependent matter whether The time indicated is local time or Coordinated Universal Time (UTC) and which calendar is used for referencing the date.

The Date/time information element is coded as shown in figure 4.38.

Octets 3-8 are binary coded (bit 1 being the least significant bit).

8	7	6	5	4	3	2	1	Octet
0	0	1	0	1	0	0	1	1
Date/time Information element identifier								
Length of the date/time contents								2
Year								3
Month								4
Day								5
Hour								6
Minute								7
Second								8*

Figure 4.38: Date/time information element

4.6.2 Facility

The generic structure and codepoints for the Facility information element are defined in Annex P. This section contains only the coding required for procedures described in §7 of this ETS.

The purpose of the Facility information element is to indicate the invocation and operation of supplementary services, identified by the corresponding operation value within the Facility information element. The Facility information element is defined in figures 4.39 to 4.43 and tables 4.28 to 4.33.

NOTE: The generic structure and codepoints for the Facility information element are defined in Recommendation Q.932. This section contains only the coding required for procedures described in §7 of this Recommendation.

The Facility information element may be repeated in a given message.

The maximum length of the Facility information element is application dependent consistent with the maximum length of the message.

8	7	6	5	4	3	2	1	Octet
0	0	0	1	1	1	0	0	1
Facility Information element identifier								
Length of facility contents								2
1 ext	0	0	Service discriminator					3
1 class	0	1 form	Component tag					4
0 Length format	Length of component						5	
Component contents								6

NOTE: The component, comprised of octets 4-6, may be repeated an indefinite number of times within the Facility information element.

Figure 4.39: Facility information element

Table 4.28: Facility information element

Service discriminator (octet 3)

Bits
5 4 3 2 1
1 0 0 0 1 supplementary service applications
All other values are reserved.

Class (octet 4)

Bits
8 7
1 0 context-specific
All other values are reserved.

Form (octet 4)

Bit
6
1 constructor
All other values are reserved.

Component tag (octet 4)

Bits
5 4 3 2 1
0 0 0 0 1 invoke
0 0 0 1 0 return result
0 0 0 1 1 return error
0 0 1 0 0 reject
All other values are reserved.

Length format (octet 5)

Bit
8
0 length of the component length field is on octet
All other values are reserved.

Length of component (octet 5 bits 7-1)

This field indicates the total length of the contents of the component field (i.e. octet 6 and its subparts). It is the binary coding of the number of octets of the component, with bit 1 as the least significant bit (2^0).

Component (octet 6)

The structure of the component field varies, according to the specific component indicated in the component tag field. See remainder of §4.6.2.

Table 4.29: Facility information element

Abstract Syntax Notation 1 (ASN.1) representation of user-user information service components

```

User-User-Service-operations {ccitt recommendation q.931 user-user(1)}
DEFINITIONS ::=
BEGIN

IMPORTS OPERATION, ERROR FROM Functional-Protocol-Notation
    {ccitt recommendation q.932 functional protocol notation}

userUserService OPERATION
    ARGUMENT SEQUENCE {Service, Preferred}

    RESULT
        - The return of a Return_Result PDU is an acknowledgement of a
        - successful outcome of the user_user_service operation

    ERRORS {rejectedByTheNetwork, rejectedByTheUser}

Service ::= [1] IMPLICIT INTEGER {service1 (1),
    service2 (2),
    service3 (3)}

Preferred ::= [2] IMPLICIT BOOLEAN

rejectedByTheNetwork ERROR
    ::= 1
        -- The return of a Return_Error PDU with an error code 1 is an indication
        -- that either the user has not subscribed to this service or that the
        -- requested service is not provided by the network

rejectedByTheUser ERROR
    ::= 2
        -- The return of a Return_Error PDU with an error code 2 is an indication
        -- that requested service is provided by the network but that the user
        -- rejects the service activation

END -- of User-user Service definitions
    
```

NOTE: See CCITT Recommendations X.208 and X.209 for a complete definition of ASN.1.

ETSI NOTE: This notation has been aligned with the ASN.1 notation.

4.6.2.1 Invoke component

The invoke component is used to request the indicated supplementary service.

The invoke component is coded as shown in figure 4.40.

The length of the invoke component is 14 octets.

8	7	6	5	4	3	2	1	Octet
1	0	1	0	0	0	0	1	4 (of Fac.int. element)
class		form		Invoke component tag				
length 0 format	Length of invoke component							5
0	0	0	0	0	0	1	0	6
class		form		Invoke identifier tag				
length 0 format	Length of invoke identifier							6.1
Invoke identifier								6.2 etc.
0	0	0	0	0	0	1	0	6.3
class		form		Operation value tag				
length 0 format	Length of operation value							6.4
Operation value								6.5
Operation-specific fields								6.6 etc.

Figure 4.40: Invoke component within Facility information element

Table 4.30: Invoke component within Facility information element

Class (octets 6 and 6.3)

Bits

8 7

0 0 universal

All other values are reserved.

Form (octets 6 and 6.3)

Bit

6

0 primitive

All other values are reserved.

Length format (octets 6.1 and 6.4)

Bit

8

0 length is one octet

All other values are reserved.

Length of invoke identifier (octet 6.1 bits 7-1)

This field indicates the total length of the contents of invoke identifier field (i.e. octet 6.2). It is the binary coding of the number of the octets of the invoke identifier, with bit 1 as the least significant bit (2^0).

Invoke identifier (octet 6.2)

This field contains a unique identification used to identify the request of a supplementary service and is used to correlate this request with the corresponding replies.

Length of operation value (octet 6.4 bits 7-1)

This field indicates the total length of the contents of the operation value field (i.e. octet 6.5). It is the binary coding of the number of octets of the operation value, with bit 1 as the least significant bit (2^0). At the present time only single octet operation values have been defined.

Operation value (octet 6.5)

Bits

8 7 6 5 4 3 2 1

0 0 0 0 0 0 0 1 user-user information.

All other values are reserved.

Operation-specific fields (octets 6.6, etc)

Each operation value may have a number of associated fields. These fields vary from operation to operation value. See remainder of §4.6.2.1.

4.6.2.1.1 Operation-specific fields for user-user information supplementary service.

The user-user information supplementary service operation-specific fields within the invoke component of the Facility information element are used to indicate details of the requested user-user information supplementary service.

These fields are coded as shown in figure 4.41 and table 4.31.

The length of these fields is 6 octets.

8	7	6	5	4	3	2	1	Octet	
0	0	1	1	0	0	0	0	6.6 (of Fac.inf. element)	
class		form	Sequence tag						
length 0 format	Length of sequence tag							6.7	
1	0	0	0	0	0	0	1	6.8	
class		form	Service tag						
length 0 format	Length of service							6.8.1	
Service									6.8.2
1	0	0	0	0	0	1	0	6.8.3	
class		form	Preferred tag						
0	0	0	0	0	0	0	1	6.8.4	
length format	Length of preferred								
Preferred									6.8.5

Figure 4.41: Facility information element: invoke component: operation-specific fields for user-user information supplementary service

Table 4.31: Facility information element: invoke component: operation-specific fields for user-user information supplementary service

Class (octets 6.6, 6.8 and 6.8.3)

Bits

8 7

0 0 universal

1 0 context-specific

All other values are reserved.

Form (octets 6.6, 6.8 and 6.8.3)

Bit

6

0 primitive

1 constructor

Length format (octets 6.7, 6.8.1 and 6.8.4)

Bit

8

0 length is one octet

All other values are reserved.

Length of sequence (octet 6 bits 7-1)

This field indicates the total length of the following sequence of fields (i.e. octet 6.8 and its subparts). It is the binary coding of the number of octets of the service, with bit 1 as the least significant (2^0).

Length of service (octet 6.8.1 bits 7-1)

This field indicates the total length of the contents of the service field (i.e. octet 6.8.2). It is the binary coding of the number of octets of the service, with bit 1 as the least significant bit (2^0). At the present time, only single octet service values have been defined.

Service (octet 6.8.2)

Bits

8 7 6 5 4 3 2 1

0 0 0 0 0 0 0 0 Service 1

0 0 0 0 0 0 1 0 Service 2

0 0 0 0 0 0 1 1 Service 3

All other values are reserved.

NOTE: The meaning of user-user information supplementary services 1, 2 and 3 are defined in CCITT Recommendation I.257A.

Length of preferred (octet 6.8.4)

This field indicates the total length of the preferred field (i.e. octet 6.8.5). It is the binary coding of the number of octets of the preferred field, with bit 1 as the least significant field (2^0). At the present time, only single octet preferred values have been defined.

Preferred octet (6.8.5)

Bits

8 7 6 5 4 3 2 1

0 0 0 0 0 0 0 0 False (service is required)

0 0 0 0 0 0 0 1 True (service is preferred)

All other values are reserved.

4.6.2.2.2 Return result component

The return result component enables the performing entity to provide a positive reply to a successfully performed operation to the invoking entity.

The return result component is coded as shown in figure 4.42.

8	7	6	5	4	3	2	1	Octet
1	0	1	0	0	0	1	0	4 (of Fac.inf. element)
class		form	Return result component tag					
length 0 format	Length of return result component							5
0	0	0	0	0	0	1	0	6
class		form	Invoke identifier tag					
length 0 format	Length of invoke identifier							6.1
Invoke identifier								6.2 etc.

Figure 4.42: Return result component within facility information element

Table 4.32: Return result component within facility information element

Class (octet 6)

Bits

8 7
 0 0 universal

All other values are reserved.

Form (octet 6)

Bit

6
 0 primitive

All other values are reserved.

Length format (octet 6.1)

Bit

8
 0 length is one octet

All other values are reserved.

Length of invoke identifier (octet 6.1 bits 7-1)

This field indicates the total length of the contents of invoke identifier field (i.e. octet 6.2). It is the binary coding of the number of octets of the invoke identifier, with bit 1 as the least significant bit (2⁰).

Invoke identifier (octet 6.2)

This field is used to correlate the positive response to the supplementary service requested by the invoking entity.

4.6.2.3 Return error component

The return error component enables the performing entity to return the negative reply to the invoking entity.

The return error component is coded as shown in figure 4.43.

8	7	6	5	4	3	2	1	Octet
1	0	1	0	0	0	1	1	4 (of Fac.inf. element)
class		form		Return error component tag				
length 0 format	Length of return error component							5
0	0	0	0	0	0	1	0	6
class		form		Invoke identifier tag				
length 0 format	Length of invoke identifier							6.1
Invoke identifier								6.2 etc.
0	0	0	0	0	0	1	0	6.3
class		form		Error value tag				
length 0 format	Length of error value							6.4
0	0	0	0	0	0	X	X	6.5
error value								

Figure 4.43: Return error component within facility information element

Table 4.33: Return error component within facility information element

Class (octet 6 and 6.3)

Bits
8 7
0 0 universal
All other values are reserved.

Form (octet 6 and 6.3)

Bit
6
0 primitive
All other values are reserved.

Length format (octet 6.1 and 6.4)

Bit
8
0 length is one octet
All other values are reserved.

Length of invoke identifier (octet 6.1)

This field indicates the total length of the contents of invoke identifier field (i.e. octet 6.2). It is the binary coding of the number of the octets of the invoke identifier, with bit 1 as the least significant bit (2^0).

Invoke identifier (octet 6.2)

This field is used to correlate the negative response to the supplementary service requested by the invoking entity.

Length of error value (octet 6.4 bits 7-1)

This field indicates the total length of the contents of the error value field (i.e. octet 6.5). It is the binary coding of the number of octets of the service, with bit 1 as the least significant bit (2^0). At the present time only a single octet error octet value has been defined.

Error value (octet 6.5)

Bits
8 7 6 5 4 3 2 1
0 0 0 0 0 0 0 1 not supported user not subscribed (or not provided by the network)
0 0 0 0 0 0 1 0 provided by the network but rejected by the called user
All other values are reserved.

4.6.3 Feature activation

ETSI NOTE: This information element is not supported in ISDNs conforming to this ETS.

4.6.4 Feature indication

ETSI NOTE: This information element is not supported in ISDNs conforming to this ETS.

4.6.5 Switchhook

ETSI NOTE: This information element is not supported in ISDNs conforming to this ETS.

4.7 Information elements for packet communications

The information elements to be used in the support of packet communications are described in ETS 300 007.

5 Circuit switched call control procedures

The call states referred to in this section cover the states perceived by the network, states perceived by the user and states which are common to both user and network. Unless specifically qualified, all states described in the following text should be understood as common (see §§2.1.1 and 2.1.2 for user and network call states respectively). An overview diagram for call states is given in figures A-2/Q.931 and A-3/Q.931 (Annex A).

Detailed specification and description language (SDL) diagrams for the procedures specified in this section are contained in ETS 300 102-2 figures A-4/Q.931 through A-6/Q.931. When there is an ambiguity in the narrative text, the SDL diagrams in ETS 300 102-2 figures A-4/Q.931 through A-6/Q.931 should be used to resolve conflict. Where the text and the SDL are in disagreement, the text should be used as the prime source.

NOTE: This section describes the sequence of messages associated with the control of circuit switched connections. Optional extensions to this basic protocol and exceptions that apply in the case of packet mode connections or supplementary services are described elsewhere in this ETS, in ETS 300 007 or in ETS 300 122 and ETSI T/S 46-32B. Annex D also contains optional extensions to the basic call establishment procedures defined in §5 for symmetric signalling. Future enhancements to the procedures defined in §5 are being considered to obtain symmetric basic call control procedures that can be used, for example, in PABX-to-PABX applications.

ETSI Requirement: ETSI T/S 49-30 also contains information for the ISPBX-to-ISPBX basic call control in the context of private network applications.

All messages in this ETS may contain two types of information elements, functional and/or stimulus. Functional information elements are characterized as requiring a degree of intelligent processing by the terminal in either their generation or analysis. Stimulus information elements, on the other hand, are either generated as a result of single event at the user/terminal interface or contain a basic instruction from the network to be executed by the terminal. As a general principle, all the messages sent by the network to the user may contain a Display information element whose contents may be displayed by the terminal; the content of this information element shall be network dependent.

NOTE: Keypad facility information elements shall only be conveyed in the direction user-to-network. Display information elements shall be conveyed in the direction network-to-user.

ETSI Requirement: Keypad facility information elements can be conveyed only in order to provide information related to the provision of supplementary services.

In addition to the messages exchanged as described in the following sections, INFORMATION messages for call control may be sent by the user or by the network only after the first response to a SETUP message has been sent or received, and before clearing of the call reference is initiated. An INFORMATION message received in the Release Request state may be ignored.

In order to accommodate the transfer of layer 3 messages which exceed the data link layer maximum frame length (i.e. defined in ETS 300 125), a method of message segmentation and reassembly may optionally be implemented as described in Annex K. Message segmentation shall only be used where all the information comprising the unsegmented message is available at the time of sending the first message segment.

NOTE: Message segmentation is not used to replace existing procedures where information is yet to be provided by call control, e.g. digit by digit sending in overlap mode, although this may be used in addition. Message segmentation shall only be used when the message length exceeds the value of the N201 parameter defined in ETS 300 125.

5.1 Call establishment at the originating interface

Before these procedures are invoked, a reliable data link connection must be established between the user (TE/NT2) and the network. All layer 3 messages shall be sent to the data link layer using a DL-DATA-REQUEST primitive. The data link services described in ETS 300 125 are assumed.

5.1.1 Call request

A user initiates call establishment by transferring a SETUP message across the user-network interface. Following the transmission of the SETUP message, the call shall be considered by the user to be in the Call Initiated state. The message shall always contain a call reference, selected according to the procedures given in §4.3. In selecting a call reference, the dummy call reference value shall not be used. The Bearer capability information element is mandatory in the SETUP message, even in the case of overlap sending.

ETSI requirement: The dummy call reference value as defined in CCITT Recommendation Q.931 is not supported in association with the basic call.

If the user knows all appropriate channels controlled by the D-channel are in use, it shall not transfer a SETUP message across the user-network interface. If the user does not monitor the status of channels in use, it may send a SETUP message during an all channels busy condition. In this case the network returns a RELEASE COMPLETE message with cause #34, "no circuit/channel available".

Furthermore the SETUP message may also contain all or part of the call information (i.e. address and facility requests) necessary for call establishment depending on whether en-bloc or overlap procedures are being used respectively (see §5.1.3).

If en-bloc sending is used, the SETUP message shall contain all the information required by the network to process the call, and, in particular, the called party address information if present, is contained as follows:

- a) in the Called party number information element possibly completed by the Called party subaddress information element. ;or,
- b) the Keypad facility information element which may also be used to convey other call information.

NOTE: The support of (a) is mandatory in all networks. Whether the support of (b) is mandatory or optional requires further study.

ETSI requirement: If en-bloc sending is used, the SETUP message may contain the sending complete indication (i.e. either the Sending complete information element or the "#" character within the Called party number information element). It is mandatory for the network to recognize the Sending complete information element.

For overlap sending, see §5.1.3.

ETSI requirement: Called party subaddress information, if present, shall be given in the Called party subaddress information element and, in the case of overlap sending, shall only be sent in the SETUP message.

5.1.2 B-channel selection - originating

In the SETUP message, the user will indicate one of the following:

- a) channel is indicated, no acceptable alternative; or,
- b) channel is indicated, any alternative is acceptable; or,
- c) any channel is acceptable.

If no indication is included, alternative c) is assumed. In cases a) and b), if the indicated channel is available, the network selects it for the call.

In case b), if the network cannot grant the preferred channel, it selects any other available B-channel associated with the D-channel. In case c), the network selects any available B-channel associated with the D-channel.

ETSI requirement: It is recommended that TEs connected to the ISDN basic access should use alternative c) for basic circuit-switched call control unless the TE is already using a given B-channel.

The selected B-channel is indicated in the Channel identification information element coded as "channel is indicated, no acceptable alternative", in the first message returned by the network in response to the SETUP message (i.e. a SETUP ACKNOWLEDGE or CALL PROCEEDING message). After transmitting this message, the network shall activate the B-channel connection.

The user need not attach until receiving a CALL PROCEEDING/SETUP ACKNOWLEDGE/PROGRESS/ALERTING message with the progress indicator #8 "in-band information or appropriate pattern is now available" or progress indicator #1 "call is not end-to-end ISDN; further call progress information may be available in-band". Prior to this time, the network cannot assume that the user has attached to the B-channel. After this time, the user shall be connected to the B-channel, provided the equipment does not generate local tone. Upon receipt of the CONNECT message the user shall attach to the B-channel (if it has not already done so).

In case a) if the specified channel is not available, and in cases b) and c) if no channel is available, a RELEASE COMPLETE message with cause #44 "requested circuit/channel not available" or #34 "no circuit/channel available", respectively, is sent by the network as described in §5.3.

5.1.3 Overlap sending

If overlap sending is used, the SETUP message contains either:

- a) no called number information; or,
- b) incomplete called number information; or,
- c) called number information which the network cannot determine to be complete.

On receipt of such a SETUP message, the network starts timer T302 (the value of timer T302 is specified in §9.1), sends a SETUP ACKNOWLEDGE message to the user, and enters the Overlap Sending state. In case (a), the network will return dial tone, if required by the tone option (see the following ETSI Requirement). In this case it may include progress indicator #8 "in-band information or appropriate pattern is now available" in the SETUP ACKNOWLEDGE message.

ETSI requirement: The tone option should be interpreted as the need to return dial tone in the case where the Bearer capability information element indicates an appropriate bearer capability, e.g. "3.1 kHz audio" or "speech". When the tone option is applied, the user equipment shall attach to the B-channel on receipt of the SETUP ACKNOWLEDGE message.

NOTE: Some networks which systematically provide the conventional telephone dial tone will not generate the progress indicator when providing the dial tone.

When the SETUP ACKNOWLEDGE message is received, the user enters the Overlap Sending state and optionally starts timer T304 (the value of timer T304 is specified in §9.2).

After receiving the SETUP ACKNOWLEDGE message, the user sends the remainder of the call information (if any) in one or more INFORMATION messages.

The called party number information shall be provided by the user as follows:

- a) in the Called party number information element. ;or,
- b) in the Keypad facility information element, exclusively.

The called party number must be sent in a unique way.

NOTE 1: The support of (a) is mandatory in all networks. Whether the support of (b) is mandatory or optional requires further study.

ETSI requirement: On receiving the first INFORMATION message, the network shall remove dial tone if it had been applied as described above. Removal of dial tone shall not be accompanied by any Progress indicator information element.

NOTE 2: Besides the possible Called party number information element (conveyed by method a) or b) as described above), the INFORMATION messages may contain additional call information, (i.e. for supplementary services). The interpretation of the contents of Keypad facility information elements is network specific, and in accordance with the dialling plan provided to that user. It should be noted that The user shall transfer all the additional call information (contained within the Keypad facility information element) before the network determines that the called party number (contained within the Called party number information element or the Keypad facility information element) is complete, and terminates the overlap sending procedure using the CALL PROCEEDING message as recommended in §5.1.5.2.

If, for symmetry purposes, the user employs timer T304, the user restarts timer T304 when each INFORMATION message is sent.

The call information in the message that completes the information sending may contain a "sending complete" indication (i.e. the # character or as a network option, the Sending complete information element) appropriate to the dialling plan being used. The network shall restart timer T302 on the receipt of every INFORMATION message not containing a sending complete indication.

5.1.4 Invalid call information

If, following the receipt of a SETUP message or during overlap sending, the network determines that the call information received from the user is invalid (e.g. invalid number), then the network shall initiate call clearing as defined in §5.3 with a cause such as one of the following:

- a) #1 "unassigned (unallocated) number"
- b) #3 "no route to destination"
- c) #22 "number changed"
- d) #28 "invalid number format (incomplete number)".

5.1.5 Call proceeding

5.1.5.1 Call proceeding, en-bloc sending

If en-bloc sending is used (i.e. the network can determine that the SETUP message contains all the information required from the user to establish the call) and if the network can determine that access to the requested service is authorized and available, the network shall: send a CALL PROCEEDING message to the user to acknowledge the SETUP message and to indicate that the call is being processed; and enter the Outgoing Call Proceeding state. When the user receives the CALL PROCEEDING message, the user shall enter the Outgoing Call Proceeding state.

Similarly, if the network determines that a requested service is not authorized or is not available, the network shall initiate call clearing in accordance with §5.3 with one of the following causes:

- a) #57 "bearer capability not authorized".
- b) #58 "bearer capability not presently available".
- c) #63 "service or option not available, unspecified", or
- d) #65 "bearer service not implemented".

NOTE: If a supplementary service is not authorized and is not available, the procedure to be used is defined in the supplementary service control procedures.

5.1.5.2 Call proceeding, overlap sending

If overlap sending is used following the occurrence of one of these conditions:

- a) the receipt by the network of a sending complete indication which the network understands; or
- b) analysis by the network that all call information necessary to effect call establishment has been received;

and if the network can determine that access to the requested service is authorized and available, the network shall: send a CALL PROCEEDING message to the user; stop timer T302; and enter the Outgoing Call Proceeding state.

Similarly, if the network determines that a requested service is not authorized or is not available, the network shall initiate call clearing in accordance with §5.3 with one of the following causes:

- a) #57 "bearer capability not authorized".
- b) #58 "bearer capability not available".
- c) #63 "service or option not available, unspecified", or
- d) #65 "bearer service not implemented".

NOTE 1: The CALL PROCEEDING message is sent to indicate that the requested call establishment has been initiated, and no more call establishment information will be accepted.

NOTE 2: If a supplementary service is not authorized or is not available, the procedure to be used is defined in the supplementary service control procedures.

When the user receives the CALL PROCEEDING message, the user shall enter the Outgoing Call Proceeding state. If, for symmetry purposes, the calling user employs timer T304, the user shall stop timer T304 when the CALL PROCEEDING message is received.

An alerting or connect indication received from the called party will stop timer T302 and cause an ALERTING or CONNECT message respectively to be sent to the calling user. No CALL PROCEEDING message shall be sent by the network. If, for symmetry purposes, the calling user employs timer T304, the user shall stop timer T304 on receiving the ALERTING or CONNECT message.

At the expiration of timer T302, the network shall:

- a) initiate call clearing in accordance with §5.3 with cause #28 "invalid number format (incomplete number)" sent to the calling user and with cause #102 "recovery on timer expiry" sent towards the called user, if the network determines that the call information is definitely incomplete; otherwise,

- b) send a CALL PROCEEDING message and enter the Outgoing Call Proceeding state.

If, for symmetry purposes, the calling user employs timer T304 then on expiry of T304, the user shall initiate call clearing in accordance with §5.3 with cause #102 "recovery on timer expiry".

5.1.6 Notification of interworking at the originating interface.

During call establishment, the call may leave an ISDN environment; e.g. because of interworking with another network, with a non-ISDN user, or with non-ISDN equipment within the calling or called user's premises. When such situations occur, a Progress indicator information element shall be returned to the calling user either:

- a) in an appropriate call control message when a state change is required (SETUP ACKNOWLEDGE, CALL PROCEEDING, ALERTING or CONNECT); or,
- b) in the PROGRESS message when no state change is appropriate.

One of the following progress description values shall be included in the Progress indicator information element in the message sent to the user (for further information, see Annex I):

- 1) #1 "call is not end-to-end ISDN; further call progress information may be available in-band".
- 2) #2 "destination address is non-ISDN".
- 3) #4 "call has returned to the ISDN". Call is now end-to-end ISDN.

If the Progress indicator information element is included in a call control message, the procedures as described in the rest of §5.1 apply. If the Progress indicator information element is included in the PROGRESS message, no state change will occur but any supervisory timers shall be stopped. In both cases, if indicated by the Progress indicator information element, the user shall connect to (if not connected already) and then monitor the B-channel for further in-band information.

ETSI Requirement: If the Progress indicator information element is included in the PROGRESS message, ISDNs conforming to this ETS will stop any supervisory timer except network timer T302.

If the interface at which the progress indication originates is the point at which a call enters the ISDN environment from a non-ISDN environment, one or more of the following Progress indicator information elements shall be included in the SETUP message sent to the network:

- a) #1 "call is not end-to-end ISDN; further call progress information may available in-band".
- b) #3 "origination address is non-ISDN".

5.1.7 Call confirmation indication

Upon receiving an indication that user alerting has been initiated at the called address, the network shall: send an ALERTING message across the user-network interface of the calling address; and enter the Call Delivered state. When the user receives the ALERTING message, the user: may begin an internally-generated alerting indication; and shall enter the Call Delivered state.

ETSI requirement: In addition to the sending of the ALERTING message, ISDNs conforming to this ETS will provide in-band ringing tone to the calling user in the case where the Bearer capability information element indicates "3.1 kHz audio" or "speech".

ETSI requirement: When the user receives the ALERTING message, the user shall:

- a) attach to the B-channel (if it has not already done so), provided the requested bearer capability is "3.1 kHz audio" or "speech", and provided the equipment does not generate local tone; or,

- b) cause initiation of the user equipment generated alerting condition beginning an internally-generated alerting indication.

5.1.8 Call connected

Upon receiving an indication that the call has been accepted, the network shall: send a CONNECT message across the user-network interface to the calling user; and enter the Active state.

This message indicates to the calling user that a connection has been established through the network and stops a possible local indication of alerting.

ETSI requirement: Upon receiving an indication that the call has been accepted, the network shall remove any applied ringing tone.

On receipt of the CONNECT message, the calling user: shall stop any user-generated alerting indications; may optionally send a CONNECT ACKNOWLEDGE message; and shall enter the Active state. The network shall not take any action on receipt of a CONNECT ACKNOWLEDGE message when it perceives the call to be in the Active state.

5.1.9 Call rejection

Upon receiving an indication that the network or the called user is unable to accept the call, the network shall initiate call clearing at the originating user-network interface as described in §5.3, using the cause provided by the terminating network or the called user.

5.1.10 Transit network selection

When the transit network selection information element is present, the call shall be processed according to Annex C.

5.2 Call establishment at the destination interface

This procedure assumes that a data link connection providing services described in ETS 300 125 may not exist before the first layer 3 message (SETUP) is transferred across the interface. However, reliable data link connections must be established by each of the users (terminals and/or NT2s) at the interface before they respond to the SETUP message.

Permanent Data link connections may be established by the TA, TE or NT2 as soon as a TEI is assigned (either locally or by automatic assignment procedure), and may be retained indefinitely. are not precluded, and This may be recommended as a national network option.

The SETUP message offered on a point-to point data link shall be delivered to layer 2 using a DL-DATA-REQUEST primitive. No use shall be made of the DL-UNIT DATA-REQUEST primitive other than for operation using the broadcast capability of the data link layer.

The call reference contained in all messages exchanged across the user-network interface shall contain the call reference value specified in the SETUP message delivered by the network. In selecting a call reference, the dummy call reference value shall not be used.

5.2.1 Incoming call

The network will indicate the arrival of a call at the user-network interface by transferring a SETUP message across the interface. This message is sent if the network can select an idle B-channel. In some circumstances (e.g. provision of other bearer services §6), the SETUP message may also be sent when no B-channel is idle. The number of calls presented in these circumstances may be limited.

In addition to the mandatory information elements, the SETUP message may include, as required, the information elements described in §3.1.16 (e.g. display, low layer compatibility).

If a multipoint terminal configuration exists at the user-network interface, this message shall be sent using a broadcast capability at the data link layer. In this case, the SETUP message should contain the appropriate part of the called party number as required (e.g. for DDI) and/or sub-address if provided. However, if the network has knowledge that a single-point configuration exists at the interface, a point-to-point data link shall be used to carry the SETUP message. After sending the SETUP message, the network starts timer T303. If the SETUP message was sent via a broadcast data link, timer T312 shall also be started. (The values of timer T303 and T312 are specified in §9.1). The network then enters the Call Present state.

ETSI requirement: The knowledge that a single-point configuration exists may be based on information entered at the time of configuration of the access.

NOTE: Timer T312 is used to supervise the retention of the call reference when the SETUP message was transmitted by a broadcast data link. The value of timer T312 is such that if a network disconnect indication is received during the call establishment phase, it maximises the probability that all responding users will be released prior to the release of the call reference. Refer to §5.3.2 (e) for procedures to be followed on expiry of timer T312.

ETSI requirement: For procedures to be followed on expiry of timer T312 see also §5.2.5.3 (case 1).

If en-bloc receiving is used, the SETUP message shall contain all the information required by the called user to process the call. In this case, the SETUP message may contain the Sending complete information element.

Upon receipt of a SETUP message, the user will enter the Call Present state.

Depending on the contents of the received message, either en-bloc receiving procedure (see §5.2.5.1) or overlap receiving procedure (see §5.2.4) follows. However, if the SETUP message includes the Sending complete information element, en-bloc receiving procedure shall follow. Therefore, those users who support overlap receiving procedure shall recognise the Sending complete information element.

NOTE: Users supporting only the en-bloc receiving procedure need not recognise the Sending complete information element and may directly analyse the received SETUP message on the assumption that all the call information is contained in the message.

If no response to the SETUP message is received by the network before the first expiry of timer T303, the SETUP message will be retransmitted and timers T303 and T312 restarted.

NOTE: In the case of overlap sending within the network, the appropriate part of the called party number as required (e.g. for DDI) may also be conveyed by means of INFORMATION messages to the called user on a point- to-point data link (see §5.2.4).

5.2.2 Compatibility checking

A user receiving a SETUP message shall perform compatibility checking before responding to that SETUP message. Any reference to "user" in §§5.2.3 through 5.2.9 implicitly refers to a compatible user equipment. Annex B defines compatibility checking to be performed by users upon receiving a SETUP message.

When the SETUP message was delivered via a broadcast data link, an incompatible user shall either:

- a) ignore the incoming call; or,
- b) respond by sending a RELEASE COMPLETE message with cause #88 "incompatible destination", and enter the Null state. The network processes this RELEASE COMPLETE message in accordance with §5.2.5.3.

When the SETUP message was delivered via a point-to-point data link, an incompatible user shall respond with a RELEASE COMPLETE message with cause #88 "incompatible destination", and enter the Null state. The network shall process this RELEASE COMPLETE message in accordance with §5.2.5.3.

5.2.3 B-channel selection-destination

5.2.3.1 SETUP message delivered by point-to-point data link

When the SETUP message is delivered by a point-to-point data link, negotiation for the selection of a B-channel will be permitted between the network and the user. Only B-channels controlled by the same D-channel will be the subject of the selection procedure. The selection procedure is as follows:

a) In the SETUP message, the network will indicate one of the following:

[1] channel is indicated, no acceptable alternative; or,

[2] channel is indicated, any alternative is acceptable; or,

[3] any channel is acceptable; or,

[4] no B-channel available.

NOTE: Not all networks will support the "no B-channel available" condition.

ETSI requirement: All ISDNs conforming to this ETS will support the "no B-channel available" condition.

b) In cases 1) and 2), if the indicated channel is acceptable and available, the user selects it for the call.

In case 2), if the user cannot grant the indicated channel, it selects any other available B-channel associated with the D-channel, and identifies that channel in the Channel identification information element as "channel is indicated, no acceptable alternative" in the first message sent in response to the SETUP message.

In case 3), the user selects any available B-channel associated with the D-channel, and identifies that channel in the first message sent in response to the SETUP message.

If in case 1) the B-channel indicated in the first response message is not the channel offered by the network, or in cases 2) and 3) the B-channel indicated in the first response message is unacceptable to the network, it will clear the call by sending a RELEASE message with cause #6 "channel unacceptable" (see §5.3.2 (d)).

In case 4), the user rejects the call by sending a RELEASE COMPLETE message with cause #34 "no circuit/channel available" unless it is able to proceed with the call. The user wishing to re-use a B-channel it has already allocated to another call (e.g. by releasing, or holding it, or by multiplexing packet calls) shall send the appropriate message containing the channel identification information element, coded as "channel is indicated, no alternative acceptable".

c) If no channel identification information element is present in the first response message, the B-channel indicated in the SETUP message will be assumed.

d) When a B-channel has been selected by the user, that channel may be connected by the user.

e) In case 1) if the indicated B-channel is not available, or in cases 2), 3) and 4) if no B-channel is available and the user cannot proceed with the offered call, the user returns a RELEASE COMPLETE message with cause #44 "requested circuit/channel not available" or #34 "no circuit/channel available", respectively, and returns to the Null state.

ETSI Requirement: See §§5.2.4 and 5.2.5 for the appropriate first response to the SETUP message.

5.2.3.2 SETUP message delivered by broadcast data link.

When the SETUP message is delivered by a broadcast data link the channel selection procedure, provided in §5.2.3.1, is not applicable. The network sends a SETUP message with the Channel identification information element indicating one of the following:

- a) channel indicated, no alternative is acceptable; or,
- b) no channel available.

The network starts timers T303 and T312.

In case (a), if the user can accept the call on the indicated channel, the user shall send the appropriate message (see §§5.2.4 and 5.2.5). If the user cannot accept the call on the indicated channel, the user shall send a RELEASE COMPLETE message with cause #44 "requested circuit/channel not available".

The user, in any case, must not connect to the channel until a CONNECT ACKNOWLEDGE message has been received.

In case (b), the user not controlling any channel shall send a RELEASE COMPLETE message with cause #34 "no circuit/channel available". The user wishing to re-use a B-channel it has already allocated to another call (e.g. by releasing, or holding it, or by multiplexing packet calls) shall send the appropriate message containing the Channel identification information element, coded as "channel is indicated, no alternative acceptable".

5.2.4 Overlap receiving

When a user determines that a received SETUP message contains either:

- a) no called number information; or,
- b) incomplete called number information; or,
- c) called number information which the user cannot determine to be complete;

and when the user:

- d) is compatible with other call characteristics (see Annex B); and,
- e) implements overlap receiving;

The user shall: start timer T302; send a SETUP ACKNOWLEDGE message to the network; and enter the Overlap Receiving state.

When the SETUP ACKNOWLEDGE message is received, the network shall: stop timer T303; start timer T304; enter the Overlap Receiving state; and send the remainder of the call information (if any) in one or more INFORMATION messages, starting timer T304 when each INFORMATION message is sent.

The called party number information is provided in the Called party number information element.

The call address information may contain a "sending complete" indication, (e.g. # or, as a network option, the Sending complete information element) appropriate to the dialling plan being used.

ETSI requirement: If a "sending complete" indication is provided, the Sending complete information element shall be used.

NOTE: If the network can determine that sufficient call setup information will be received by the called user by sending the next INFORMATION message, it is recommended that the INFORMATION message contains the Sending complete information element.

The user shall start timer T302 on the receipt of every INFORMATION message not containing a sending complete indication.

Following the receipt of a sending complete indication which the user understands, or the determination that sufficient call information has been received, the user shall stop timer T302, and send a CALL PROCEEDING message to the network. Alternatively, depending on internal events, the user may send an ALERTING or a CONNECT message to the network.

NOTE: The CALL PROCEEDING message in this case will cause the originating exchange to send a CALL PROCEEDING message to the originating user, if not already sent (see also for example CCITT Recommendation Q.699).

At the expiration of timer T302 the user shall:

- a) initiate clearing in accordance with §5.3 with cause #28 "invalid number format (incomplete number)" if it determines that the call information is definitely incomplete; or,
- b) if sufficient call information has been received, send a CALL PROCEEDING, ALERTING or CONNECT message as appropriate.

At the expiration of timer T304 the network initiates call clearing in accordance with §5.3, with cause #28 "invalid number format (incomplete number)" sent to the calling user, and cause #102 "recovery on timer expiry" sent to the called user.

If, following the receipt of a SETUP message or during overlap receiving, the user determines that the received call information is invalid (e.g. invalid called party number), it shall initiate call clearing in accordance with §5.3 with a cause such as one of the following:

- #1 "unassigned (unallocated) number"
- #3 "no route to destination"
- #22 "number changed"
- #28 "invalid number format (incomplete number)".

Upon receipt of the complete call information the user may further perform some compatibility checking functions, as outlined in Annex B.

When the call is offered on a point-to-point data link, only one SETUP ACKNOWLEDGE message can be received in response to the call offering.

When the call is offered to the user on a broadcast data link, multiple SETUP ACKNOWLEDGE messages may be received by the network which shall then complete as many overlap receiving procedures as such SETUP ACKNOWLEDGE messages were received. It is the network's responsibility to limit the number of overlap receiving procedures to be completed for a given call. The default maximum is fixed to eight. Some networks will limit the call offering completion in overlap receiving to single data link and will therefore clear the subsequent responding users after the first SETUP ACKNOWLEDGE message has been received, in accordance with the non-selected user clearing procedures described in §5.2.9.

5.2.5 Call confirmation

5.2.5.1 Response to en-bloc SETUP or completion of overlap receiving

When the user determines that sufficient call setup information has been received and compatibility requirements (see Annex B) have been satisfied, the user responds with either a CALL PROCEEDING,

ALERTING, or CONNECT message (see NOTE 2), and enters the Incoming Call Proceeding, Call Received or Connect Request state, respectively.

NOTE 1: The possibility of alternative responses (e.g. in connection with supplementary services) is for further study.

NOTE 2: A Progress indicator information element may be included in CALL PROCEEDING, ALERTING and CONNECT messages (e.g. when an analogue terminal is connected to an ISDN PABX). The CALL PROCEEDING message may be sent by the user which cannot respond to a SETUP message with an ALERTING, CONNECT, or RELEASE COMPLETE message before expiration of timer T303.

When the SETUP message was delivered via a broadcast data link, an incompatible user shall either:

- a) ignore the incoming call; or,
- b) respond by sending a RELEASE COMPLETE message with cause #88 "incompatible destination", and enter the Null state. The network processes this RELEASE COMPLETE message in accordance with §5.2.5.3.

When the SETUP message was delivered via a point-to-point data link, an incompatible user shall respond by sending a RELEASE COMPLETE message with cause #88 "incompatible destination". The network processes this RELEASE COMPLETE message in accordance with §5.2.5.3.

A busy user which satisfies the compatibility requirements indicated in the SETUP message shall normally respond with a RELEASE COMPLETE message with cause #17 "user busy". The network processes this RELEASE COMPLETE message in accordance with §5.2.5.3.

If the user wishes to refuse the call, a RELEASE COMPLETE message shall be sent with the cause #21 "call rejected", and the user returns to the Null state. The network processes this RELEASE COMPLETE message in accordance with §5.2.5.3.

5.2.5.2 Receipt of CALL PROCEEDING and ALERTING

When the SETUP message is delivered on a broadcast data link, the network shall maintain a state machine that tracks the overall progression of the incoming call. The network shall also maintain an associated call state for each responding user as determined by the data link on which a message is received.

Upon receipt of the first CALL PROCEEDING message from a user (assuming no other user has previously responded with an ALERTING or CONNECT message when the SETUP message has been delivered on a broadcast data link), the network shall: stop timer T303 (or, in the case of overlap receiving, timer T304 for that user); start timer T310; and enter the Incoming Call Proceeding state.

When the SETUP message has been delivered on a broadcast data link, the network shall (at a minimum) associate the Incoming Call Proceeding state with each called user that sends a CALL PROCEEDING message as a first response to the broadcast SETUP message prior to expiration of timer T312. Actions to be taken when a user sends a first response to an incoming call after the expiration of timer T312 are described in §5.2.5.4. Timer T310 shall not be restarted.

Upon receipt of the first ALERTING message from a user (assuming no other user has previously responded with a CONNECT message when the SETUP message has been delivered on a broadcast data link), the network shall: stop timer T304 for that user (in the case of overlap receiving); stop timer T303 or T310 (if running); start timer T301 (unless another internal alerting supervision function exists; e.g. incorporated in call control); enter the Call Received state; and send a corresponding ALERTING message to the calling user.

When the SETUP message has been delivered on broadcast data link, the network shall (at a minimum) associate the Call Received state with each called user that sends an ALERTING message either as a first

response to the broadcast SETUP message or following a CALL PROCEEDING message. Timer T301 shall not be restarted.

5.2.5.3 Called user clearing during incoming call establishment

If the SETUP message has been delivered on a point-to-point data link and a RELEASE COMPLETE or DISCONNECT message is received before a CONNECT message has been received, the network shall stop timer T303, T304, T310 or T301 (if running); continue to clear the user as described in §5.3.3; and clear the call to the calling user with the cause received in the RELEASE COMPLETE or DISCONNECT message.

If the SETUP message has been delivered on a broadcast data link and a RELEASE COMPLETE message is received whilst timer T303 is running, the message cause shall be retained by the network. If timer T303 expires (i.e. if no valid message such as SETUP ACKNOWLEDGE, CALL PROCEEDING, ALERTING or CONNECT has been received) the cause previously retained when a RELEASE COMPLETE message was received is sent back to the calling user in a DISCONNECT message and the network shall enter the Call Abort state. When multiple RELEASE COMPLETE messages are received with different causes, the network shall:

- a) ignore any cause #88 "incompatible destination"; and,
- b) give preference to the following causes (if received) in the order listed below:
(highest) #17 "user busy";
#21 "call rejected";
- c) any other received cause may also be included in the clearing message sent to the originating user (see §5.3).

If the SETUP message has been delivered on a broadcast data link and a user which has previously sent a SETUP ACKNOWLEDGE, CALL PROCEEDING or ALERTING message sends a DISCONNECT message to the network, the actions taken by the network depend on whether timer T312 is running and whether other called users have responded to the SETUP message.

Case 1: DISCONNECT received prior to expiry of timer T312.

If timer T312 is running and the network receives a DISCONNECT message after having received a SETUP ACKNOWLEDGE, CALL PROCEEDING or ALERTING message from a called user (but before receiving a CONNECT message), timer T312, as well as timer T310 or T301 (if running), should continue to run. The network shall retain the cause in the DISCONNECT message and shall continue to clear the user as described in §5.3.3. The network shall stop timer T304 (if running) for this user.

Upon expiration of timer T312, if either:

- a) no other users have responded to the incoming call; or,
- b) all users that have responded to the incoming call have been cleared or are in the process of being cleared:

the network shall stop timer T310 or T301 (if running) and shall clear the call to the calling user. If an ALERTING message has been received, the cause sent to the calling user shall be a cause received from the called user, giving preference to (in order of priority): #21 "call rejected"; any other cause sent by a called user. If only SETUP ACKNOWLEDGE or CALL PROCEEDING messages have been received, the cause sent to the calling user shall be a cause received from the called user, giving preference to (in order of priority): #17 "user busy"; #21 "call rejected"; any other cause sent by a called user.

Case 2: DISCONNECT received after expiry of timer T312.

If timer T312 has expired and the network receives a DISCONNECT message from the called user after having received a SETUP ACKNOWLEDGE, CALL PROCEEDING or ALERTING message (but before

receiving a CONNECT message), the network shall continue to clear the user as described in §5.3.3. The network shall stop timer T304 (if running) for this user.

If other called users have responded to the SETUP message with a SETUP ACKNOWLEDGE, CALL PROCEEDING or ALERTING message, and still have the opportunity to accept the call by sending a CONNECT message, the network shall retain the cause in the DISCONNECT message. The network shall continue to process the incoming call for the remaining responding users, (T310 or T301, if running, shall continue to run).

If either:

- a) no other users have responded to the incoming call; or
- b) all users that have responded to the incoming call have been cleared or are in the process of being cleared:

the network shall stop timer T310 or T301 (if running) and shall clear the call to the calling user. If an ALERTING message has been received, the cause sent to the calling user shall be a cause received from the called user, giving preference to (in order of priority): #21 "call rejected"; or any other cause sent by a called user. If only SETUP ACKNOWLEDGE, CALL PROCEEDING messages have been received, the cause sent to the calling user shall be a cause received from the called user, giving preference to (in order of priority): #17 "user busy"; #21 "call rejected"; any other appropriate cause sent by a called user.

5.2.5.4 Call failure

If the network does not receive any response to the retransmitted SETUP message prior to the expiration of timer T303, then the network shall initiate clearing procedures towards the calling user with cause #18 "no user responding".

- i) If the SETUP message was delivered by a broadcast data link, the network shall enter the Call Abort state.
- ii) If the SETUP message was delivered on a point-to-point data link, the network shall also initiate clearing procedures towards the called user in accordance with §5.3.4, using cause #102 "recovery on timer expiry".

If the network receives a user's first response to SETUP message when in the Call Abort state but before timer T312 has expired, the network shall initiate clearing to the called user as described in §5.3.2 (b), except that the cause #102 "recovery on timer expiry" shall be sent.

If the network receives a message that is a user's first response to an incoming call after timer T312 has expired, the network will interpret this message as a message received with an invalid call reference value, as described in §5.8.3.2.

If the network has received a CALL PROCEEDING message, but does not receive an ALERTING, CONNECT, or DISCONNECT message prior to the expiration of timer T310, then the network shall: initiate clearing procedures towards the calling user with cause #18 "no user responding"; and initiate clearing procedures towards the called user.

- i) If the SETUP message was delivered by a broadcast data link, the called user shall be cleared in accordance with §5.3.2 e), except that cause #102 "recovery on timer expiry" shall be sent.
- ii) If the SETUP message was delivered on a point-to-point data link, the called user shall be cleared in accordance with §5.3.4, using cause #102 "recovery on timer expiry".

If the network has received an ALERTING message, but does not receive a CONNECT or DISCONNECT MESSAGE prior of the expiry of timer T301 (or a corresponding internal alerting supervision timing function), then the network shall: initiate clearing procedures towards the calling user with cause #19 "user alerting, no answer"; and initiate clearing procedures towards the called user.

- i) If the SETUP message was delivered by a broadcast data link, the called user shall be cleared in accordance with §5.3.2 (e), except that cause #102 "recovery on timer expiry" shall be sent.
- ii) If the SETUP message was delivered on a point-to-point data link, the called user shall be cleared in accordance with §5.3.4, using cause #102 "recovery on timer expiry".

5.2.6 Notification of interworking at the terminating interface

During call establishment the call may enter an ISDN environment, e.g. because of interworking with another network, with a non-ISDN user, or with non-ISDN equipment within the calling or called user's premises. When this occurs, the point at which the call enters an ISDN environment shall cause a Progress indicator information element to be included in the SETUP message to be sent to the called user:

- a) #1 "call is not end-to-end ISDN; further call progress information may be available in-band";

NOTE: On receipt of progress indicator #1, the called user shall connect to the B-channel in accordance with the procedures of §5.2.8.

- b) #3 "origination address is non-ISDN".

In addition, the user shall notify the calling party if the call has left the ISDN environment within the called user's premises, or upon the availability of in-band information/patterns. When such situations occur a progress indication shall be sent by the user to the network either:

- a) in an appropriate call control message when a state change is required (SETUP ACKNOWLEDGE, CALL PROCEEDING, ALERTING or CONNECT); or,
- b) in the PROGRESS message when no state change is appropriate.

One of the following progress description values shall be included in the Progress indicator information element in the message sent to the network (for further information, see Annex I):

- a) #1 "call is not end-to-end ISDN; further call progress information may be available in-band".
- b) #2 "destination address is non-ISDN".
- c) #4 "call has returned to the ISDN".

If the Progress indicator information element is included in a call control message, the procedures as described in the rest of §5.2 apply. If the Progress indicator information element is included in the PROGRESS message, no state change will occur but any supervisory timers shall be stopped.

ETSI Requirement: If the Progress indicator information element is included in the PROGRESS message, ETSI ISDNs will stop any supervisory timer except network timers T304 and T312.

5.2.7 Call accept

A user indicates acceptance of an incoming call by sending a CONNECT message to the network. Upon sending the CONNECT message the user shall start timer T313 (the value of timer T313 is specified in §9.2). If an ALERTING message had previously been sent to the network, the CONNECT message may contain only the call reference.

If a call can be accepted using the B-channel indicated in the SETUP message, and no user alerting is required, a CONNECT message may be sent without a previous ALERTING message.

NOTE: Further study is required on the need for means to avoid service degradation (e.g. speech clipping) on connections involving an NT2.

5.2.8 Active indication

On receipt of the first CONNECT message, the network shall: stop (if running) timers T301, T303, T304 and T310; complete the circuit switched path to the selected B-channel; send a CONNECT ACKNOWLEDGE message to the user which first accepted the call; initiate procedures to send a CONNECT message towards the calling user; and enter the Active state.

The CONNECT ACKNOWLEDGE message indicates completion of the circuit switched connection. There is no guarantee of an end-to-end connection until CONNECT message is received at the calling user. Upon receipt of the CONNECT ACKNOWLEDGE message the user shall: stop timer T313 and enter the Active state.

When timer T313 expires prior to the receipt of a CONNECT ACKNOWLEDGE message, the user shall initiate clearing in accordance with §5.3.3.

A user which has received the SETUP message via the broadcast data link, and has been awarded the call, shall connect to the B-channel only after it has received the CONNECT ACKNOWLEDGE message. Only the user that is awarded the call will receive the CONNECT ACKNOWLEDGE message.

A user which has received the SETUP message via a point-to-point data link may connect to the B-channel as soon as channel selection has been completed.

5.2.9 Non-selected user clearing

In addition to sending the CONNECT ACKNOWLEDGE message to the user selected for the call, the network shall send RELEASE messages (as described in §5.3.2 b)) to all other users at the interface that have sent SETUP ACKNOWLEDGE, CALL PROCEEDING, ALERTING or CONNECT message in response to SETUP message. These RELEASE messages are used to notify the users that the call is no longer offered to them. The procedures described in §5.3.4 are then followed. Any user which having previously sent a CONNECT message and started timer T313, and which subsequently receives a RELEASE message, shall stop timer T313 and follow the procedures of §5.3.4.

5.3 Call clearing

5.3.1 Terminology

The following terms are used in this ETS in the description of clearing procedures:

- A channel is "connected" when the channel is part of a circuit switched ISDN connection established according to this ETS.
- A channel is "disconnected" when the channel is no longer part of a circuit switched ISDN connection, but is not yet available for use in a new connection.
- A channel is "released" when the channel is not part of a circuit switched ISDN connection and is available for use in a new connection. Similarly, a call reference that is "released" is available for reuse.

5.3.2 Exception conditions

Under normal conditions, call clearing is usually initiated when the user or the network sends a DISCONNECT message and follows the procedures defined in §§5.3.3 and 5.3.4 respectively. The only exceptions to the above rule are as follows:

- a) In response to a SETUP message, the user or network can reject a call (e.g. because of the unavailability of a suitable B-channel) by: responding with a RELEASE COMPLETE message provided no other response has previously been send (e.g. the SETUP ACKNOWLEDGE message in the case of overlap sending); releasing the call reference; and enter the Null state.

- b) In the case of a multipoint terminal configuration, non-selected user call clearing will be initiated with RELEASE message(s) from the network (see §5.2.9). The RELEASE message shall contain cause #26 "non-selected user clearing".
- c) Clearing of temporary signalling connections will be initiated by a sending a RELEASE message as described in §§5.3.3 and 5.3.4.
- d) Unsuccessful termination of the B-channel selection procedure (see §§5.2.3.1 and 5.1.2) by the side offering the call is accomplished by sending a RELEASE message as described in §§5.3.3 and 5.3.4. The RELEASE message shall contain cause #6 "channel unacceptable".
- e)
 - [1] In the case of a SETUP message sent via the broadcast data link, if a network disconnect indication is received during call establishment, and prior to the expiry of timer T312, timer T303 is stopped (if running) and the network enters the Call Abort state. Any user which has responded, or subsequently responds before timer T312 expires, will be cleared by a RELEASE message (with the cause code(s) contained in the network disconnect indication) and the procedures of §5.3.4 are then followed for that user. Upon expiry of timer T312, the network shall treat any subsequent responses according to the procedures defined in §5.8.3.2. The network shall enter the Null state upon completion of clearing procedures for all responding users.
 - [2] In the case of a SETUP message sent via the broadcast data link, if a network disconnect indication is received during call establishment after expiry of timer T312, any user which has responded shall be cleared by a RELEASE message (with the cause code(s) contained in the network disconnect indication) and the procedures of §5.3.4 are then followed for that user. The network enters the Null state upon completion of clearing procedures for all responding users.

NOTE: A separate state machine exists for each responding user.

- f) When timer T318 expires, the user initiates internal call clearing by sending a RELEASE message with cause #102 "recovery on timer expiry"; starting timer T308; and continuing as described in §5.3.3.

5.3.3 Clearing initiated by the user

Apart from the exceptions identified in §§5.3.2 and 5.8, the user shall initiate clearing by: sending a DISCONNECT message; starting timer T305 (the value of timer T305 is specified in §9.2); disconnecting the B-channel; and entering the Disconnect Request state.

NOTE: When a user initiates call clearing by sending a RELEASE message, the procedures described in §5.3.4 are then followed.

The network shall enter the Disconnect Request state upon receipt of a DISCONNECT message. This message then prompts the network to disconnect the B-channel, and to initiate procedures for clearing the network connection to the remote user. Once the B-channel used for the call has been disconnected, the network shall: send a RELEASE message to the user; start timer T308 (the value of timer T308 is specified in §9.1); and enter the Release Request state.

NOTE: The RELEASE message has only local significance and does not imply an acknowledgement of clearing from the remote user.

On receipt of the RELEASE message the user shall: cancel timer T305; release the B-channel; send a RELEASE COMPLETE message; release the call reference; and return to the Null state. Following the receipt of a RELEASE COMPLETE message from the user, the network shall: stop timer T308; release both the B-channel and the call reference; and return to the Null state.

If timer T305 expires, the user shall: send a RELEASE message to the network with the cause number originally contained in the DISCONNECT message; start timer T308 and enter the Release Request state.

In addition, the user may indicate a second cause information element with cause #102 "recovery on timer expiry".

If timer T308 expires for the first time, the network shall: retransmit the RELEASE message and timer T308 shall be restarted. In addition, the network may indicate a second Cause information element with cause #102 "recovery on timer expiry". If no RELEASE COMPLETE message is received from the user before timer T308 expires a second time, the network shall: place the B-channel in a maintenance condition; release the call reference; and return to the Null state.

NOTE 1: The restart procedures contained in §5.5 may be used on B-channels in the maintenance condition.

NOTE 2: Other actions which could be taken by the network upon receipt of a DISCONNECT message are for further study.

ETSI Requirement: The actions to be taken with regard to the maintenance condition are network dependent.

5.3.4 Clearing initiated by the network

Apart from the exception conditions identified in §§5.3.2 and 5.8, the network shall initiate clearing by: sending a DISCONNECT message; and entering the Disconnect Indication state. The DISCONNECT message is a local invitation to clear and does not imply that the B-channel has been disconnected at the user-network interface.

NOTE: When the network initiates clearing by sending a RELEASE message, the procedures described in §5.3.3 are followed.

5.3.4.1 Clearing when tones/announcements provided

When in-band tones/announcements are provided (see §5.4), the DISCONNECT message contains progress indicator #8 "in-band information or appropriate pattern now available". The network shall: start timer T306; and enter the Disconnect Indication state.

On receipt of the DISCONNECT message with progress indicator #8, the user may: connect (if not already connected) to the B-channel to receive the in-band tone/announcement; and enter the Disconnect Indication state. Alternatively, to continue clearing without connecting to the in-band tone/announcement, the user shall: disconnect the B-channel; and send a RELEASE message; start timer T308; and enter the Release Request state.

If the user connects to the provided in-band tone/announcement, the user may subsequently continue clearing (before the receipt of a RELEASE message from the network) by: disconnecting from the B-channel; sending a RELEASE message; starting timer T308; and entering the Release Request state.

On receipt of the RELEASE message, the network shall: stop timer T306; disconnect and release the B-channel; send a RELEASE COMPLETE message; release the call reference; and return to the Null state.

If timer T306 expires, the network shall continue clearing by: disconnecting the B-channel; sending a RELEASE message with the cause number originally contained in the DISCONNECT message; starting timer T308; and entering the Release Request state.

In addition to the original clearing cause, the RELEASE message may contain a second Cause information element with cause #102 "recovery on timer expiry"; this cause may optionally contain a diagnostic field identifying the timer that expired.

On receipt of the RELEASE message, the user shall act according to §5.3.3.

5.3.4.2 Clearing when tones/announcements not provided

When in-band tones/announcements are not provided, the DISCONNECT message does not contain progress indicator #8 "in-band information or appropriate pattern now available". The network shall initiate clearing by: sending the DISCONNECT message; starting timer T305; disconnecting the B-channel; and entering the Disconnect Indication state.

On the receipt of the DISCONNECT message without progress indicator #8, the user shall: disconnect the B-channel; send a RELEASE message; start timer T308; and enter the Release Request state.

On receipt of the RELEASE message, the network shall: stop timer T305; release the B-channel; send a RELEASE COMPLETE message; release the call reference; and return to the Null state.

If timer T305 expires, the network shall: send a RELEASE message to the user with the cause number originally contained in the DISCONNECT message; start timer T308; and enter the Release Request state. In addition to the original clearing cause, the RELEASE message may contain a second cause information element with cause #102 "recovery on timer expiry".

5.3.4.3 Completion of clearing

Following the receipt of a RELEASE COMPLETE message from the network, the user shall: stop timer T308; release both the B-channel and the call reference; and return to the Null state.

If a RELEASE COMPLETE message is not received by the user before the first expiry of timer T308, the RELEASE message shall be retransmitted and timer T308 shall be restarted. If no RELEASE COMPLETE message is received from the network before timer T308 expires a second time, the user may: place the B-channel in a maintenance condition; shall release the call reference; and return to the Null state.

NOTE: The restart procedures contained in §5.5 may be used on B-channels in the maintenance condition.

ETSI requirement: The option of placing the B-channel in the maintenance condition is not applicable in the case of point-to-multipoint configurations.

5.3.5 Clear collision

Clear collision occurs when both the user and the network simultaneously transfer DISCONNECT messages specifying the same call reference value. When the network receives a DISCONNECT message whilst in the Disconnect Indication state, the network shall: stop timer T305 or T306 (whichever is running); disconnect the B-channel (if not disconnected); send a RELEASE message; start timer T308; and enter the Release Request state. Similarly, when the user receives a DISCONNECT message whilst in the Disconnect Request state, the user shall: stop timer T305; send a RELEASE message; start timer T308; and enter the Release Request state.

Clear collision can also occur when both sides simultaneously transfer RELEASE messages related to the same call reference value. The entity receiving such a RELEASE message whilst within the Release Request state shall: stop timer T308; release the call reference and B-channel; and enter, if appropriate, the Null state (without sending or receiving a RELEASE COMPLETE message).

5.4 In-band tones and announcements

When in-band tones/announcements not associated with a call state change are to be provided by the network before reaching the Active state, a PROGRESS message is returned simultaneously with the application of the in-band tone/ announcement. The PROGRESS message contains the progress indicator #8 "in-band information or appropriate pattern is now available".

When tones/announcements have to be provided together with a call state change, then the appropriate message (e.g. for ALERTING, DISCONNECT, etc. -- see appropriate section) with progress indicator #8 "in-band information or appropriate pattern is now available" is sent simultaneously with the application of the in-band tone/announcement.

NOTE 1: When the network provides CCITT-standardized telecommunication services, the service requirement for provision of in-band tones/announcements is as indicated in the CCITT I.200 series of Recommendations.

NOTE 2: When the PROGRESS message is used, the user may initiate call clearing as a result of the applied in-band tone/announcement, according to the procedures specified in §5.3.3.

NOTE 3: The protocol currently described in §5.4 applies at the calling user-network interface. The protocol to be applied at the inter-network interface and at the called user-network interface requires further study.

5.5 Restart procedure

The restart procedure is used to return channels and interfaces to an idle condition. The procedure is usually invoked when the other side of the interface does not respond to other call control messages or a failure has occurred (e.g. following a data link failure, when a backup D-channel can be used; or following the expiry of timer T308 due to the absence of response to a clearing message). It may also be initiated as a result of local failure, maintenance action or mis-operation.

NOTE: Layer 3 procedures and resources associated with those data links with SAPI= "0000 000" should be initialized by the restart procedures.

When:

- a) both the user and the network are aware of the configuration of the interface; and,
- b) the interface is a basic access (CCITT Recommendation I.430) where a point-to-point configuration exists; or,
- c) the interface is a primary rate access (CCITT Recommendation I.431);

then the user and the network shall implement the procedures of §5.5. In all other cases, the procedures of §5.5 are optional.

5.5.1 Sending RESTART

A RESTART message is sent by the network or user in order to return channels or interfaces to the Null state. The Channel identification information element must be present in the RESTART message when a specified channel, or interface other than the one containing the D-channel, is to be returned to the idle condition. Absence of the Channel identification information element indicates that the interface containing the D-channel is to be restarted.

Upon transmitting the RESTART message the sender enters the Restart Request state REST 1, starts timer T316, and waits for a RESTART ACKNOWLEDGE message. Also, no further RESTART messages shall be sent until a RESTART ACKNOWLEDGE message is received or timer T316 expires. Receipt of a RESTART ACKNOWLEDGE message stops timer T316, frees the channels and call reference values for reuse, and enters the Null state.

If a RESTART ACKNOWLEDGE message is not received prior to expiry of timer T316 one or more subsequent RESTART messages may be sent until a RESTART ACKNOWLEDGE message is returned. Meanwhile, no calls shall be placed or accepted over the channel or interface by the originator of the RESTART message. A network shall limit the number of consecutive unsuccessful restart attempts to a default limit of two. When this limit is reached, the network shall make no further restart attempts. An indication will be provided to the appropriate maintenance entity. The channel or interface is considered to be in an out-of-service condition until maintenance action has been taken.

ETSI requirement: If a RESTART ACKNOWLEDGE message is received indicating only a subset of the specified channels, an indication shall be given to the maintenance entity to determine what actions shall be taken on the channel(s) which have not been returned to the idle condition.

The RESTART and RESTART ACKNOWLEDGE message shall contain the global call reference value (all zero) to which the Restart Request state is associated. These messages are transferred via the appropriate point-to-point data link in the multiple frame mode using the DL-DATA-REQUEST primitive.

5.5.2 Receipt of RESTART

Upon receiving a RESTART message the recipient shall enter the Restart state associated to the global call reference and start timer T317; it shall then initiate the appropriate internal actions to return the specified channels to the idle condition and call references to the Null state. Upon completion of internal clearing, timer T317 shall be stopped and a RESTART ACKNOWLEDGE message transmitted to the originator, and the Null state entered.

ETSI requirement: If only a subset of the specified channels have been returned to the idle condition when timer T317 expires, a RESTART ACKNOWLEDGE message should be transmitted to the originator, containing a Channel identification information element indicating the channel(s) that have been returned to the idle condition.

If timer T317 expires prior to completion of internal clearing an indication shall be sent to the maintenance entity (i.e. a primitive should be transmitted to the system management entity).

NOTE 1: Even if all call references are in the Null state, and all channels are in the idle condition, the receiving entity shall transmit a RESTART ACKNOWLEDGE message to the originator upon receiving a RESTART message.

NOTE 2: If the RESTART message is sent by a user, the network The receiving entity shall return to the Null state only those ETS 300 102-1 calls which are:

- a) associated with the data link connection endpoint identifier (DLCI; see ETS 300 125); and,
- b) which correspond to the specified channel(s) or interface.

The following entities shall be released:

- a) B-channels established by Q.931 messages including channels used for packet access (case B) (consequently all virtual calls carried in the released channel(s) will be handled as described in §6.4.1);
- b) User signalling bearer service connections.

The following entities shall not be released:

- a) Semi-permanent connections that are established by man-machine commands;
- b) Entities associated with any other DLCI.

If semi-permanent connections established by man-machine commands are implicitly specified (by specifying "single interface" or "all interfaces"), no action shall be taken on those channels but a RESTART ACKNOWLEDGE message shall be returned containing the appropriate indications (i.e. "single interface" or "all interfaces").

If semi-permanent connections established by man-machine commands are explicitly specified (by including a Channel identification information element in the RESTART message), no action shall be taken on those channels and a STATUS message shall be returned with cause #82 "identified channel does not exist" optionally indicating in the diagnostic field the channel(s) that could not be handled.

5.6 Call rearrangements

The elements of procedure in this section provide for physical layer and/or data link layer rearrangements after a call has entered the Active state as defined in §2.2.1.5. The procedure is restricted to use on the same interface structure, and resumption on the same B-Channel.

ETSI requirement: The use of the call rearrangement procedure is restricted to basic access, i.e. it will not be available for primary rate access. For call rearrangements controlled by an NT2, see §5.6.7.

The activation of this procedure at a user-network interface may correspond to a number of possible events such as the following:

- a) physical disconnection of user equipment and reconnection;
- b) physical replacement of one user equipment by another;
- c) the human user moves from one equipment to another;
- d) suspension of call and its subsequent reactivation at the same user equipment.

These procedures have only local significance; i.e. the invocation of call rearrangement affects only states at the originating end, and it does not affect any terminating states.

The procedures in this section are described in terms of functional messages and information elements.

If the procedures for call suspension in this section are not followed prior to the physical disconnection of the terminal from the interface, then the integrity of the call cannot be guaranteed by the network.

5.6.1 Call suspension

The procedure is initiated by the user, who shall: send a SUSPEND message containing the current call reference; start timer T319; and enter the Suspend Request state. The user may optionally include in this message a bit sequence (e.g. IA5 characters) to be known by the application or human user, and by the network, as the call identity for subsequent reconnection. Where no call identity information is included by the user, (e.g. the Call identity information element is absent or empty) the network shall store this fact so that resumption is possible only by a procedure conveying no call identity information.

NOTE: If the Call identity information element is present with a null length, the message shall be handled as if it was absent.

The default maximum length of the call identity value within the Call identity information element is eight octets. If the network receives a call identity value longer than the maximum length supported, the network shall truncate the call identity value to the maximum length; take the action specified in §5.8.7.2; and continue processing.

ETSI requirement: Some networks may only support a maximum length of the call identity value of two octets.

5.6.2 Call suspended

Following the receipt of a SUSPEND message the network enters the Suspend Request state. After a positive validation that the received call identity is not currently in use the network shall: send a SUSPEND ACKNOWLEDGE message; and start timer T307. (The value of T307 is specified in §9.1).

At this time the network shall consider the call reference to be released and enter the Null state for that call reference. The call identity associated with the suspended call has to be stored by the network and cannot be accepted for another suspension until it is released.

The B-channel involved in the connection will be reserved by the network until reconnection of the call (or until a clearing cause occurs; e.g. expiry of timer T307). A NOTIFY message with notification indicator #0 "user suspended" is sent to the other user.

ETSI requirement: Some networks may only support a maximum length of the call identity value of two octets.

When the user receives the SUSPEND ACKNOWLEDGE message, the user shall: stop timer T319; release the B-channel and call reference; and enter the Null state.

Following the receipt of the SUSPEND ACKNOWLEDGE message, the user may disconnect the underlying data link connection. In any case, if the user physically disconnects from the interface without having disconnected the data link connection, standard data link layer procedures are started by the network side of the data link layer supervision, resulting in the release of the data link layer connection.

5.6.3 Call suspend error

ETSI requirement: If the network does not support the call rearrangement procedures, it shall reject a SUSPEND message according to the error handling procedures of §5.8.4. If the network supports the call rearrangement procedures on a subscription basis, but the user does not subscribe to the service, the network shall reject a SUSPEND message by sending a SUSPEND REJECT message with cause #50 "requested facility not subscribed"; the Cause information element shall not contain a diagnostic field under these circumstances.

On receipt of a SUSPEND message, the network will respond by sending a SUSPEND REJECT message with cause #84 "call identity in use" if the information contained in the SUSPEND message is not sufficient to avoid ambiguities on subsequent call re-establishment. This will apply, in particular, when at a given user-network interface, a SUSPEND message is received with a call identity sequence already in use, or when the SUSPEND message does not contain any call identity sequence and the null-value call identity is already allocated for that interface. On receipt of the SUSPEND REJECT message the user shall: stop timer T319; and return to the Active state. If timer T319 expires, the user shall: notify the user application; and return to the Active state.

In these cases the state of the call is not altered within the network (i.e. it remains in the Active state).

5.6.4 Call re-establishment

At the connection end where suspension was initiated, the user may request re-establishment of a call after physical reconnection of a terminal by sending a RESUME message containing the call identity exactly as that used at the time of call suspension; starting timer T318; and entering the Resume Request state. If the SUSPEND message did not include a call identity information element, then the corresponding RESUME message shall also not include a Call identity information element. The call reference included in the RESUME message is chosen by the user according to the normal allocation of outgoing call reference (see §4.3).

On receipt of a RESUME message, the network enters the Resume Request state. After a positive validation of the call identity that relates to the suspended call, the network shall: send a RESUME ACKNOWLEDGE message to the user; release the call identity; stop timer T307 and enter the Active state. The RESUME ACKNOWLEDGE message shall specify the B-channel reserved to the call by the network by means of the Channel identification information element, coded "B-channel is indicated, no alternative is acceptable".

The network shall also send a NOTIFY message with the notification indicator #1 "user resumed" to the other user.

ETSI requirement: Some networks may not support the use of the NOTIFY message.

No memory of the previously received call identity sequence is kept by the network after sending the RESUME ACKNOWLEDGE message. This call identity is now available for another suspension.

On receipt of the RESUME ACKNOWLEDGE message, the user shall: stop timer T318 and enter the Active state.

ETSI Requirement: No compatibility checking is performed during the call re-establishment phase.

5.6.5 Call resume errors

If the network does not support the call rearrangement procedures, it may reject a RESUME message according to the error handling procedures of §5.8.3.2 a). For this purpose, the RESUME message would be deemed to be an unrecognized message.

If a received RESUME message cannot be actioned by the network (e.g. as a result of an unknown call identity), a RESUME REJECT message shall be returned to the requesting user indicating one of the following causes:

- a) #83 "a suspended call exists, but this call identity does not";
- b) #85 "no call suspended"; or,
- c) #86 "call having the requested call identity has been cleared".

The call identity remains unknown. The call reference contained in the RESUME message is released by both the user and network side. Upon receipt of the RESUME REJECT message the user shall: stop timer T318; and enter the Null state.

If timer T307 expires the network shall initiate clearing of the network connection with cause #102 "recovery on timer expiry"; discard the call identity; and release the reserved B-channel.

On release, the call identity can then be used for subsequent call suspension. If before the expiry of timer T307 the call is cleared by the remote user, the B-channel reservation is released but the call identity may be preserved by some networks along with a clearing cause (e.g. cause #16 "normal clearing").

If timer T318 expires, the user shall initiate internal call clearing with cause #102 "recovery on timer expiry", in accordance with §5.3.2 (f).

5.6.6 Double suspension

Simultaneous suspension of the call at both ends is possible. The procedures do not prevent this from occurring. If double suspensions are not desired the user must protect against this by other means; e.g. higher layer negotiation protocols.

5.6.7 Call re-arrangement notification controlled by an NT2

When the call rearrangement is controlled by the NT2, the procedures shall be applied by the NT2 at reference point S. The NT2 shall inform the remote user by sending a NOTIFY message described in §§5.6.2 and 5.6.4 across reference point T.

5.7 Call collisions

Call collisions as such cannot occur at the network. Any simultaneous incoming or outgoing calls are dealt with separately and assigned different call references.

Channel selection conflicts may occur if an incoming call and outgoing call select the same channel. This is resolved by the network through channel selection mechanisms described in §§5.1.2 and 5.2.3.

In the case of such conflicts, the network shall give priority to the incoming call over the call request received from the user. It shall clear the outgoing call whenever the B-channel can not be allocated by the network or accepted by the user originating the call.

NOTE: Some terminal adaptors supporting existing non-voice terminals (e.g. X.21) may need to resolve double channel selection by clearing the incoming call and reattempting the outgoing call setup in order to satisfy the requirements of the interface at reference point R.

5.8 Handling of error conditions

All procedures transferring signalling information by using the protocol discriminator of Q.931 (I.451) user-network call control messages are applicable only to those messages which pass the checks described in §§5.8.1 through 5.8.7.

Detailed error handling procedures are implementation dependent and may vary from network to network. However, capabilities facilitating the orderly treatment of error conditions are provided for in this section and shall be provided in each implementation.

§§5.8.1 through 5.8.7 are listed in order of precedence.

5.8.1 Protocol discrimination error

When a message is received with a protocol discriminator coded other than "Q.931(I.451) user-network call control message", that message shall be ignored. "Ignore" means to do nothing, as if the message had never been received.

5.8.2 Message too short

When a message is received that is too short to contain a complete message type information element, that message shall be ignored.

5.8.3 Call reference error

5.8.3.1 Invalid call reference format

If the Call reference information element octet 1, bits 5 through 8 do not equal 0000, then the message shall be ignored.

If the Call reference information element octet 1, bits 1 through 4 indicate a length greater than the maximum length supported by the receiving equipment (see §4.3), then the message shall be ignored.

ETSI requirement: When a message associated with the basic call is received specifying the dummy call reference, this message shall be ignored.

5.8.3.2 Call reference procedural errors

a) Whenever any message except SETUP, RELEASE, RELEASE COMPLETE, STATUS or (for networks supporting the call rearrangement procedures of §5.6) RESUME is received specifying a call reference which is not recognized as relating to an active call or to a call in progress, clearing is initiated by sending a RELEASE message with cause #81 "invalid call reference value" and following the procedures in §5.3, specifying the call reference in the received message.

Alternatively, the receiving entity may send a RELEASE COMPLETE message with cause #81 "invalid call reference value" and remain in the Null state.

b) When a RELEASE message is received that specified a call reference which is not recognized as relating to an active call or to a call in progress, a RELEASE COMPLETE message with cause #81 "invalid call reference value" is returned specifying the call reference in the received message.

c) When a RELEASE COMPLETE message is received specifying a call reference which is not recognized as relating to an active call or to a call in progress, no action should be taken

- d) When a SETUP or RESUME message is received specifying a call reference which is not recognized as relating to an active call or to a call in progress, and with a call reference flag incorrectly set to "1", this message shall be ignored.
- e) When a SETUP message is received specifying a call reference which is recognized as relating to an active call or to a call in progress, this SETUP message shall be ignored.
- f) When any message except RESTART, RESTART ACKNOWLEDGE or STATUS is received using the global call reference, no action should be taken on this message and a STATUS message using the global call reference with a call state indicating the current state associated with the global call reference and cause #81 "invalid call reference" shall be returned.
- g) When a STATUS message is received specifying a call reference which is not recognized as relating to an active call or to a call in progress, the procedures of §5.8.11 shall apply.

5.8.4 Message type or message sequence errors

Whenever an unexpected message, except RELEASE or RELEASE COMPLETE, or unrecognized message is received in any state other than the Null state, a STATUS message shall be returned with cause #98 "message not compatible with call state or message type non-existent or not implemented" and, optionally, the corresponding diagnostic. If a network or user can distinguish between un-implemented (or non-existent) message types and implemented message types which are incompatible with the call state, then a STATUS message may be sent with one of the following causes:

- a) cause #97 "message type non-existent or not implemented"; or,
- b) cause #101 "message not compatible with call state".

Alternatively, a STATUS ENQUIRY message may be sent requesting the call state of the entity (see §5.8.10). No change in state shall be made in either case at this time.

However, two exceptions to this procedure exist. The first exception is when the network or the user receives an unexpected RELEASE message (e.g. if the DISCONNECT message was corrupted by undetected transmission errors). In this case no STATUS or STATUS ENQUIRY message is sent. Whenever the network receives an unexpected RELEASE message, the network shall: disconnect and release the B-channel; clear the network connection and the call to the remote user with the cause in the RELEASE message sent by the user or, if not included, cause #31 "normal, unspecified"; return a RELEASE COMPLETE message to the user; release the call reference; stop all timers and enter the Null state. Whenever the user receives an unexpected RELEASE message, the user shall: disconnect and release the B-channel; return a RELEASE COMPLETE message to the network; release the call reference; stop all timers and return to the Null state.

The second exception is when the network or the user receives an unexpected RELEASE COMPLETE message. Whenever the network receives an unexpected RELEASE COMPLETE message, the network shall: disconnect and release the B-channel; clear the network connection and the call to the remote user with the cause indicated by the user or, if not included, cause #111 "protocol error, unspecified"; release the call reference; stop all timers and enter the Null state. Whenever the user receives an unexpected RELEASE COMPLETE message, the user shall: disconnect and release the B-channel; release the call reference; stop all timers and enter the Null state.

5.8.5 General information element errors

The general information element error procedures may also apply to information elements in codesets other than 0. In that case, the diagnostics in the cause information element may indicate information elements other than those in codeset 0 by applying the locking or non-locking shift procedures as described in §4.5.

ETSI Requirement: The use of the locking or non-locking shift procedures in the diagnostic field of the cause information element only applies to the interpretation of the information element identifiers of the information elements in codesets other than 0 without any impact on the interpretation of the information element itself.

5.8.5.1 Information element out of sequence

A variable Length information element which has a code value lower than the code value of the variable length information element preceding it shall be considered as an out of sequence information element.

If the network or user receives a message containing an out of sequence information element, it may ignore this information element and continue to process the message. If this information is mandatory, and the network or the user chooses to ignore this out of sequence information elements, then the error handling procedure for missing mandatory information elements as described in §5.8.6.1 shall be followed. If the ignored information element is non-mandatory, the receiver continues to process the message.

NOTE: Some implementations may choose to process all the information elements received in a message regardless of the order in which they are placed.

5.8.5.2 Duplicated information elements

If an information element is repeated in a message in which repetition of the Information element is not permitted, only the contents of information element appearing first shall be handled and all subsequent repetitions of the information element shall be ignored. When repetition of the information elements is permitted, only the contents of permitted information elements shall be handled. If the limit on repetition of information elements is exceeded, the contents of information elements appearing first up to the limit of repetitions shall be handled and all subsequent repetitions of the information element shall be ignored.

5.8.6 Mandatory information element errors

5.8.6.1 Mandatory information element missing

When a message other than SETUP, DISCONNECT, RELEASE or RELEASE COMPLETE is received which has one or more mandatory information elements missing, no action should be taken on the message and no state change should occur. A STATUS message is then returned with cause #96 "mandatory information element is missing".

When a SETUP or RELEASE message is received which has one or more mandatory information elements missing, a RELEASE COMPLETE message with cause #96 "mandatory information element is missing" shall be returned.

When a DISCONNECT message is received with the cause information element missing, the actions taken shall be the same as if a DISCONNECT message with cause #31 "normal, unspecified" was received (see §5.3), with the exception that the RELEASE message sent on the local interface contains cause #96 "mandatory information element is missing".

When a RELEASE COMPLETE message is received with a cause information element missing, it will be assumed that a RELEASE COMPLETE message was received with cause #31 "normal, unspecified".

5.8.6.2 Mandatory information element content error

When a message other than SETUP, DISCONNECT, RELEASE or RELEASE COMPLETE is received which has one or more mandatory information elements with invalid content, no action should be taken on the message and no state change should occur. A STATUS message is then returned with cause #100 "invalid information element contents".

When a SETUP or RELEASE message is received which has one or more mandatory information elements with invalid content, a RELEASE COMPLETE message with cause #100 "invalid information element contents shall be returned.

When a DISCONNECT message is received with invalid content of the cause information element, the actions taken shall be the same as if a DISCONNECT message with cause #31 "normal unspecified" was received (see §5.3), with the exception that the RELEASE message sent on the local interface contains cause #100 "invalid information element contents".

When a RELEASE COMPLETE message is received with invalid content of the cause information element, it will be assumed that a RELEASE COMPLETE message was received with cause #31 "normal, unspecified".

Information elements with a length exceeding the maximum length (given in §3) will be treated as information element with content error.

5.8.7 Non-mandatory information element errors

The following sections identify actions on information elements not recognized as mandatory.

5.8.7.1 Unrecognized information element

When a message is received which has one or more unrecognized information elements, the receiving entity shall check whether any are encoded to indicate "comprehension required" (refer to table 4.3 for information element identifiers reserved with this meaning). If any unrecognized information element is encoded to indicate "comprehension required", then the procedures in §5.8.6.1 are followed; i.e. as if a "missing mandatory information element" error condition had occurred. If all unrecognized information elements are not encoded to indicate "comprehension required", then the receiving entity shall proceed as follows:

Action shall be taken on the message and those information elements which are recognized and have valid content. When the received message is other than DISCONNECT, RELEASE or RELEASE COMPLETE, a STATUS message may be returned containing one cause information element. The STATUS message indicates the call state in which the receiver detected the error. The Cause information element shall contain cause #99 "information element non-existent or not implemented", and the diagnostic field, if present, shall contain the information element identifier for each information element which was unrecognized.

Subsequent actions are determined by the sender of the unrecognized information elements. If a clearing message contains one or more unrecognized information elements, the error is reported to the local user in the following manner:

- a) When a DISCONNECT message is received which has one or more unrecognized information elements, a RELEASE message with cause #99, "information element non-existent or not implemented", shall be returned. The Cause information element diagnostic field, if present, shall contain the information element identifier for each information element which was unrecognized.
- b) When a RELEASE message is received which has one or more unrecognized information elements, a RELEASE COMPLETE message with cause #99 "information element non-existent or not implemented", shall be returned. The Cause information element diagnostic field, if present, shall contain the information element identifier for each information element which was unrecognized.
- c) When a RELEASE COMPLETE message is received which has one or more unrecognized information elements, no action shall be taken on the unrecognized information.

NOTE: The diagnostic(s) of cause #99 facilitates the decision in selecting an appropriate recovery procedure at the reception of a STATUS message. Therefore, it is recommended to provide cause #99 with diagnostic(s) if a layer 3 entity expects the peer entity to take an appropriate action at the receipt of a STATUS message, although inclusion of diagnostic(s) is optional.

5.8.7.2 Non-mandatory information element content error

When a message is received which has one or more non-mandatory information elements with invalid content, action shall be taken on the message and those information elements which are recognized and have valid content. A STATUS message may be returned containing one Cause information element. The STATUS message indicates the call state in which the receiver detected the error. The Cause information element shall contain cause #100 "invalid information element contents", and the diagnostic field, if present, shall contain the information element identifier for each information element which has invalid contents,

Information elements with a length exceeding the maximum length (given in §3) will be treated as an information element with content error. But for access information elements (See Annex G; e.g. User-user information element, Called party sub-address information element), cause #43 "access information discarded" is used instead of cause #100 "invalid information element contents" in the STATUS message. However, in some networks, access information elements may be truncated and processed.

ETSI requirement: In ISDNs conforming to this ETS, the Call identity information element will have a special treatment and will be truncated and processed in the case that it exceeds the maximum length implemented.

5.8.8 Data link reset

Whenever a ETS 300 102-1 entity is informed of a spontaneous data link layer reset by means of the DL-ESTABLISH-INDICATION primitive, the following procedures apply:

- a) For calls in the Overlap Sending and Overlap Receiving states, the entity shall initiate clearing by sending a DISCONNECT message with cause #41 "temporary failure", and following the procedures of §5.3.
- b) For calls in the disestablishment phase (states N11, N12, N19, N22, U11, U12, and U19) no action shall be taken.
- c) Calls in the establishment phase (states N1, N3, N4, N6, N7, N8, N9, U1, U3, U4, U6, U7, U8, and U9) and in the Active, Suspend Request and Resume Request states shall be maintained according to the procedures contained in other parts of §5.

5.8.9 Data link failure

Whenever a ETS 300 102-1 entity is notified by its data link entity via the DL-RELEASE-INDICATION primitive that there is a data link layer malfunction, the following procedure shall apply:

- a) The Any calls not in the Active in the Overlap Sending or Overlap Receiving states shall be cleared internally.
- b) For any call without a timer running (see §9) in the Active state, timer T309 shall be started (if implemented).

NOTE: If timer T309 is already running, it shall not be restarted.

- b) The ETS 300 102-1 entity may shall request layer 2 re-establishment by sending a DL-ESTABLISH-REQUEST primitive. if a call is not in the Null state. Otherwise, the Q.931 entity may clear internally.

NOTE 1: If the transfer mode of the call is circuit-mode, the Q.931 entity may clear the calls. If the transfer mode of the call is packet mode and layer 1 is recognized as normal in spite of the data link failure, the Q.931 entity shall not clear the call and shall request data link re-establishment.

When informed of layer 2 re-establishment by means of the DL-ESTABLISH-CONFIRM primitive, the following procedure shall apply:

- 1) Stop timer T309.
- 2) Optionally, a STATUS message with cause #31, "normal, unspecified" shall may also be sent to report the current call state to the peer entity. Alternatively, a STATUS ENQUIRY message can may be sent to verify the call state of the peer entity.

If timer T309 expires prior to data link reestablishment, the network shall: clear the network connection and call to the remote user with cause #27 "destination out of order"; disconnect and release the B-channel; release the call reference and enter the Null state.

When a back-up D-channel is available, the procedures in Annex F may be used.

If timer T309 expires prior to data link reestablishment, the user shall: clear an attached connection (if any) with cause #27 "destination out of order"; disconnect and release the B-channel; release the call reference and enter the Null state.

NOTE 2: The implementation of timer T309 in the user side is optional, and in the network side is mandatory.

5.8.10 Status enquiry procedure

Whenever an entity wishes to check the correctness of a call state at a peer entity, a STATUS ENQUIRY message may be sent requesting the call state. This may, in particular, apply to procedural error conditions described in §§5.8.8 and 5.8.9.

Upon sending the STATUS ENQUIRY message, timer T322 shall be started in anticipation of receiving a STATUS message. While timer T322 is running, only one outstanding request for call state information shall exist. Therefore, if timer T322 is already running, it shall not be restarted. If a clearing message is received before timer T322 expires, timer T322 shall be stopped, and call clearing shall continue.

Upon receipt of a STATUS ENQUIRY message, the receiver shall respond with a STATUS message, reporting the current call state and cause #30 "response to STATUS ENQUIRY" or #97 "message type non-existent or not implemented" (see §5.8.4). Receipt of the STATUS ENQUIRY message does not result in a state change.

ETSI requirement: Cause #30 shall be used when the status enquiry procedure is implemented.

The sending or receipt of the STATUS ENQUIRY message in such a situation will not directly affect the call state of either the sender or receiver. The side having received the STATUS message shall inspect the Cause information element. If the STATUS message contains cause #97 "message type non-existent or not implemented", timer T322 shall continue to time for an explicit response to the STATUS ENQUIRY message. If a STATUS message is received that contains cause #30 "response to STATUS ENQUIRY", timer T322 shall be stopped and the appropriate action taken, based on the information in that STATUS message, relative to the current state of the receiver. If timer T322 expires and a STATUS message with cause #97 "message type non-existent or not implemented" was received, the appropriate action shall be taken, based on the information in that STATUS message, relative to the current state of the receiver.

These further "appropriate actions" are implementation dependent. However, the actions prescribed in the following section shall apply.

If timer T322 expires, and no STATUS message was received, the STATUS ENQUIRY message may be retransmitted one or more times until a response is received. The number of times the STATUS ENQUIRY message is retransmitted as an implementation dependent value. The call shall be cleared to the local interface with cause #41 "temporary failure", if the STATUS ENQUIRY is retransmitted the maximum number of times. If appropriate, the network shall also clear the network connection, using cause #41 "temporary failure".

5.8.11 Receiving a STATUS message

On receipt of a STATUS message reporting an incompatible state, the receiving entity shall:

- a) clear the call by sending the appropriate clearing message with cause #101 "message not compatible with call state"; or,
- b) take other actions which attempt to recover from a mismatch and which are an implementation option.

Except for the following rules, the determination of which states are incompatible is left as an implementation decision:

- a) If a STATUS message indicating any call state except the Null state is received in the Null state, then the receiving entity shall either:
 - 1) send a RELEASE message with cause #101 "message not compatible with call state"; and then follow the procedures of §5.3; or,
 - 2) send a RELEASE COMPLETE message with cause #101 "message not compatible with call state"; and remain in the Null state.
- b) If a STATUS message indicating any call state except the Null state is received in the Release Request state, no action shall be taken.
- c) If a STATUS message, indicating the Null state, is received in any state except the Null state, the receiver shall release all resources and move into the Null state. When in the Null state, the receiver of a STATUS message indicating the Null state shall take no action other than to discard the message and shall remain in the Null state.

A STATUS message may be received indicating a compatible call state but containing one of the following causes:

- a) #96 "mandatory information element is missing";
- b) #97 "message type non-existent or not implemented";
- c) #99 "information element non-existent or not implemented"; or,
- d) #100 "invalid information element contents".

In this case the actions to be taken are an implementation option. If other procedures are not defined, the receiver shall clear the call with the appropriate procedure defined in §5.3, using the cause specified in the received STATUS message.

On receipt of a STATUS message specifying the global call reference and reporting an incompatible state in the Restart Request or Restart state, the receiving ETS 300 102-1 entity shall inform layer management and take no further action on this age.

When in the Null state, then on receipt of a STATUS message with the global call reference no action shall be taken.

NOTE: Further actions as a result of higher layer activity (e.g. system or layer management) are implementation dependent (including the retransmission of RESTART message).

Except for the above case, the error handling procedures when receiving a STATUS message specifying the global call reference are an implementation option.

5.9 User notification procedure

This procedure allows the network to notify a user of the suspension or resumption of the call at the remote user any appropriate call-related event during the Active state of a call. It also allows a user to notify the remote user of any appropriate call-related such an event during the Active state of a call by sending a NOTIFY message containing a notify indicator to the network; upon receipt of this message, the network shall must send a NOTIFY message containing the same notify indicator to the other user involved in the call. No state change occurs at any of the interface sides following the sending or the receipt of this message. It shall be possible for networks and users to receive NOTIFY messages pertaining to supplementary services in other than the Active state.

6 Packet communication procedures

The content of this section is identical to that of ETS 300 007, §6, and therefore is not reproduced in this ETS.

7 User-to user signalling procedures

7.1 Procedures for user-to-user signalling associated with circuit-switched calls

7.1.1 General

The user-to-user signalling supplementary service(s) provides a means of communications between two users by using as a basis the layer 3 protocol defined in §5. User-to-user signalling is used to exchange information between two users to provide the services described in the CCITT Recommendation I.257A. The exchange of user-to-user signalling is limited by flow control procedures provided by the network or the user. The exchange of user-to-user information is not a network acknowledge service. Any acknowledgement procedure shall be controlled at a higher layer between users.

Three user-to-user signalling services associated with circuit-switched calls that may be provided by the network to users are:

- i) Service 1: user-to-user signalling exchanged during the set-up and clearing phases of a call, within Q.931 call control messages;
- ii) Service 2: user-to-user signalling exchanged during call establishment, between the ALERTING and CONNECT messages, within USER INFORMATION messages; and,
- iii) Service 3: user-to-user signalling exchanged while a call is in the Active state, within USER INFORMATION messages.

All three services may be used separately or in any combination in association with a single call. As an option, at call setup, users may be able to specify that the requested user-to-user signalling service(s) is (are) required for the call, i.e. the call should not be completed if user-to-user information cannot be passed.

7.1.2 Explicit invocation procedures for services 1, 2, and 3

Services 1, 2 and 3 listed above may be provided on a per call basis following an explicit request from a user. The standard explicit invocation procedure makes use of the Facility information element defined in §4.

In addition, or alternatively, some networks may support explicit invocation procedures making use of:

- Keypad facility information element.; or
- Feature activation information element.

The exact operation of stimulus invocation procedures are network dependent but must follow the rules defined in §8 of this ETS. More detailed protocol aspects can be found in ETS 300 122 (for the keypad

protocol invocation) and in §5 (for the feature management protocol invocation) of Recommendation Q.932.

When a network supports more than one invocation procedure, the following principles shall be followed:

- for invocations using the Keypad facility information element, the network will convey the remote user's response using a Signal, or a Display or a feature indication information element.
- for invocations using the Feature activation....
- for invocations using the Facility information element, the network will convey the remote user's response using a Facility information element.

In the network to user direction, explicit service 1 and service 2 requests may be indicated using the Facility information element.

In the network to user direction, service 3 requests may be indicated using:

- i) Signal information element (See NOTE),
- ii) Display information element (see NOTE).
- iii) Feature indication information element (see NOTE), or
- iv) Facility information element.

For indications using the Facility information element, the user will respond with a Facility information element. No response is needed when any of the first three the Display information elements are is used.

NOTE: These may be used only when the network has knowledged that the user receiving the notification has subscribed to the service. In this case, the network will generate the service confirmation to the originating user (i.e. the user requesting the service) on behalf of the user who did not originate the service request. For service 3, invoked during the Active state of a call, the message use is symmetric across the user-network interface; i.e. the FACILITY message is returned in response to a FACILITY message.

7.1.3 User-to-User Signalling Service 1

7.1.3.1 General characteristics

Service 1 allows the users to communicate by means of user-to-user signalling by transferring user-to-user information within Q.931 call control messages during call establishment setup and clearing phases.

ETSI requirement: Two methods are defined for requesting service 1: the implicit request and the explicit request method.

A network conforming to this ETS and providing service 1 shall support the implicit service request from users. The support of the explicit service request method in addition to the implicit request method is a network option.

For networks conforming to this ETS supporting the two service request methods the provision of the necessary arrangements to allow communications between users implementing one method and users making use of the other if a network matter.

Networks conforming to this ETS supporting only the implicit service request method shall treat the receipt of an explicit service 1 request according to error handling procedures defined in §5.8.

In the case of the establishment of a call involving interworking between a network supporting both methods and a network supporting the implicit service request method, the originating network shall convert the explicit request to an implicit request at the interworking boundary, providing that the explicit request indicates "preferred". If the explicit service 1 request specifies "required", then the originating network shall reject the request and clear the call. Interworking between implicit and explicit invocation is for further study.

7.1.3.2 User-to-user signalling in the call setup and clearing phases - Implicit service request (preferred, i.e. not required)

Service 1 may be implicitly requested by including a User-user information element of variable length as specified in §4.5.29 in the SETUP message transferred across the user-network interface at the calling side as described in §5.1.1. This information element is transported by the network and delivered unchanged in the User-user information element included in the SETUP message transferred across the user-network interface at the called side as described in §5.2.1. For invocation purposes, this information element must be at least three octets long as defined in §4.5.29.

In the case where contention by users for the incoming call is not allowed (e.g. when the SETUP message containing an implicit service invocation is delivered using a point-to-point link at the data link layer or when the network despite using broadcast capability at layer 2, knows based on the first response received from the user that no contention takes place), a User-user information element may be included in the ALERTING and/or CONNECT messages transferred across the user-network interface at the called side as described in §5.2.5. The content of this information element is transported by the network and delivered in the User-user information element included in the corresponding message(s) transferred across the user-network interface at the calling side as described in §§5.1.7 and 5.1.8.

In the case where users are allowed to contend for an incoming call (e.g. when the SETUP message containing an implicit service invocation is delivered using the broadcast capability at the data link layer and the network is unable to determine based upon the first response received from the user that there is no contention), the User-user information element may be included in the CONNECT message transferred at the called side. The content of the User-user information element delivered to the calling user shall be that received from the selected terminal as described in §5.2.8.

NOTE 1: The user may not be able to interpret incoming user-to-user information. In such situations, the user should discard this information without disrupting normal call handling. No specific signalling is provided by the network to accommodate this situation.

NOTE 2: In accordance with CCITT Recommendation X.213, the called user may perform compatibility checking using the User-user information element contents (see Annex B).

ETSI NOTE: The handling of user-user information elements received in ALERTING messages by the network where users are allowed to contend for an incoming call requires further study.

7.1.3.3 User-to-user signalling in the call establishment setup and clearing phases - Explicit service request (preferred or required)

Procedures for call establishment are as described in §5.1 and §5.2 with the following modifications:

On call request, the SETUP message sent by the calling user shall contain a service 1 request. The SETUP message sent by the network at the called side shall also contain an explicit service 1 request.

In the case where contention by users for the incoming call is not allowed (e.g. when the SETUP is delivered using the point-to-point data link layer or when the SETUP is delivered using the broadcast capability at the data link layer and the network is able to determine that no contention is occurring), and the called user can support the transfer of User-user information elements during the call, a service 1 acceptance shall be included in the ALERTING message.

This explicit service 1 acceptance will be forwarded by the network to the calling user in the ALERTING message.

A User-user information element may be included in the ALERTING message and/or CONNECT message transferred across the user-network interface at the called side as described in §5.2.5.

In accordance with CCITT Recommendation X.213, the called user may perform compatibility checking using the User-user information element contents (see Annex B).

NOTE: On explicit service 1 request, if the network receives a DISCONNECT message with a User-user information element from the originating user before receiving service 1 acceptance from the terminating user, the network shall discard the User-user information element and may send cause #43 "access information discarded" in the subsequent RELEASE message to the originating user.

7.1.3.4 Interworking

In the case of interworking with a non-ISDN network, the return of a PROGRESS or an ALERTING message with the Progress indicator information element indicating #1 "call is not end-to-end ISDN further call progress may be available in-band" to the calling user shall serve as indication that, in particular, the delivery of User-user information elements in call control messages cannot be guaranteed.

7.1.3.5 Rejection of implicit service requests

Networks that cannot provide the service requested will not return a rejection indication.

7.1.3.6 Rejection of explicit service requests

If the called user or network does not understand the service 1 request, then the ALERTING message returned to the calling party shall not include either a service 1 acceptance or rejection. This type of response will be taken as an implicit rejection of service 1.

If the network or called user cannot support service 1, and it was requested as preferred, a service 1 rejection is included in the ALERTING message.

If the service 1 request indicated required and the called user or network cannot support it, a RELEASE COMPLETE is sent with cause #69 "requested facility not implemented" and a service 1 rejection.

If the called user does not include a service 1 acceptance or rejection in the ALERTING message, the network shall return an explicit rejection in the ALERTING message sent to the calling user.

7.1.3.7 User-to-user signalling in the call clearing phase

A User-user information element may be included in the first message used to initiate the normal call clearing phase (see §§5.3.3 and 5.3.4).

The information contained in such an information element is transferred to the remote user in the first clearing message (see §§5.3.3 and 5.3.4). Such a transfer is only performed if the information is received at the local exchange of the remote user before sending a clearing message to that user, otherwise, the information is discarded without sending any notification.

In addition, when a SETUP message has been delivered using the broadcast capability at the data link layer and the network is unable to determine from the first response received from the user that there is no contention, only the following user-to-user information transfer is allowed:

i) in the network to called user direction:

in the case of premature clearing by the calling user, user-to-user information is sent in the first clearing message to each called user that has already responded to the incoming SETUP message;

ii) in the called user-network direction:

the user-to-user information will only be accepted from a terminal which is selected.

If multiple clearing messages are received, the network may, as a network option, retain the User-user information element along with the cause retained according to §5.2.5.4. In the event that this cause is returned to the calling user, the associated User-user information element shall also be returned. If there are multiple clearing messages containing causes of equal priority and User-user information elements, the User-user information element contained in the first clearing message will be sent to the calling user. If any of the clearing messages with the highest priority causes do not contain User-user information element and other clearing messages with causes of lower priority do contain User-user information elements, no User-user information element shall be sent back to the calling user.

In the case where contention by users for the incoming call is not allowed (e.g. when the SETUP message is delivered using the point-to-point data link layer or the network knows that a user responding to a SETUP sent using the broadcast capability at the data link layer is not contending for the call) a User-user information element may be included in the first clearing message sent by the called user prior to entering the active Null state.

In the case where contention by users for the incoming call is not allowed, if the called user rejects the call with a RELEASE COMPLETE message containing user-user information, the network shall deliver the user-user information in the DISCONNECT message sent to the calling user. However, if the network is providing in-band information to the calling user, and chooses not to initiate clearing procedures at that time, the network may deliver the user-to-user information in a PROGRESS message sent to the calling user.

If the network is providing in-band information to the calling user, in conjunction with call clearing, the network shall include the User-user information element in the DISCONNECT message sent to the calling user.

NOTE: It is intended that this capability may be used to provide the clearing data transfer described in CCITT Recommendation X.213.

7.1.3.8 Unexpected user-user information in call control messages

The network shall discard the User-user information element if it is received from either user in an ALERTING, CONNECT, DISCONNECT, RELEASE or RELEASE COMPLETE message but a request for user-user signalling was not indicated (either explicitly or implicitly) in the SETUP message delivered to the user. If this occurs, the network shall take action on the remaining contents of the message received from the user and shall send a STATUS to the user containing cause #43 "access information discarded".

7.1.4 User-to-user signalling service 2

7.1.4.1 General characteristics

Service 2 allows the users to communicate by means of user-to-user signalling by transferring two USER INFORMATION messages in each direction during the call establishment phase. This service allows either an implicit or explicit rejection (see §7.1.4.3).

Service 2 is only applicable when a SETUP message has been delivered using the point-to-point data link layer at the user-network interface at the called side.

7.1.4.2 Call establishment

Procedures for call establishment are as described in §§5.1 and 5.2 with the following modifications:

On call request, the SETUP message sent by the calling user will contain a service 2 request. The SETUP message sent by the network at the called side, will also contain an explicit service 2 request.

If the called user can support USER INFORMATION messages during call establishment, a service 2 acceptance shall be included in the ALERTING message sent to the network. This explicit acceptance indication shall be forwarded in the ALERTING message sent by the network to the calling user.

7.1.4.3 Service rejection

If the called user or network does not understand the service 2 request, then the ALERTING message returned to the calling user will not include either a service 2 acceptance or rejection. This type of response shall be taken as an implicit rejection of service 2. Alternatively, if the network or called user cannot support USER INFORMATION messages during call establishment, and the request is indicated as preferred, a service 2 rejection is included in the ALERTING message.

If the service 2 request indicated required, and the called user or network cannot support or provide the service, a RELEASE COMPLETE is sent with cause #50 "requested facility not subscribed" or cause #69 "requested facility not implemented" and a service 2 rejection.

If the called user does not include a service 2 acceptance or rejection in the ALERTING message, the network shall return an explicit rejection in the ALERTING message sent to the calling user.

In the case of interworking with a non-ISDN network, a PROGRESS or ALERTING message with the progress indicator information element indicating #1 "call is not end-to-end ISDN; further call progress information may be available in-band" is sent to the calling user to indicate that the full service cannot be guaranteed.

7.1.4.4 Transfer of USER INFORMATION messages

Once an ALERTING message has been received, both the involved users can transfer information between themselves by transferring USER INFORMATION messages across the user-network interface. The network provides for the transfer of such messages from the calling to the called side and vice versa.

The USER INFORMATION messages includes the Call reference, the Protocol discriminator, and the User-user information elements as defined in §3.1.23. The More data information element may also be included by the source user to indicate to the remote user that another USER INFORMATION message will follow, containing information belonging to the same block. The use of the More data information element is not supervised by the network.

If the user-to-user signalling facility is provided, no more than two USER INFORMATION messages may be transferred in each direction after the ALERTING message and before the CONNECT message.

Sending or receiving of USER INFORMATION messages does not change the state of the call.

7.1.5 User-to-user signalling service 3

7.1.5.1 General

Service 3 allows the users to communicate by means of transferring USER INFORMATION messages during the Active state of a call. This service allows either an implicit or explicit rejection (see §7.1.5.3). This service may be requested during call establishment or during the Active state of the call.

7.1.5.2 Service request during call establishment

Procedures for call establishment are as described in §§5.1 and 5.2 with the following modifications.

On call request, the SETUP message sent by the calling user will contain a service 3 request. The SETUP sent by the network at the called side will also contain a service 3 request.

If the called user can support USER INFORMATION message transfer during the Active state, a service 3 acceptance shall be included in the CONNECT message.

7.1.5.3 Rejection of service request during call establishment

If the called user or network does not understand the service 3 request, then the CONNECT message returned to the calling user shall not include either a service 3 acceptance or rejection. This type of response will be taken as an implicit rejection of service 3. Alternatively, if the network or called user cannot support USER INFORMATION messages during the Active state, and the request is indicated as preferred, a service 3 rejection is included in the CONNECT message. If the service 3 request indicated required, and the called user or network cannot support or provide the service, a RELEASE COMPLETE message is sent with cause #50 "requested facility not subscribed" or cause #69 "requested facility not implemented" and a service 3 rejection.

If the called user does not include a service 3 acceptance or rejection in the CONNECT message, the network shall return a service 3 rejection in the CONNECT message sent to the calling user.

When interworking with a non-ISDN network occurs a PROGRESS or an ALERTING message with the Progress indicator information element indicating #1 "call is not end-to-end ISDN; further call progress information may be available in-band" is sent to the calling user to indicate that the service cannot be guaranteed.

7.1.5.4 Service request after call establishment

During the Active state of a call, a user may request service 3 preferred only. A FACILITY message indicating a service 3 request is sent from the requesting user to the network. The network shall indicate the service 3 request to the user that did not request service 3 in the FACILITY message.

If the user that did not request service 3 can support the transfer of USER INFORMATION messages during the Active state, a service 3 acceptance is returned in the FACILITY message. This explicit acceptance indication shall be conveyed back to the requesting user in a FACILITY message.

NOTE: On explicit service 3 request during the active phase of the call, if the network receives a USER INFORMATION message with a User-user information element from the originating user before receiving service 3 acceptance from the terminating user, the network shall discard the User-user information element and may send cause #43 "access information discarded" in a STATUS message to the originating user

7.1.5.5 Rejection of service request after call establishment

If the user that did not request service 3 or network does not understand the service 3 request, then no message is returned. This response shall be taken as an implicit rejection of the service request. Alternatively, if the requested user or network cannot support or provide the service requested, a service 3 rejection shall be returned in the FACILITY message.

If the requested user does not respond to the service 3 request, the network shall return a service 3 rejection to the calling user.

7.1.5.6 Transfer of USER INFORMATION messages

Once the call is established, both users can transfer information between themselves by transporting USER INFORMATION messages across the user- network interface. The network provides for the transfer of such messages from the calling to the called side and vice versa.

The USER INFORMATION message includes the Call reference, the Protocol discriminator, and the User-user information elements. The More data information element may also be included by the source user to indicate to the remote user that another USER INFORMATION message will follow, containing information belonging to the same block. The use of the More data information element is not supervised by the network.

7.1.5.7 Congestion control of USER INFORMATION messages

The network or user will provide flow-control, when needed, the transfer of USER INFORMATION messages from a user or network by means of a CONGESTION CONTROL message containing a congestion level information. Two indications of congestion level are specified: "receive not ready" and "receive ready". On receipt of the former, the user or network should suspend sending USER INFORMATION messages; on receipt of the latter, sending may recommence. After having sent a receive not ready indication, the network or user shall discard USER INFORMATION messages which are subsequently received. The network or user will send a CONGESTION CONTROL message with a receive not ready indication whenever a USER INFORMATION message is locally discarded, if it is possible. The CONGESTION CONTROL message shall also include a cause #43 "access information discarded".

The receipt of the receive ready indication shall be interpreted as an indication that no more than "n" USER INFORMATION messages may be sent before another receive ready indication is received. The value of "n" is given in as yet unpublished ETS entitled "ISDN User-to-user Signalling (UUS) - Stage 1 Description" and currently known as T/NA1 (89) 06 requires further study.

Congestion control procedure itself should be regarded as local.

7.1.6 Unexpected USER INFORMATION messages

7.1.6.1 Receipt of USER INFORMATION messages in incompatible call states

Whenever a USER INFORMATION message is received from the user and it is not allowed by an invoked service (e.g. in any other state than Active where only service 3 is invoked), the message will be discarded by the network. The network will respond with a STATUS message with a cause #43 "access information discarded".

7.1.6.2 Receipt of unexpected USER INFORMATION messages

Whenever a USER INFORMATION message is received by the network from the calling or called user after the network has indicated that user-to-user signalling cannot be supported, that message shall be discarded without further action.

7.1.7 Requesting user-to-user signalling services 1, 2 and 3

7.1.7.1 General

This section describes procedures for requesting services 1, 2 and 3 in the same SETUP message. These services are described in §§7.1.3, 7.1.4 and 7.1.5 respectively.

NOTE: User-to-user service 1 implicit request/acceptance follows §7.1.3.2 procedures. Only explicit service 1 requests may follow the procedure in this section.

7.1.7.2 Call establishment

Procedures for call establishment are described in §§7.1.3.3, 7.1.4.2 and 7.1.5.2 with the following modifications. On call request, the SETUP message sent by the calling user will contain independent services 1, 2 and 3 requests.

The SETUP message sent by the network at the called side will also contain the same independent service requests. If the called user can support the indicated services, then specific service acceptances may all be indicated in the ALERTING message. Alternatively, the user may accept services 1 and 2 in the ALERTING message, as defined in §§7.1.3.3 and 7.1.4.2 and service 3 in the CONNECT message as defined in §7.1.5.2.

7.1.7.3 Service rejection

If the called user or network does not understand any of the services requested, then the ALERTING and CONNECT messages returned to the calling user will not include either a service acceptance or rejection.

This type of response will be taken as an implicit rejection of all services. If the called user or network does not understand a specific service request, that specific service is implicitly rejected following the procedures defined in §§7.1.3.6, 7.1.4.3 or 7.1.5.3. Alternatively, if the network or called user cannot support one or more services requested, and the service requests were indicated as preferred, the specific services rejection may be included in the ALERTING message. The services may also be rejected following the procedures in §§7.1.3.6, 7.1.4.3 or 7.1.5.3.

If the called user does not include a service 1, 2 or 3 acceptance or rejection in the ALERTING and/or CONNECT message, the network shall return a service 1, 2 or 3 rejection in the ALERTING and/or CONNECT message sent to the calling user.

When interworking with a non-ISDN network occurs a PROGRESS or an ALERTING message with the Progress indicator information element indicating #1 "call is not end-to-end ISDN, further call progress information may be available in-band" is sent to the calling user to indicate that the service cannot be guaranteed.

If any one or all of the services requested is indicated as required, then the network or called user that cannot support or provide the request will send a RELEASE COMPLETE message with cause #50 "requested facility not subscribed" or cause #69 "requested facility not implemented" and the service rejection associated with that service.

7.1.7.4 Transfer of USER INFORMATION messages

The transfer of USER INFORMATION messages is defined in §§7.1.4.4 and 7.1.5.6.

7.1.8 Summary of actions to be taken by the called side and subsequent network action

Actions to be taken by the called side and the subsequent network actions are summarised in the following table.

Table 7.1: Actions to be taken at the called side (NOTE 1)

Case	Called User's Capability	Requested Service (NOTE 2)	Called User Action	Calling User Network Interface Action
1	Can analyze the service and accepts the service	Services 1, 2,3. Preferred or Required	Return appropriate ACK indication by the response message	Passes ACK to the calling user in normal call control message
2	Can analyse the service but does not accept the service	Services 1, 2, 3 Required	Clears the call with appropriate message and cause	Passes same cause to the calling user in the normal call control clearing message
		Services 1 (explicit invocation) 2,3 Preferred	Return appropriate NACK indication in the response message The call is not cleared	Passes NACK back to the calling user in normal call control messages. The call is not cleared
		Service 1 (implicit invocation) Preferred	Ignore the request or return appropriate NACK indication by the response message, the call is not cleared	Passes NACK to the calling user
3	Cannot analyze the service request	1, 2, 3 Required	Treats as an unrecognised optional information element	Clears the call with appropriate message and cause
		Services 1, 2, 3 Preferred	Treats as an unrecognised optional information element	Passes back the implicit user response to the calling node (NOTE 3)

NOTE 1: This table covers the point-to-point case. In the point-to-multipoint case, it is applied only if no contention to a broadcast SETUP message exists.

NOTE 2: When an implicit user-to-user signalling invocation is received for service 1 (which means that the User-user information element is included in the SETUP message but the explicit invocation is not), the request is regarded as preferred.

NOTE 3: When no indication of acceptance or rejection of requested service is received from the called user, then it is regarded as an implicit service rejection. Therefore, in service 1 the User-user information element carried by originating SETUP message is not guaranteed an acknowledgement. The action to be taken in this case is up to the calling user.

ETSI NOTE:

Key:

ACK: Acknowledgement indicating the acceptance of the invoked service. In case of the explicit acknowledgement ACK takes the form of a Return Result component in a Facility information element. In case of the implicit acceptance (only applicable to service 1) it takes the form of a User-user information element, which may be empty. Stimulus information elements (e.g. Signal and Display) may also be appropriate, when the stimulus procedures are supported by the network, at the calling user interface.

NACK: Negative acknowledgement indicating the explicit rejection of the invoked service. NACK takes the form of a Return Error component included in a Facility information element. Stimulus information elements (e.g. Signal and Display) may also be appropriate, when the stimulus procedures are supported by the network, at the calling user interface.

7.2 Procedures for user-to-user signalling not associated with circuit-switched calls

ETSI Requirement: The procedures for user-to-user signalling not associated with circuit switched calls is outside the scope of this issue of this ETS.

8 Application of circuit-switched supplementary services to terminals using stimulus procedures.

The contents of this section have not been reproduced as they are contained in as yet unpublished ETS entitled "ISDN DSS1 Generic keypad protocol for the support of supplementary services" and currently known as ETS 300 122.

9 List of system parameters

The description of timers in the following tables should be considered a brief summary. The precise details are found in §§5 and 6, which should be considered the definitive descriptions.

9.1 Timers in the Network Side

The timers specified in table 9.1 are maintained in the network side of the interface.

9.2 Timers in the User side

The timers specified in table 9.2 are maintained in the user side of the interface. Timers T305, T308, and T313 are mandatory for all user side implementations.

Table 9.1 (1 of 3): Timers in the network side

Timer number	Default time-out value	State of call	Cause for start	Normal stop	At the first expiry	At the second expiry	Cross reference
T301	Minimum 3 min	Call Received	ALERTING received.	CONNECT received.	Clear the call	Timer is not restarted.	NOTE 2
T302	10-15s NOTE 5	Overlap Sending	SETUP ACK sent. Receipt of INFO restarts T302	With sending complete indication, or network alert, or connect request received	Clear if call information determined to be definitely incomplete; else send CALL PROC.	Timer is not restarted.	Mandatory
T303	4 s NOTE 1	Call Present	SETUP sent	ALERTING, CONNECT, CALL PROC, or SETUP ACK received. REL COMPLETE received if SETUP sent on point- point data link.	Retransmit SETUP; restart T303. If REL COMP has been received, clear the call.	Clear network connection. Enter Call Abort state.	Mandatory
T304	20 s	Overlap Receiv.	SETUP ACK received. sending of INFO restarts T304.	Send INFO; receive CALL PROC, ALERTING or CONNECT.	Clear the call.	Timer is not restarted	Mandatory only if § 5.2.4 is implemented.
T305	30 s	Disconn. Indicat.	DISCONNECT without progress indicator #8 sent	RELEASE or DISCONNECT received.	Network sends RELEASE	Timer is not restarted	Mandatory
T306	30 s NOTE 6	Disconn. Indicat.	DISCONNECT with progress indicator #8 sent.	RELEASE or DISCONNECT received.	Stop the tone/ announcement. Send RELEASE	Timer is not restarted.	Mandatory when in band ton/announc. are provided §5.4, 5.3.4.1 and Rec. I.300 series

Table 9.1 (2 of 3): Timers in the network side

Timer number	Default time-out value	State of call	Cause for start	Normal stop	At the first expiry	At the second expiry	Cross reference
T307	3 min	Null	SUSPEND ACKNOWLEDGE sent.	RESUME received.	Clear the network connection. Release call identity.	Timer is not restarted.	Mandatory
T308	4 s NOTE 1	Release Request.	RELEASE sent.	RELEASE COMPLETE or RELEASE received.	Retransmit RELEASE and restart T308.	Place B-channel in maintenance condition. Release call refer. NOTE 9	Mandatory
T309	90 s	Any stable state.	Data Link disconnection. Calls in stable states are not lost	Data link reconnected.	Clear network connection. Release B-channel and call reference.	Timer is not restarted.	Mandatory
T310	10 s 30-40 s NOTE 7	Incoming Call Proceed.	CALL PROCEEDING received.	ALERT, CONN, PROGRESS or DISC received. If DISC, retain cause and continue timing	Clear the call in accordance with § 5.2.5.3.	Timer is not restarted.	Mandatory
T312	T303 + 2 s	Call Present, Call Abort, etc.	SETUP sent or resent on broadcast data link.	Timeout.	NOTE 4.	Timer is not restarted	Mandatory
T314	4 s	Receiving segmented message	Message segment received.	Last message segment received.	Discard message	Timer is not restarted.	Mandatory see Annex K
T316	2 min	Restart Request.	RESTART sent.	RESTART ACKNOWLEDGE received.	RESTART may be retransmitted several times.	RESTART may be retransmitted several times.	Mandatory when §5.5 is implemented.
T317	NOTE 3	Restart	RESTART received.	Internal clearing of call references	Maintenance notification	Timer is not restarted.	Mandatory when §5.5 is implemented.

Table 9.1 (3 of 3): Timers in the network side

Timer number	Default time-out value	State of call	Cause for start	Normal stop	At the first expiry	At the second expiry	Cross reference
T320	30 s NOTE 8	B-chann. access: Active D-chann. access: Null	B-channel access: CONNECT sent or received. D-channel access: DL-ESTABLISH-CONFIR or DL-ESTABLISH-INDIC received. Last logical channel cleared.	Call Request packet received; or Incoming Call packet delivered; or DISC received; or for D-channel access DL-REL-IND received	B-channel access: disconnect link layer and initiate clearing. D-channel access: send DL-RELEASE-REQUEST	Timer is not restarted.	Optional, see §6.3.
T321	30 s	Any Call state.	D-channel failure.	Response to layer message received.	Send DL-ESTABLISH-REQ on both D-channels	Timer is not restarted.	Mandatory when Annex F is implemented
T322	4 s	Any Call State	STATUS ENQUIRY sent.	STATUS, DISCONNECT, RELEASE or RELEASE COMPLETE received.	STATUS ENQUIRY may be retransmitted several times	STATUS ENQ. may be retransmitted several times	Mandatory when §5.8.10 is implemented

NOTE 1: This default value assumes the use of default values at layer 2 (ie., (N200 + 1) times T200). Whether these values should be modified when layer 2 values are modified by an automatic negotiation procedure is for further study.

NOTE 2: The network may already have applied an internal alerting supervision timing function; eg, incorporated within call control. If such a function is known to be operating on the call, then timer T301 is not used.

NOTE 3: The value of this timer is implementation dependent but should be less than the value of T316.

NOTE 4: If in the Call Abort state, the call reference is released. Otherwise, no action is taken on expiry of timer T312.

NOTE 5: The value of timer T302 may vary beyond these limits; eg., as a result of called party number analysis.

NOTE 6: The value of timer T306 may depend on the length of the announcement.

NOTE 7: The value of timer T310 may be different in order to take into account the characteristics of a private network.

NOTE 8: This value may vary by network-user agreement.

NOTE 9: The restart procedures contained in §5.5 may be used on B-channels in the maintenance condition.

Table 9.2 (1 of 3): Timers in the user side

Timer number	Default time-out value	State of call	Cause for start	Normal stop	At the first expiry	At the second expiry	Cross reference
T301	Minimum 3 min	Call Deli- vered.	ALERTING received.	CONNECT received.	Clear the call	Timer is not restarted.	Mandatory when Annex D is implemented NOTE 3.
T302	15 s	Overlap Receiv.	SETUP ACK sent. Restart when INFO received.	INFO received with sending complete indication, or internal alerting; or internal connection; or determination that sufficient call information has been received.	Clear if call information determined to be incomplete; else send CALL PROC.	Timer is not restarted.	Mandatory only if §5.2.4 is implemented
T303	4 s NOTE 1	Call Initiat.	SETUP sent	ALERTING (Annex D), CONNECT (Annex D), SETUP ACK, CALL PROC., or RELEASE COMPLETE received.	Retransmit SETUP; restart T303. If REL COMP has been received, clear the call. (Annex D)	Clear internal connection. Send REL COMP. Enter Null state.	Mandatory when Annex D is implemented Otherwise optional.
T304	15 s 30 s	Overlap Sending	INFO sent. Restarted when INFO sent again. SETUP ACK received. Sending of INFO restarts T304.	CALL PROCEEDING, ALERTING, CONNECT or DISCONNECT received.	DISCONNECT sent.	Timer is not restarted.	Optional
T305	30 s	Disconn. Request.	DISCONNECT sent.	RELEASE or DISC received.	RELEASE sent.	Timer is not restarted	Mandatory

Table 9.2 (2 of 3): Timers in the user side

Timer number	Default time-out value	State of call	Cause for start	Normal stop	At the first expiry	At the second expiry	Cross reference
T308	4 s NOTE 1	Release Request	RELEASE sent.	RELEASE COMPLETE or RELEASE received.	Retransmit RELEASE; restart T308.	Place B-channel in maintenance condition. Release call refer. NOTE 5	Mandatory
T309	90 s	Any stable state.	Data link disconnection. Calls in stable states are not lost	Data link reconnected	Clear internal connection. Release B-channel and call reference.	Timer is not restarted.	Optional
T310 NOTE 4	10 s > 40 s	Outgoing Call Proceed.	CALL PROCEEDING received.	ALERTING, CONNECT, DISCONNECT or PROGRESS received.	Send DISCONNECT.	Timer is not restarted.	Mandatory when Annex D is implemented
T313	4 s NOTE 1	Connect Request	CONNECT sent.	CONNECT ACKNOWLEDGE received.	Send DISCONNECT.	Timer is not restarted.	Mandatory
T314	4 s	Receiving segmented message.	Message segment received.	Last message segment received.	Discard message.	Timer is not restarted	Mandatory see Annex K.
T316	2 min	Restart Request	RESTART sent.	RESTART ACKNOWLEDGE received.	RESTART may be retransmitted several times.	RESTART may be retransmitted several times.	Mandatory when §5.5 is implemented
T317	NOTE 2	Restart	RESTART received.	Internal clearing of call references	Maintenance notification.	Timer is not restarted.	Mandatory when §5.5 is implemented

Table 9.2 (3 of 3): Timers in the user side

Timer number	Default time-out value	State of call	Cause for start	Normal stop	At the first expiry	At the second expiry	Cross reference
T318	4 s	Resume request	RESUME sent.	RESUME ACKNOWLEDGE or RESUME REJECT received	Clear internal connection. Release call reference. Enter Null state.	Timer is not restarted.	Mandatory when §5.6 is implemented.
T319	4 s	Suspend request.	SUSPEND sent.	SUSPEND ACKNOWLEDGE or SUSPEND REJECT received.	Enter Active state. Notify user application.	Timer is not restarted.	Mandatory when §5.6 is implemented.
T321	30 s	Any call state.	D-channel failure	Response to layer message received.	Send DL-ESTABLISH REQUEST. On both D-channels.	Timer is not restarted.	Mandatory when Annex F is implemented.
T322	4 s	Any call state	STATUS ENQUIRY sent.	STATUS, DISCONNECT, RELEASE or RELEASE COMPLETE received.	STATUS ENQUIRY may be retransmitted several times.	STATUS ENQ may be retransmitted several times.	Mandatory when §5.8.10 is implemented.

NOTE 1: This default value assumes the use of default values at layer 2 (i.e. (N200 + 1) times T200). Whether these values should be modified when layer 2 values are modified by an automatic negotiation procedure is for further study.

NOTE 2: The value of this timer is implemented dependent but should be less than the value of T316.

NOTE 3: The user may already have applied an internal alerting supervision timing function; eg., incorporated within call control. If such a function is known to be operating on the call, then timer T301 is not used.

NOTE 4: T310 is not started if progress indicator #1 or #2 has been delivered in the CALL PROCEEDING message or in a previous PROGRESS message.

NOTE 5: The restart procedures contained in §5.5 may be used on B-channels in the maintenance condition.

Annex A (Informative): User side and network side SDL diagrams

The content of this Annex is identical to that of ETS 300 102-2, and therefore is not reproduced in this ETS.

Annex B (Normative): Compatibility checking

B.1 Introduction

This annex describes the various compatibility checks which should be carried out to ensure that the best match of user and network capabilities is achieved on a call within an ISDN.

This annex also covers interworking with existing networks.

Three different processes of compatibility checking shall be performed:

- i) at the user-to-network interface on the calling side (see §B.2);
- ii) at the network-user interface on the called side (see §B.3.2); and,
- iii) user-to-user (see §B.3.3)

NOTE: In this context and throughout this annex the term "called user" is the end point entity which is explicitly addressed. This may be an addressed interworking unit (IWU); see I.500 series CCITT Recommendations.

For details on the coding of the information required for compatibility checking, see Annex L.

B.2 Calling side compatibility checking

At the calling side, the network shall check that the bearer service requested by the calling user in the Bearer capability information element matches with the bearer services provided to that user by the network. If a mismatch is detected, then the network shall reject the call using one of the causes listed in §5.1.5.2.

Network services are described in CCITT Recommendations I.230 and I.240 as bearer services and teleservices respectively.

B.3 Called side compatibility checking

In this section, the word "check" means that the user examines the contents of the specified information element.

B.3.1 Compatibility checking with addressing information

If an incoming SETUP message is offered with addressing information (i.e. either DDI or subaddressing or the appropriate part of the called party number, e.g. for DDI) the following actions will occur:

- a) If a number (e.g. for DDI) or subaddress is assigned to a user, then the information in a Called party number or Called party subaddress information element of the incoming call shall be checked by the user against the corresponding part of the number assigned to the user (e.g. for DDI) or the user's own subaddress. In the case of a mismatch, the user shall ignore the call. In the case of a match, the compatibility checking described in §B.3.2 to §B.3.3 will follow;
- b) If a user has no assigned DDI-number or subaddress, then the Called party number and Called party subaddress information elements shall be ignored. The compatibility checking described in §B.3.2 and §B.3.3 will follow.

NOTE 1: According to user's requirements, compatibility checking can be performed in various ways from the viewpoint of execution order and information to be checked e.g. first assigned DDI number/subaddress and then compatibility or vice versa.

NOTE 2: If an incoming call, offered with addressing information, is always to be awarded to the addressed user, all users connected to the same passive bus should have an assigned DDI-number or subaddress.

B.3.2 Network-to user compatibility checking

When the network is providing a bearer service at the called side, the user shall check that the bearer service offered by the network in the Bearer capability information element matches the bearer services that the user is able to support. If a mismatch is detected, then the user shall either ignore or reject the offered call using the cause #88 "incompatible destination".

B.3.3 User-to-user compatibility checking

The called side terminal equipment shall check that the content of the Low layer compatibility information element is compatible with the functions it supports.

The Low layer compatibility information element (if available) shall be used to check compatibility of low layers (e.g. from layer 1 to layer 3, if layered according to the OSI model).

NOTE: The Bearer capability information element is also checked, see §B.3.2. Therefore, if any conflict from duplication of information in the Bearer capability and the Low layer compatibility information elements is detected, this conflict shall be resolved according to Annex L; e.g. the conflicting information in the Low layer compatibility information element shall be ignored.

If the Low layer compatibility information element is not included in an incoming SETUP message, the Bearer capability information element shall be used to check the compatibility of low layers.

The called terminal equipment may check the High layer compatibility information element (if present) as part of user-to-user compatibility checking procedures, even if the network only supports bearer services.

Some terminal equipment, upon bilateral agreement with other users or in accordance with other standards (e.g. Recommendation X.213), may employ the user-user information element for additional compatibility checking. Such terminal equipment shall check the User-user information element in a manner identical to that described here for the High layer compatibility information element "compatibility assured" case.

If a mismatch is detected in checking any of the information elements above, then the terminal equipment shall either ignore or reject the offered call using cause #88 "incompatible destination".

With regard to the presence or absence of the High layer compatibility and Low layer compatibility information elements, two cases arise:

a) Compatibility assured with the available description of the call

This is when all terminal equipment implement (i.e. understand the contents of) the High layer compatibility and Low layer compatibility information elements. Thus, based on the High layer compatibility and Low layer compatibility information element encoding, they are capable of accepting a call for which they have the requested functionality.

b) Compatibility not assured with the available description of the call

This is when all or some of the terminal equipment do not recognise (i.e. ignore) either the High layer compatibility or Low layer compatibility information elements. Without careful configuration or administration at the user's installation, there is danger that a terminal equipment which has incorrect functionality will accept the call.

Therefore, in order to assure compatibility with incoming call, it is recommended that the terminal equipment check the Low layer compatibility and High layer compatibility information elements.

NOTE: Some terminal equipment, upon bilateral agreement with other users or in accordance with other standards (e.g. Recommendation X.213), may employ the User-user information element for additional compatibility checking. Such terminal equipment shall check the User-user information element in a manner identical to that described here for the High layer compatibility information element "compatibility assured" case.

B.3.4 User action tables

The following tables show the action which shall be carried out as a result of compatibility checking with the calling user's request for a bearer service and/or teleservice.

Table B.1: Bearer capability compatibility checking

BC mandatory info element	Point-to-point data link	Broadcast data link (NOTE 1)	
Compatible	Proceed	Proceed	
Incompatible	Reject (§5.2.5.1)	Ignore (§5.2.5.1.a) (NOTE 2)	Reject (§5.2.5.1.b) (NOTE 2)

Table B.2: Low layer and high layer compatibility checking: compatibility assured with the available description of the call

LLC/HLC compatibility assured	Point-to-point data link (NOTE 1)		Broadcast data link (NOTE 1)		
Compatible	Accept		Accept		
Incompatible	Reject 5.2.5.1	Attempt LLC negotiation Annex M	Ignore 5.2.5.1.a (NOTE 2)	Reject 5.2.5.1.b (NOTE 2)	Attempt LLC neg. (Annex M)

Table B.3: Low layer and high layer compatibility checking: compatibility not assured with the available description of the call

LLC/HLC compatibility not assured	Point-to-point data link (NOTE 1)		Broadcast data link (NOTE 1)	
LLC or HLC present	Accept or reject (NOTE 3)	Attempt LLC negotiation (Annex M)	Accept or reject (NOTE 3)	Attempt LLC negotiation (Annex M)

NOTE 1: For broadcast data link terminal equipment which is explicitly addressed using subaddressing or the appropriate part of the called party number DDI, the point-to-point column in the above table shall be used.

NOTE 2: When a terminal equipment on a broadcast data link is incompatible, an option of "ignore or reject" is permitted, see §5.2.2.

NOTE 3: Some terminal equipment on this interface may understand the High layer or Low layer compatibility information element and would reject the call if incompatible.

B.4 Interworking with existing networks

Limitations in network or distant user signalling (e.g. in the case of an incoming call from the PSTN or a call from an analogue terminal) may restrict the information available to the called user in the incoming SETUP message. A called user should accept limited compatibility checking (e.g. without the High layer compatibility information element) if a call is routed from an existing network which does not support High layer compatibility information element transfer.

In cases where the network cannot provide all incoming call information or where the network is not aware of the existence or absence of some service information (such as compatibility information), the incoming SETUP message includes a Progress indicator information element containing progress indicator No.1 "Call is not end-to-end ISDN, further call progress information may be available in band" or No.3 "Origination address is non-ISDN" (see Annex I).

The terminal equipment receiving a SETUP message with a Progress indicator information element shall modify its compatibility checking, the terminal equipment should regard the compatibility as successful if it is compatible with the included information, which as a minimum, will be the Bearer capability information element. A terminal equipment expecting information in addition to the Bearer capability information element in a full ISDN environment need not reject the call if such information is absent but a Progress indicator information element is included.

Annex C (Normative): Transit network selection

This annex describes the processing of the Transit network selection information element.

C.1 Selection not supported

Some networks may not support transit network selection. In this case, when a Transit network selection information element is received, that information element is processed according to the rules for unimplemented non-mandatory information elements (see §5.8.7.1).

C.2 Selection supported

When transit network selection is supported, the user identifies the selected transit network(s) in the SETUP message. One Transit network selection information element is used to convey a single network identification.

The user may specify more than one transit network. Each identification is placed in a separate information element. The call would then be routed through the specified transit networks in the order listed in the SETUP message. For example, a user lists networks A and B, in that order, in two Transit network selection information elements within a SETUP message. The call is first routed to network A (either directly or indirectly), and then to network B (either directly or indirectly), before being delivered.

As the call is delivered to each selected network, the corresponding transit network selection may be stripped from the call establishment signalling, in accordance with the relevant internetwork signalling arrangement. The Transit network selection information element(s) is/are not delivered to the destination user.

No more than four Transit network selection information elements may be used in a single SETUP message.

When a network cannot route the call because the route is busy, the network shall initiate call clearing in accordance with §5.3 with cause #34 "no circuit/channel available".

If a network does not recognise the specified transit network, the network shall initiate call clearing in accordance with §5.3, with cause #2 "no route to specified transit network". The diagnostic field shall contain a copy of the contents of the "Transit network selection information element identifying the unreachable network".

A network may screen all remaining Transit network selection information elements to:

- a) avoid routing loops, or
- b) ensure that an appropriate business relationship exists between selected networks, or
- c) ensure compliance with national and local regulations.

If the transit network selection is of an incorrect format, or fails to meet criterion (a), (b), or (c), the network shall initiate call clearing in accordance with §5.3, with cause #91 "invalid transit network selection".

When a user includes the Transit network selection information element, pre-subscribed default transit network selection information (if any) is overridden.

Annex D (Informative): Extension for symmetric call operation

This annex is for information. ECMA standard QSIG-BC specifies the ISPBX-to-ISPBX basic call control in the context of private network application.

D.1 Additional message handling

In symmetric applications, the SETUP message will contain a Channel identification information element indicating a particular B-channel to be used for the call. A point-to-point data link shall be used to carry the SETUP message.

The procedures described in §5 for the user side should normally be following. Where additional procedures are required, they are detailed below.

D.1.1 B-channel selection - symmetric interface

Only B-channels controlled by the same D-channel will be the subject of the selection procedure. The selection procedure is as follows:

- a) The SETUP message will indicate one of the following:
 - 1) channel is indicated, no acceptable alternative; or
 - 2) channel is indicated, any alternative is acceptable.
- b) In cases 1) and 2), if the indicated channel is acceptable and available, the recipient of the SETUP message reserves it for the call. In case 2), if the recipient of the SETUP message cannot grant the indicated channel, it reserves any other available B-channel associated with the D-channel.
- c) If the SETUP message included all information required to establish the call, the recipient of the SETUP message indicates the selected B-channel in a CALL PROCEEDING message transferred across the interface and enters the Incoming Call Proceeding state.
- d) If the SETUP message did not include all information required to establish the call, a B-channel is indicated in a SETUP ACKNOWLEDGE message sent across the interface. The additional call establishment information, if any, is sent in one or more INFORMATION messages transferred across the interface in the same direction as the SETUP message. When all call establishment information is received, a CALL PROCEEDING, ALERTING, or CONNECT message, as appropriate is transferred across the interface.
- e) In case 1) if the indicated B-channel is not available, or in case 2) if no B-channel is available a RELEASE COMPLETE message, with a cause value of #44 "requested circuit/channel not available" or #34 "no circuit/channel available" respectively, is returned to the initiator of the call. The sender of this message remains in the Null state.

- f) If the channel indicated in the CALL PROCEEDING or SETUP ACKNOWLEDGE message is unacceptable to the initiator of the call, the initiator clears the call in accordance with §5.3.

D.1.2 Call confirmation

Upon receipt of a SETUP message, the equipment enters the Call Present state. Valid responses to the SETUP message are a SETUP ACKNOWLEDGE, an ALERTING, a CALL PROCEEDING, a CONNECT or a RELEASE COMPLETE message.

If the indicated channel is acceptable to the initiator of the call, the initiator shall attach to the indicated B-channel.

D.1.3 Clearing by the called user employing user provided tones/announcements

In addition to the procedures described in §5.3.3, if the bearer capability is either audio or speech, the called user or private network may apply in-band tones/announcements in the clearing phase. When in-band tones/announcements are provided, the DISCONNECT message contains progress indicator #8 "in-band information or appropriate pattern is now available" and the called user or private network proceeds similarly as stipulated in §5.3.4.1 for the network.

D.1.4 Active indication

Upon receipt of a CONNECT message, the initiator of the call shall respond with a CONNECT ACKNOWLEDGE message and enter the Active state.

D.2 Timers for call establishment

User endpoints implement the network side timers T301, T303, and T310 along with the corresponding network side procedures for actions taken upon expiration of these timers. See table 9.2 for the call establishment user- side timers and procedures.

D.3 Call collisions

In symmetric arrangements, call collisions can occur when both sides simultaneously transfer a SETUP message indicating the same channel. In the absence of administrative procedures for assignment of channels to each side of the interface, the following procedure is employed.

First, one side of the interface will be designated the "network" and the other side of the interface will be designated the "user". Second, for the three possible scenarios where the same channel is indicated by combinations of preferred and exclusive from the user and network sides, the following procedure is used:

- a) "network" preferred, "user" preferred:

The "network" preferred channel is awarded and an alternate channel is indicated in the first response to the "user" SETUP message.

- b) "network" exclusive, "user" exclusive:

The "network" exclusive channel is awarded and the "user" SETUP message is cleared with a RELEASE COMPLETE message with cause #34 "no circuit/channel available".

- c) "network" preferred, "user" exclusive; or "network" exclusive, "user" preferred:

The side of the interface with an exclusive indicator in a SETUP message is awarded the channel and an alternate channel is indicated in the first response to the side using a preferred indicator in the SETUP message.

Channel identification is allowed in both directions for ALERTING and CONNECT message.

Annex E (Normative): Network specific facility selection

This Annex describes the processing of the Network-specific facilities information element. The purpose of this information element is to indicate which network facilities are being invoked.

E.1 Default provider

When the length of the network identification field is set to zero in the Network-specific facilities information element, then the services identified in this information element are to be provided by the network side of the interface receiving the information element (default provider). If the Network-specific facilities information element is recognised but the network facilities are not understood, then this information element is processed according to rules for non-mandatory information element content error (see §5.8.7.2).

E.2 Routing not supported

Some networks may not support the routing to the remote network of the contents of the Network-specific facilities information element. In this case, when a Network-specific facilities information element is received, that information element is processed according to the rules for unimplemented non-mandatory information elements (see §5.8.7.1).

E.3 Routing supported

When Network-specific facility information element routing is supported, the user identifies the network provider in this information element in the ETS 300 102-1 SETUP message. One Network-specific facility information element is used to identify a network provider.

The user may specify more than one network provider by repeating the Network-specific facilities information element. Each identification is placed in a separate information element. The information is route to the indicated network provider as long as the call is also handled by the network provider (see Annex C, Transit network selection). For example, if the user lists network providers A and B in separate Network-specific facilities information elements in a call control message, there must be corresponding Transit network selection information elements in the SETUP message identifying those networks (or default call routing via A and B that was established prior to call establishment).

As the signalling messages containing Network-specific facilities information elements are delivered to the indicated remote network, they may be stripped from the signalling messages, in accordance with the relevant internetworking signalling arrangement. The Network-specific facilities information elements may be delivered to the identified user.

No more than four Network-specific facilities information elements may be used in a SETUP message. When the information element is repeated, the order of presentation of the elements in a message is not significant. Further, there does not have to be a one-to-one correspondence between Network-specific facility information elements and Transit network selection information elements.

If a network cannot pass the information to the indicated network provider, either due to:

- The network indicated is not part of the call path, or
- No mechanism exists for passing the information to identified network

the network shall initiate call clearing in accordance with §5.3, with cause #2 "no route to specified transit network". The diagnostic field may optionally contain a copy of the first 5 octets of the network-specific facilities information element.

When a user includes the Network-specific facilities information element in the SETUP message, pre-subscribed default service treatment (if any) is overridden.

Annex F (Informative): D-Channel backup procedures

ETSI NOTE: This Annex is not applicable in ISDNs conforming to this ETS.

Annex G (Informative): Cause definitions

This annex provides definitions to the causes in §4.5.12. A table is provided in Appendix I to indicate how these causes are used in the call control procedures.

G.1 Normal class

G.1.1 Cause #1 "unallocated (unassigned) number"

This cause indicates that the destination requested by the calling user cannot be reached because, although the number is in a valid format, it is not currently assigned (allocated).

G.1.2 Cause #2 "no route to specifies transit network"

This cause indicates that the equipment sending this cause has received a request to route the call through a particular transit network which it does not recognise. The equipment sending this cause does not recognise the transit network either because the transit network does not exist or because that particular transit network, while it does exist, does not service the equipment which is sending this cause.

This cause is supported on a network-dependent basis.

G.1.3 Cause #3 "no route to destination"

This cause indicates that the called user cannot be reached because the network through which the call has been routed does not serve the destination desired.

This cause is supported on a network-dependent basis.

G.1.4 Cause #6 "channel unacceptable"

This cause indicates the channel most recently identified is not acceptable to the sending entity for use in this call.

G.1.5 Cause #7 "call awarded and being delivered in an established channel"

This cause indicates that the user has been awarded the incoming call, and that the incoming call is being connected to a channel already established to that user for similar calls (e.g. packet-mode X.25 virtual calls).

G.1.6 Cause #16 "normal call clearing"

This cause indicates that the call is being cleared because one of the users involved in the call has requested that the call be cleared.

Under normal situations, the source of this cause is not the network.

G.1.7 Cause #17 "user busy"

This cause is used when the called user has indicated the inability to accept another call.

It is noted that the user equipment is compatible with the call.

G.1.8 Cause #18 "no user responding"

This cause is used when a user does not respond to a call establishment message with either an alerting or connect indication within the prescribed period of time allocated (defined in ETS 300 102-1 by the expiry of either timer T303 or T310).

G.1.9 Cause #19 "no answer from user (user alerted)"

This cause is used when a user has provided an alerting indication but has not provided a connect indication within a prescribed period of time.

NOTE: This cause is not necessarily generated by ETS 300 102-1 procedures but may be generated by internal network timers.

G.1.10 Cause #21 "call rejected"

This cause indicates that the equipment sending this cause does not wish to accept this call, although it could have accepted the call because the equipment sending this cause is neither busy nor incompatible.

G.1.11 Cause #22 "number changed"

This cause is returned to a calling user when the called party number indicated by the calling user is no longer assigned. The new called party number may optionally be included in the diagnostic field. If a network does not support this capability, cause #1 "unallocated (unassigned) number" shall be used.

G.1.12 Cause #26 "non-selected user clearing"

This cause indicates that the user has not been awarded the incoming call.

G.1.13 Cause #27 "destination out of order"

This cause indicates that the destination indicated by the user cannot be reached because the interface to the destination is not functioning correctly. The term "not functioning correctly" indicates that a signalling message was unable to be delivered to the remote user; e.g. a physical layer or data link layer failure at the remote user, user equipment off-line, etc.

G.1.14 Cause #28 "invalid format (address incomplete)"

This cause indicates that the called user cannot be reached because the called party number is not in a valid format or is not complete.

G.1.15 Cause #29 "facility rejected"

This cause is returned when a facility requested by the user cannot be provided by the network.

G.1.16 Cause #30 "response to status enquiry"

This cause is included in the STATUS message when the reason for generating the STATUS message was the prior receipt of a STATUS ENQUIRY message.

G.1.17 Cause #31 "normal, unspecified"

This cause is used to report a normal event only when no other cause in the normal class applies.

G.2 Resource unavailable class

G.2.1 Cause #34 "no circuit/channel available"

This cause indicates that there is no appropriate circuit/channel presently available to handle the call.

G.2.2 Cause #38 "network out of order"

This cause indicates that the network is not functioning correctly and that the condition is likely to last a relatively long period of time; e.g. immediately re-attempting the call is not likely to be successful.

G.2.3 Cause #41 "temporary failure"

This cause indicates that the network is not functioning correctly and that the condition is not likely to last a long period of time; e.g. the user may wish to try another call attempt almost immediately.

G.2.4 Cause #42 "switching equipment congestion"

This cause indicates that the switching equipment generating this cause is experiencing a period of high traffic.

G.2.5 Cause #43 "access information discarded"

This cause indicates that the network could not deliver access information to the remote user as requested; i.e. a user-to-user information, low layer compatibility, high layer compatibility, or subaddress as indicated in the diagnostic.

It is noted that the particular type of access information discarded is optionally included in the diagnostic.

G.2.6 Cause #44 "requested circuit/channel not available"

This cause is returned when the circuit or channel indicated by the requesting entity cannot be provided by the other side of the interface.

G.2.7 Cause #47 "resource unavailable, unspecified"

This cause is used to report a resource unavailable event only when no other cause in the resource unavailable class applies.

G.3 Service or option not available class

G.3.1 Cause #49 "quality of service not available"

This cause is used to report that the requested quality of service, as defined in CCITT Recommendation X.213, cannot be provided, (e.g. throughput or transit delay cannot be supported).

G.3.2 Cause #50 "requested facility not subscribed"

This cause indicates that the requested supplementary service could not be provided by the network because the user has not completed the necessary administrative arrangements with its supporting network.

G.3.3 Cause #57 "bearer capability not authorised"

This cause indicates that the user has requested a bearer capability which is implemented by the equipment which generated this cause but the user is not authorised to use.

G.3.4 Cause #58 "bearer capability not presently available"

This cause indicates that the user has requested a bearer capability which is implemented by the equipment which generated this cause but which is not available at this time.

G.3.5 Cause #63 "service or option not available "unspecified"

This cause is used to report a service or option not available event only when no other cause in the service or option not available class applies.

G.4 Service or option not implemented class

G.4.1 Cause #65 "bearer capability not implemented"

This cause indicates that the equipment sending this cause does not support the bearer capability requested.

G.4.2 Cause #66 "channel type not implemented"

This cause indicates that the equipment sending this cause does not support the channel type requested.

G.4.3 Cause #69 "requested facility not implemented"

This cause indicates that the equipment sending this cause does not support the requested supplementary service.

G.4.4 Cause #70 "only restricted digital information bearer capability is available"

This cause indicates that one equipment has requested an unrestricted bearer service but that the equipment sending this cause only supports the restricted version of the requested bearer capability.

G.4.5 Cause #79 "service or option not implemented, unspecified"

This cause is used to report a service or option not implemented event only when no other cause in the service or option not implemented class applies.

G.5 Invalid message (e.g. parameter out of range) class

G.5.1 Cause #81 "invalid call reference value"

This cause indicates that the equipment sending this cause has received a message with a call reference which is not currently in use on the user- network interface.

G.5.2 Cause #82 "identified channel does not exist"

This cause indicates that the equipment sending this cause has received a request to use a channel not activated on the interface for a call. For example, if a user has subscribed to those channels on a primary rate interface numbered from 1 to 12 and the user equipment or the network attempts to use channels 13 through 23, this cause is generated.

G.5.3 Cause #83 "a suspended call exists, but this call identity does not"

This cause indicates that a call resume has been attempted with a call identity which differs from that in use for any presently suspended call(s).

G.5.4 Cause #84 "call identity in use"

This cause indicates that the network has received a call suspend request. The call suspend request contained a call identity (including the null call identity) which is already in use for a suspended call within the domain of interfaces over which the call might be resumed.

G.5.5 Cause #85 "no call suspended"

This cause indicates that the network has received a call resume request. The call resume request contained a Call identity information element which presently does not indicate any suspended call within the domain of interfaces over which calls may be resumed.

G.5.6 Cause #86 "call having the requested call identity has been cleared"

This cause indicates that the network has received a call resume request. The call resume request contained a Call identity information element which once indicated a suspended call; however, that suspended call was cleared while suspended (either by network timeout or by the remote user).

G.5.7 Cause #88 "incompatible destination"

This cause indicates that the equipment sending this cause has received a request to establish a call which has low layer compatibility, high layer compatibility, or other compatibility attributes (e.g. data rate) which cannot be accommodated.

G.5.8 Cause #91 "invalid transit network selection"

This cause indicates that a transit network identification was received which is of an incorrect format as defined in Annex C.

G.5.9 Cause #95 "invalid message, unspecified"

This cause is used to report an invalid message event only when no other cause in the invalid message class applies.

G.6 Protocol error (e.g. unknown message) class

G.6.1 Cause #96 "mandatory information element is missing"

This cause indicates that the equipment sending this cause has received a message which is missing an information element which must be present in the message before that message can be processed.

G.6.2 Cause #97 "message type non-existent or not implemented"

This cause indicates that the equipment sending this cause has received a message with a message type it does not recognise either because this is a message not defined or defined but not implemented by the equipment sending this cause.

G.6.3 Cause #98 "message not compatible with call state or messages TYPE NON-EXISTENT OR NOT IMPLEMENTED"

This cause indicates that the equipment sending this cause has received a message such that the procedures do not indicate that this is a permissible message to receive while in the call state, or a STATUS message was received indicating an incompatible call state.

G.6.4 Cause #99 "information element non-existent or not implemented"

This cause indicates that the equipment sending this cause has received a message which includes information elements not recognised because the information element identifier is not defined or it is defined but not implemented by the equipment sending the cause. However, the information element is not required to be present in the message in order for the equipment sending the cause to process the message.

G.6.5 Cause #100 "invalid information element contents"

This cause indicates that the equipment sending this cause has received an information element which it has implemented; however, one or more of the fields in the information element are coded in such a way which has not been implemented by the equipment sending this cause.

G.6.6 Cause #101 "message not compatible with call start"

This cause indicates that a message has been received which is incompatible with the call state.

G.6.7 Cause #102 "recovery on timer expiry"

This cause indicates that a procedure has been initiated by the expiry of a timer in association with ETS 300 102-1 error handling procedures.

G.6.8 Cause #111 "protocol error, unspecified"

This cause is used to report a protocol error event only when no other cause in the protocol error class applies.

G.7 Interworking class

G.7.1 Cause #127 "interworking, unspecified"

This cause indicates that there has been interworking with a network which does not provide causes for actions it takes; thus, the precise cause for a message which is being sent cannot be ascertained.

Annex H (Informative): Examples of information elements coding

This annex gives examples on the detailed coding of the following information elements:

- Bearer capability information element
- Channel identification information element
- Called/calling party subaddress information element

H.1 Bearer capability information element

H.1.1 Coding for speech

8	7	6	5	4	3	2	1	Octet
0	0	0	0	0	1	0	0	1
Bearer capability Information element identifier								
0	0	0	0	0	0	1	1	2
Length								
1 ext	0	0	0	0	0	0	0	3
CCITT		Speech						
1 ext	0	0	1	0	0	0	0	4
Circuit mode		64 kbit/s						
1 ext	0	1	0	0	0	1	0	5
Layer 1		G.771 μ -law or G.711 A-law						

H.1.2 Coding for 3.1 kHz audio

8	7	6	5	4	3	2	1	Octet
0	0	0	0	0	1	0	0	1
Bearer capability Information element identifier								
0	0	0	0	0	0	1	1	2
Length								
1 ext	0	0	1	0	0	0	0	3
CCITT		3.1 kHz audio						
1 ext	0	0	1	0	0	0	0	4
Circuit mode		64 kbit/s						
1 ext	0	1	0	0	0	1	0	5
Layer 1		G.771 μ -law or G.711 A-law						

H.1.3 Coding for unrestricted digital information

Type 1: Synchronous 64 kbit/s working.

8	7	6	5	4	3	2	1	Octet
0	0	0	0	0	1	0	0	1
Bearer capability Information element identifier								
0	0	0	0	0	0	1	0	2
Length								
1 ext	0	0	0	1	0	0	0	3
CCITT		Unrestricted digital information						
1 ext	0	0	1	0	0	0	0	4
Circuit mode		64 kbit/s						

Type 2: Synchronous rates less than 64 kbit/s with CCITT rate adaption V.110/X.30; in band negotiation not possible.

8	7	6	5	4	3	2	1	Octet
0	0	0	0	0	1	0	0	1
Bearer capability Information element identifier								
0	0	0	0	0	1	0	0	2
Length								
1 ext	0	0	0	1	0	0	0	3
CCITT		Unrestricted digital information						
1 ext	0	0	1	0	0	0	0	4
Circuit mode		64 kbit/s						
1 ext	0	1	0	0	0	0	1	5
Layer 1		Rate adaption						
1 ext	0	0	User rate					5a
Synchr.		Negot						

H.1.4 Coding for case B X.31 packet mode access connections

8	7	6	5	4	3	2	1	Octet
0	0	0	0	0	1	0	0	1
Bearer capability Information element identifier								
0	0	0	0	0	1	0	0	2
Length								
1 ext	0	0	0	1	0	0	0	3
CCITT		Unrestricted digital information						
1 ext	1	0	0	0	0	0	0	4
Packet mode								
1 ext	1	0	0	0	1	1	0	6
Layer 2		X.25 Link layer						
1 ext	1	1	0	0	1	1	0	7
Layer 3		X.25 Packet layer						

H.2 Channel identification information element

H.2.1 Basic interface, circuit mode, B-channel

Example (a)

8	7	6	5	4	3	2	1	Octet
0	0	0	1	1	0	0	0	1
Channel identification Information element identifier								
0	0	0	0	0	0	0	1	2
Length								
1 ext	0 Int.id. present	0 Interf. type	0 Spare	0 Pref/ excl.	0 D-chan. ident.	0	1 Channel selection	3

- Channel B1 preferred
- Channel is located in the same interface which includes the D-channel

Example (b)

8	7	6	5	4	3	2	1	Octet
0	0	0	1	1	0	0	0	1
Channel identification Information element identifier								
0	0	0	0	0	0	0	1	2
Length								
1 ext	0 Int.id. present	0 Interf. type	0 Spare	0 Pref/ excl.	0 D-chan. ident.	1	1 Channel selection	3

- Any B-channel

H.2.2 Primary rate interface, circuit mode, B-channel

Example (a)

8	7	6	5	4	3	2	1	Octet
0	0	0	1	1	0	0	0	1
Channel identification Information element identifier								
0	0	0	0	0	0	1	1	2
Length								
1 ext	0 Int.id. present	1 Interf. type	0 Spare	0 Pref/ excl.	0 D-chan. ident.	0	1 Channel selection	3
1 ext	0 Coding standard	0 No./map	0	0	0	1	1	3.2
Channel type/map type								
1	0	0	0	0	0	0	1	3.3
Channel number/slot map								

- The channel is a B-channel
- The indicated channel is preferred
- The channel is located in the same interface which includes the D-channel
- The channel is identified by channel number

Example (b). (Not applicable in networks conforming to this ETS)

8	7	6	5	4	3	2	1	Octet	
0	Channel identification Information element identifier						0	0	1
0	0	0	0	0	1	0	1	2	
Length									
1 ext	0 Int.id. present	1 Interf. type	0 Spare	0 Pref/ excl.	0 D-chan. ident.	0	1	3	
1 ext	0 Coding standard	0 No./map	1	0 Channel type/map type		1	1	3.2	
0	0	0	0	0	0	0	0	3.3.1	
Channel number/slot map									
0	0	0	0	0	0	0	0	3.3.2	
0	0	0	0	0	0	0	0	3.3.3	

- The channel is a B-channel
- The indicated channel is preferred
- The channel is located in the same interface which includes the D-channel
- The channel is identified by slot map (1544 Kbit/s primary rate interface)

Example (c)

8	7	6	5	4	3	2	1	Octet	
0	Channel identification Information element identifier						0	0	1
0	0	0	0	0	0	0	1	2	
Length									
1 ext	0 Int.id. present	1 Interf. type	0 Spare	0 Pref/ excl.	0 D-chan. ident.	1	1	3	
Channel selection									

- The channel is any B-channel
- The indicated channel is preferred
- The channel is located in the same interface which includes the D-channel

H.2.3 Primary rate interface, circuit mode, H0-channel

8	7	6	5	4	3	2	1	Octet	
0	Channel identification Information element identifier						0	0	1
0	0	0	0	0	0	1	1	2	
Length									
1 ext	0 Int.id. present	1 Interf. type	0 Spare	0 Pref/ excl.	0 D-chan. ident.	0	1	3	
1 ext	0	0	0	0	1	1	0	3.2	
Coding standard No./map Channel type/map type									
1	0	0	0	0	0	0	1	3.3	
Channel number/slot map									

- The channel is the H0-channel number zero
- The indicated channel is preferred
- The channel is located in the same interface which includes the D-channel
- The channel is identified by channel number

Example (b). (Not applicable in networks conforming to this ETS)

8	7	6	5	4	3	2	1	Octet	
0	Channel identification Information element identifier						0	0	1
0	0	0	0	0	0	1	1	2	
Length									
1 ext	0 Int.id. present	1 Interf. type	0 Spare	0 Pref/ excl.	0 D-chan. ident.	0	1	3	
1 ext	0	0	1	0	1	1	0	3.2	
Coding standard No./map Channel type/map type									
0	0	0	0	0	0	1	0	3.3	
Channel number/slot map									

- The channel is the H0-channel
- The indicated channel is preferred-The channel is located in the same interface which includes the D-channel
- The channel is identified by slot map

Example (c). (Not applicable in networks conforming to this ETS)

8	7	6	5	4	3	2	1	Octet	
0	Channel identification 0 1 1 0						0	0	1
Information element identifier									
0	0	0	0	0	1	0	1	2	
Length									
1 ext	0 Int.id. present	1 Interf. type	0 Spare	0 Pref/ excl.	0 D-chan. ident.	0	1	3	
Channel selection									
1 ext	0 Coding	0 standard	1 No./map	0	0	1	1	3.2	
Channel type/map type									
0	0	0	0	0	0	0	1	3.3.1	
Channel number/slot map									
0	1	1	0	1	0	0	1	3.3.2	
0	1	0	0	0	0	0	0	3.3.3	

- The channels are B-channels (6 B-channels to form a H0-channel)
- The indicated channels is preferred
- The channel is located in the same interface which includes the D-channel
- The channel is identified by slot map (1544 kbit/s primary rate interface)

Example (d)

8	7	6	5	4	3	2	1	Octet	
0	Channel identification 0 1 1 0						0	0	1
Information element identifier									
0	0	0	0	0	0	1	0	2	
Length									
1 ext	1 Int.id. present	1 Interf. type	0 Spare	0 Pref/ excl.	0 D-chan. ident.	1	1	3	
Channel selection									
1 ext	0	0	0	0	0	0	0	3.1	
Interface identifier									

- Any channel
- Any interface (interface identifier present = "1" and interface identifier = all "0")

H.2.4 Channel selection for the support of the 2x64 kbit/s bearer service (ETSI networks)

H.2.4.1 Basic interface, circuit mode, 2x64 kbit/s bearer service

8	7	6	5	4	3	2	1	Octet	
0	Channel identification 0 1 1 0						0	0	1
Information element identifier									
0	0	0	0	0	0	0	1	2	
Length									
1 ext	0 Int.id. present	0 Interf. type	0 Spare	X Pref/ excl.	X D-chan. ident.	X	X	3	
Channel selection									

X: Not relevant, any coding permitted.

H.2.4.2 Primary rate interface, circuit mode, 2x64 kbit/s bearer service

8	7	6	5	4	3	2	1	Octet
Channel identification								1
0	0	0	1	1	0	0	0	Information element identifier
Length								2
0	0	0	0	0	1	0	0	
1	0	1	0	0	0	0	1	3
ext	Int.id. present	Interf. type	Spare	Pref/excl.	D-chan. ident.	Channel selection		
1	0	0	1	0	0	1	1	3.2
ext	Coding standard		No./map	Channel type/map type				
0	0	0	0	0	0	0	1	3.3.1
0	0	0	0	0	0	1	0	3.3.2

- The channels are B-channels (e.g. channels 1 and 2)
- The indicated channels are preferred
- The channel is located in the same interface which includes the D-channel
- The channels are identified by channel number

H.3 Called/calling party subaddress information element

H.3.1 Coding of IA5 subaddress digits

8	7	6	5	4	3	2	1	Octet
Called party subaddress								1
0	1	1	1	0	0	0	1	Information element identifier
Length								2
0	0	0	0	0	1	0	1	
1	0	0	0	Odd/eve (NOTE4)	0	0	0	3
ext	NSAP X.213/ISO 8348 AD2		Spare					
0	1	0	1	0	0	0	0	4
AFI (NOTE 1)								
IA5 character (NOTE 2)								5
IA5 character								6
IA5 character								7

NOTE 1: AFI code hexadecimal 50 indicates that the subaddress consists of IA5 characters (see ISO standard 8348 AD2).

NOTE 2: IA5 character according to CCITT Recommendation T.50/ISO 646.

NOTE 3: The number of IA5 characters shown above is just an example. There may be up to 19 IA5 characters.

NOTE 4: The value of this bit has no significance when the type of subaddress is "NSAP".

Annex I (Normative): Use of progress indicators

This annex describes the use of the different progress indicator values defined in §4.5.22. Examples of use are given.

Progress indicator #1 indicates that interworking with a non-ISDN has occurred within the network or networks through which the call has traversed.

Progress indicator #2 indicates that the destination user is not ISDN.

Progress indicator #3 indicates that the origination user is not ISDN.

Progress indicator #4 indicates that a call which had left the ISDN has returned to the ISDN at the same point it had left due to a redirection within the non-ISDN. This progress indicator would be employed when a prior Recommendation Q.931 message resulted in a progress indicator #1 "call is not end-to-end ISDN" being delivered to the calling user.

The use of progress indicators #1, #2, and #3 is exemplified in the following.

Three interworking situations are identified in the figure below:

- a) interworking with another network;
- b) interworking with a non-ISDN user connected to ISDN; and,
- c) interworking with non-ISDN equipment within the calling or called user's premises.

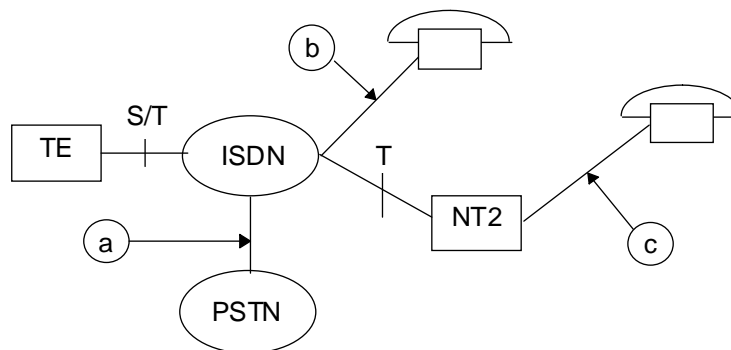

As regards calls from A the following applies:

- case a) - progress indicator #1 sent to A
- case b) - progress indicator #2 sent to A
- case c) - progress indicator #2 sent to A (location subfield=private network)

As regards calls towards A the following applies:

- case a) - progress indicator #1 sent to A
- case b) - progress indicator #3 sent to A
- case c) - progress indicator #3 sent to A (location subfield = private network)

The use of progress indicator #8 "in-band information or appropriate pattern now available" is described in §5.

Annex J (Normative): Examples of cause value and location for busy condition

This Annex gives examples on the detailed cause value and location to be sent in a Cause information element for the busy condition.

Figure J-1 shows the reference configuration which identifies nodes where busy condition may occur and therefore a cause should be generated.

Table J-1 shows:

- a) a cause value and location to be generated at the point where the busy condition occurs; and,

- b) a cause value and location to be delivered to the user (indicated as A) for each location (B-P) where the busy condition occurs).

As is indicated in the table, the cause value is not changed. The network may optionally check and, if necessary, change the location but the location may be changed in the receiving exchange when the cause value it crosses a network boundary.

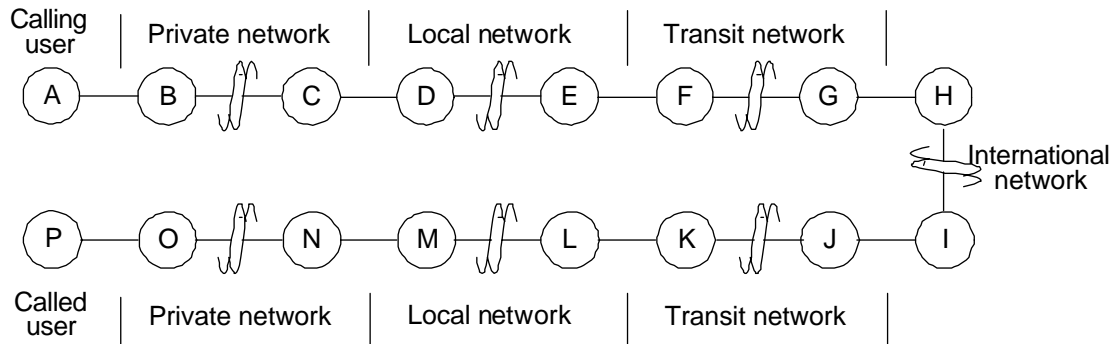

NOTE: The interfaces A-B, C-D, M-N and O-P are assumed to be ETS 300 102-1

Figure J.1: Examples of cause values and location for busy condition

Table: Location where busy occurs and the cause coding

Location where busy occurs	Cause at the point of generation (NOTE)	Cause received by user A
B Incoming circuit	#34 or #44 LPN	The same as left
B Outgoing circuit	#34 LPN	"
C Outgoing circuit	#34 LPN	"
D Incoming circuit	#34 or #44 LN	"
D Outgoing circuit	#34 LN	"
E Outgoing circuit	#34 LN	"
F Outgoing circuit	#34 TN	"
G Outgoing circuit	#34 TN	"
H Outgoing circuit	#34 INTL	"
I Outgoing circuit	#34 INTL	"
J Outgoing circuit	#34 TN	#34 TN
K Outgoing circuit	#34 TN	#34 TN
L Outgoing circuit	#34 RLN	#34 RLN
M Outgoing circuit	#17 RLN	#17 RLN
N Incoming circuit	#34 or #44 LRPN	#34 or #44 RPN
N Outgoing circuit	#34 LRPN	#34 RPN
O Outgoing circuit	#17 LRPN	#17 RPN
P Incoming circuit	#34 or #44 U	#34 or #44 U
P Call control	#17 U	#17 U

NOTE: will also be delivered to user A

- LPN: Private network serving the local user
- LN: Public network serving the local user
- TN: Transit network
- INTL: International transit network
- RLN: Public network serving the remote user
- RPN: Private network serving the remote user
- U: User

Table J-I is for further study.

Annex K (Normative): Message segmentation procedures

K.1 Introduction

Layer 3 messages that are longer than the length of frames that the data link layer can support may be partitioned into several segments.

Message segmentation shall only be used when the message length exceeds N.201 (defined in ETS 300-125). These procedures are optional and may be not supported by all equipment.

ETSI NOTE: Not all ISDNs conforming to this ETS will support this procedure.

The architectural relationship to ETS 300 102-1 functions is shown in figure K-1. These procedures apply only within a specific data link connection and do not impact the procedures in operation on other parallel data link connections.

K.2 Message segmentation

The following rules apply when ETS 300 102-1 messages are to be segmented for transmission:

- a) the default maximum number of messages segments is eight. If the message is too long to be segmented then a local maintenance activity shall be notified;
- b) the first message segment shall begin with the Protocol discriminator information element immediately followed by the Call reference information element, the segment message type, the Segmented message information element, and octets starting with the first octet following the message type of the message being segmented, subject to the maximum length of the segment not exceeding the maximum size of the Data link layer information field and one or more other information elements;
- c) each subsequent message segment shall begin with the Protocol discriminator information element immediately followed by the Call reference information element, the segment message type, the Segmented message information element, and one or more octets of the message being segmented, following directly on from the octets transmitted in the previous segment, subject to the maximum length of the segment not exceeding the maximum size of the Data link layer information field other information elements.
- d) the first segment indicator field of the Segmented message information element shall be set to indicate the first segment of a segmented message, and not set in any other segment;
- e) the number of segments remaining field of the Segmented message information element shall be set to indicate how many more segments are to be sent, see figure K-2;f)the Message type information element shall be coded to indicate a segment message, and the Segmented message information element shall indicate the message type of the original message;
- g) the transmission of a segmented message may be aborted by: sending a message or message segment containing a different call reference; sending a message with the message type not coded "segment message" or stopping the transmission of subsequent message segments pertaining to the same message;
- h) once the first segment has been transmitted on a particular data link connection, then all remaining segments of that message shall be sent (in order) before any other message (segmented or not) for any other call reference is sent on that data link connection;
- i) messages shall be segmented only at information element boundaries; i.e. no information element shall be separated into two segments;
- i.j) the octet information element order of as a whole is preserved for the segmented message shall be preserved regardless of segment boundary.

K.3 Reassembly of segmented messages

The following rules apply to the receipt and reassembly of segmented ETS 300 102-1 messages:

- a) a reassembly function, on receiving a message segment containing the Segmented message information element with the first segment indicator indicating "first message", and containing the call reference and message type (coded as "segment message") information elements shall enter the Receiving Segmented Message state and accumulate message segments;
- b) timer T314, shall be initialized or re-initialized upon receipt of a message segment containing the Segmented message information element with a non-zero number of segments remaining field. Timer T314 shall be stopped upon receipt of the last segment; i.e. a message segment containing the segmented message information element with the number of segments remaining field coded zero. Timer T314 shall not be initialized or re-initialized if error procedures as identified in rules below are initiated.
- c) a reassembly function receiving a message segment with a Segmented message information element should wait for receipt of the last message segment pertaining to the same message; i.e. containing the Segmented message information element with the number of segments remaining field coded zero before delivering the message for further ETS 300 102-1 processing as specified in §5.8. The reassembly function shall enter the Null state.
- d) upon expiry of timer T314, the reassembly function shall; discard all segments of this message so far received; notify the layer 3 management entity for the data link connection that message segments have been lost; and enter the Null state.

NOTE: Subsequent message segments relating to the same message shall be discarded according to rule (f).

- e) a reassembly function, upon receiving eight message segments of the same segmented message without receiving a message segment with a number of segments remaining field of the Segmented message information element coded zero, shall: discard all message segments so far received; notify the layer 3 management entity for the data link connection that messages have been discarded; and enter the Null state.

NOTE: Subsequent message segments relating to the same message shall be discarded according to rule (f).

- f) a reassembly function, on receiving a message segment containing a Segmented message information element, but with no Call reference or Message type information element, while in the Null state shall discard that message segment and remain in the Null state.
- g) a reassembly function, on receiving a message segment containing a Segmented message information element, while in the Receiving Segmented Message state with the number of segments remaining field that is not decremented from the number of segments remaining field in the Segmented message information element of the previous message segment, shall: discard all segments of this message so far received; notify the layer 3 management entity for the data link connection that messages have been discarded; and enter the Null state.

NOTE: Subsequent segments relating to the same message shall be discarded according to rule (f).

- h) if there is a DL-RELEASE-INDICATION primitive or DL-ESTABLISH- INDICATION primitive received while in the Receiving Segmented Message state, the reassembly function shall: discard all message segments so far received; forward the DL-RELEASE-INDICATION primitive or FL-ESTABLISH-INDICATION primitive for further ETS 300 102-1 processing; and enter the Null state.

- i) a reassembly function, upon receiving a message segment with the first segment indicator of the Segmented message information element indicating "subsequent", while in the Null state, shall: discard that message segment; notify the layer 3 management entity for the data link connection that messages have been discarded; and remain in the Null state.

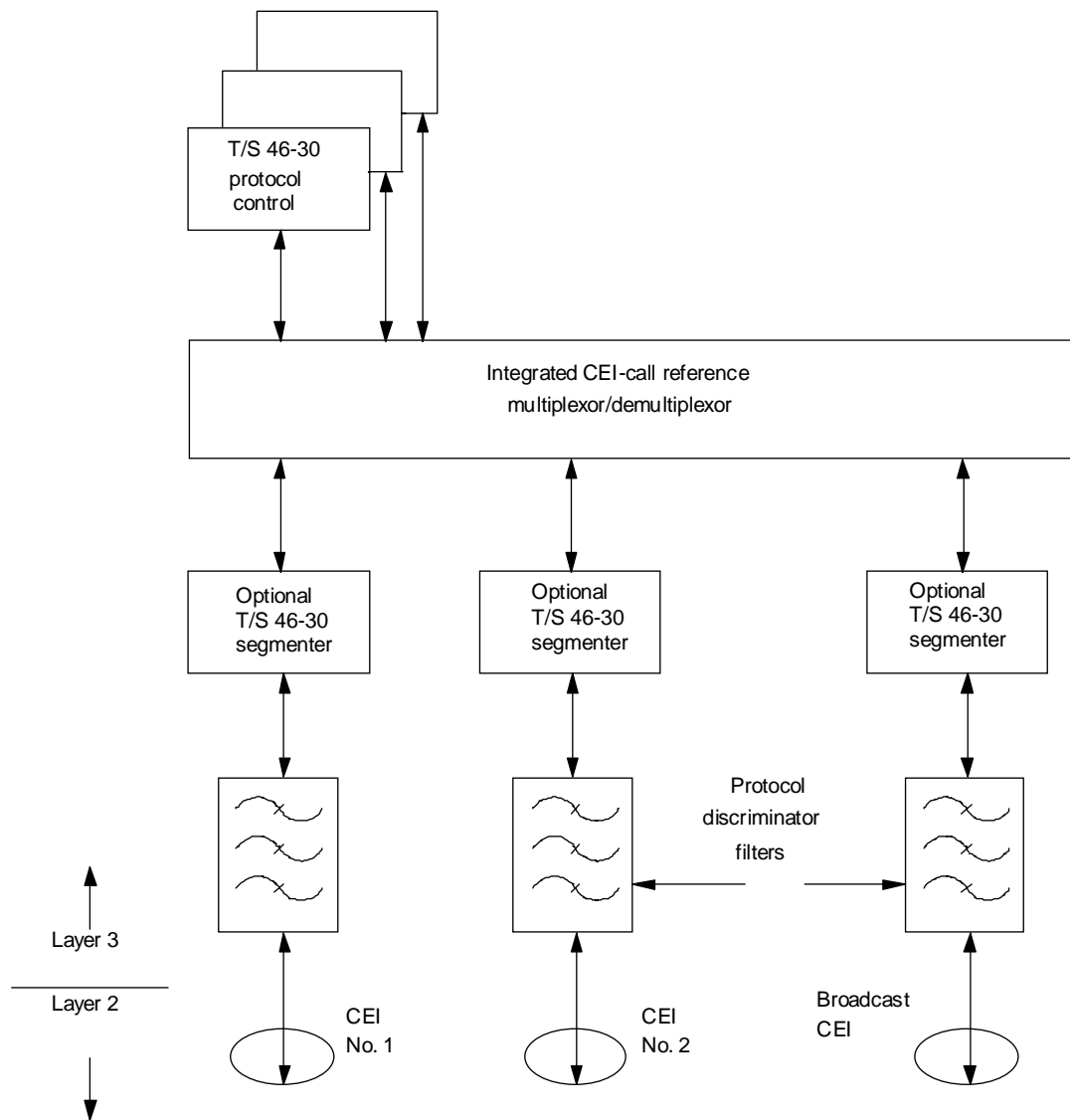

Figure K.1: Logical architecture containing segmentation function

BEFORE SEGMENTATION

Protocol Discriminator
Call Reference
Message Type = A
IE No. 1
.
.
IE No. k
IE No. k + 1
.
.
IE No. z
IE no. z + 1
.
.
IE No. m

AFTER SEGMENTATION

Protocol Discriminator
Call Reference
Message type = Segment
Segment message (1st, N-1, A)
IE No. 1
.
.
IE No. k

Protocol Discriminator
Call Reference
Message Type = Segment
Segment message (subseq, N-2, A)
IE No. k+1
.
.
IE No. z

Protocol Discriminator
Call Reference
Message type = Segment
Segment message (subsequent, 0, A)
IE No. z+1
.
.
IE No. m

Abbreviations

IE: Information Element

Figure K.2: Relationship between messages and segments

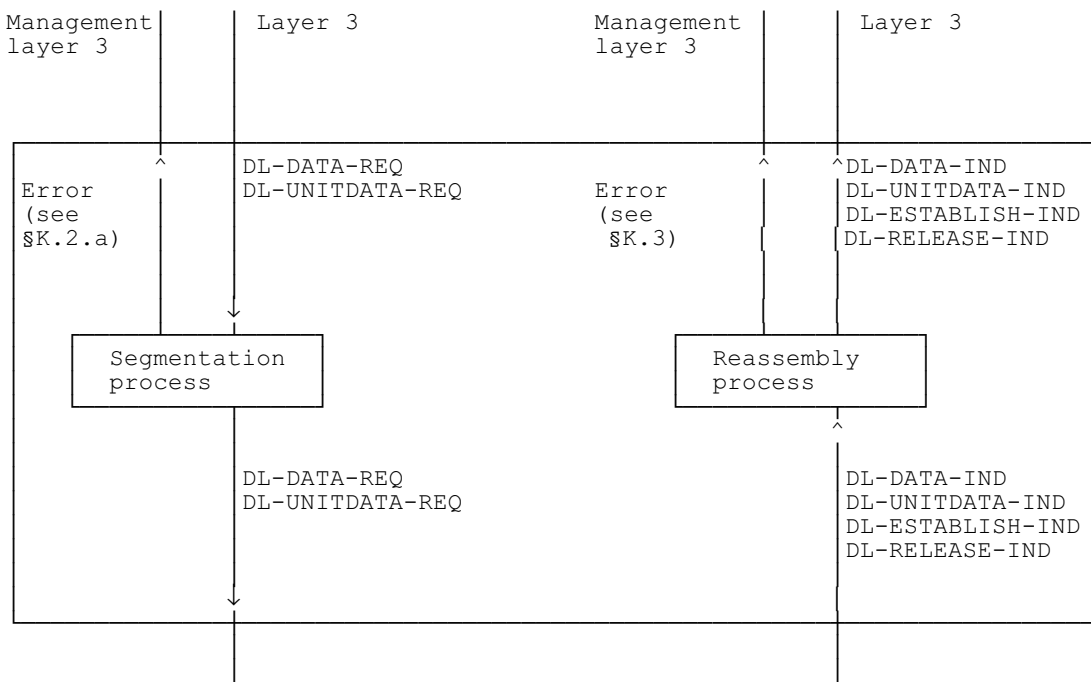

Figure K.3: Segmentation functional interaction diagram

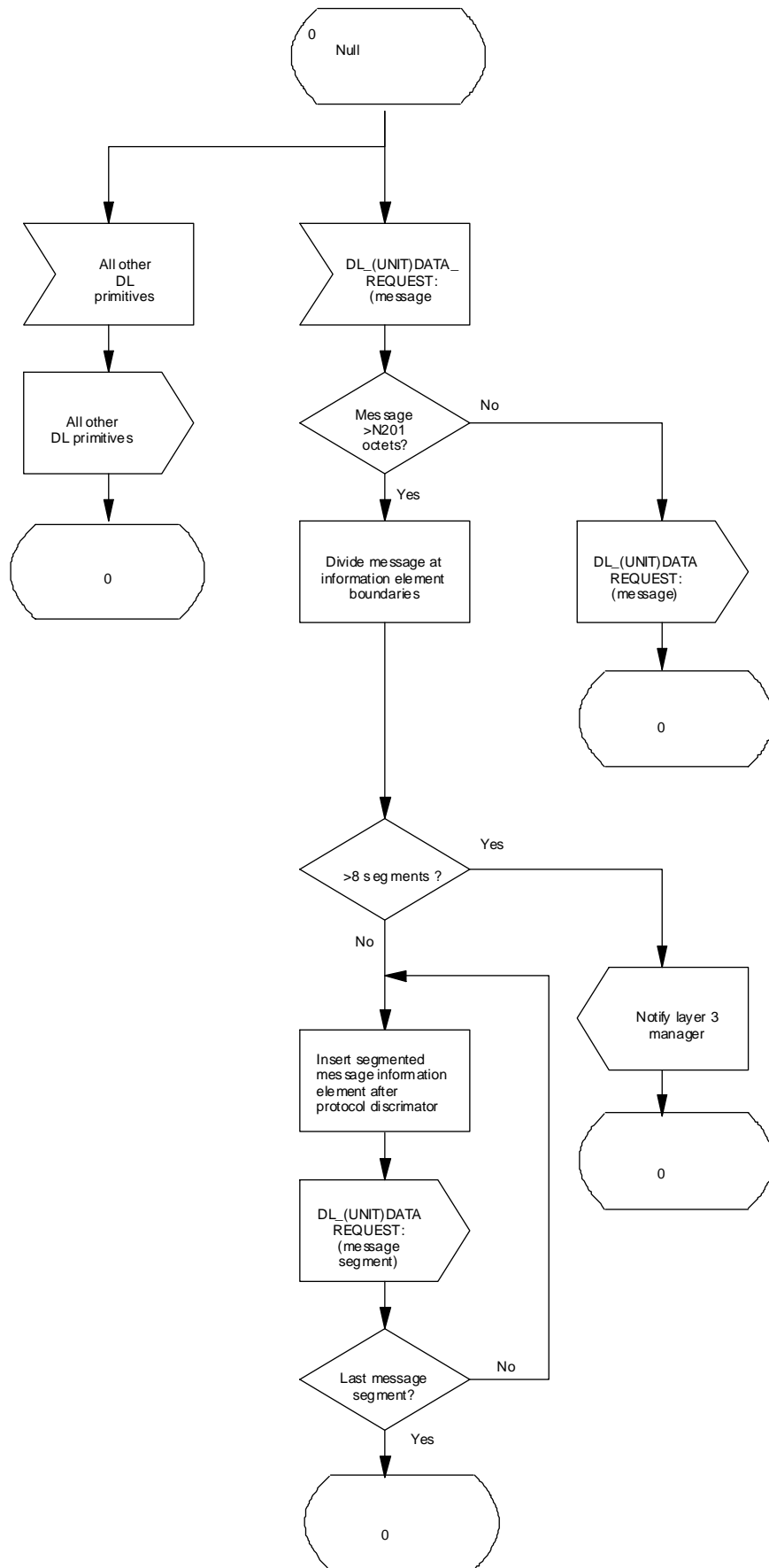

Figure K.4: Message segmenter SDL

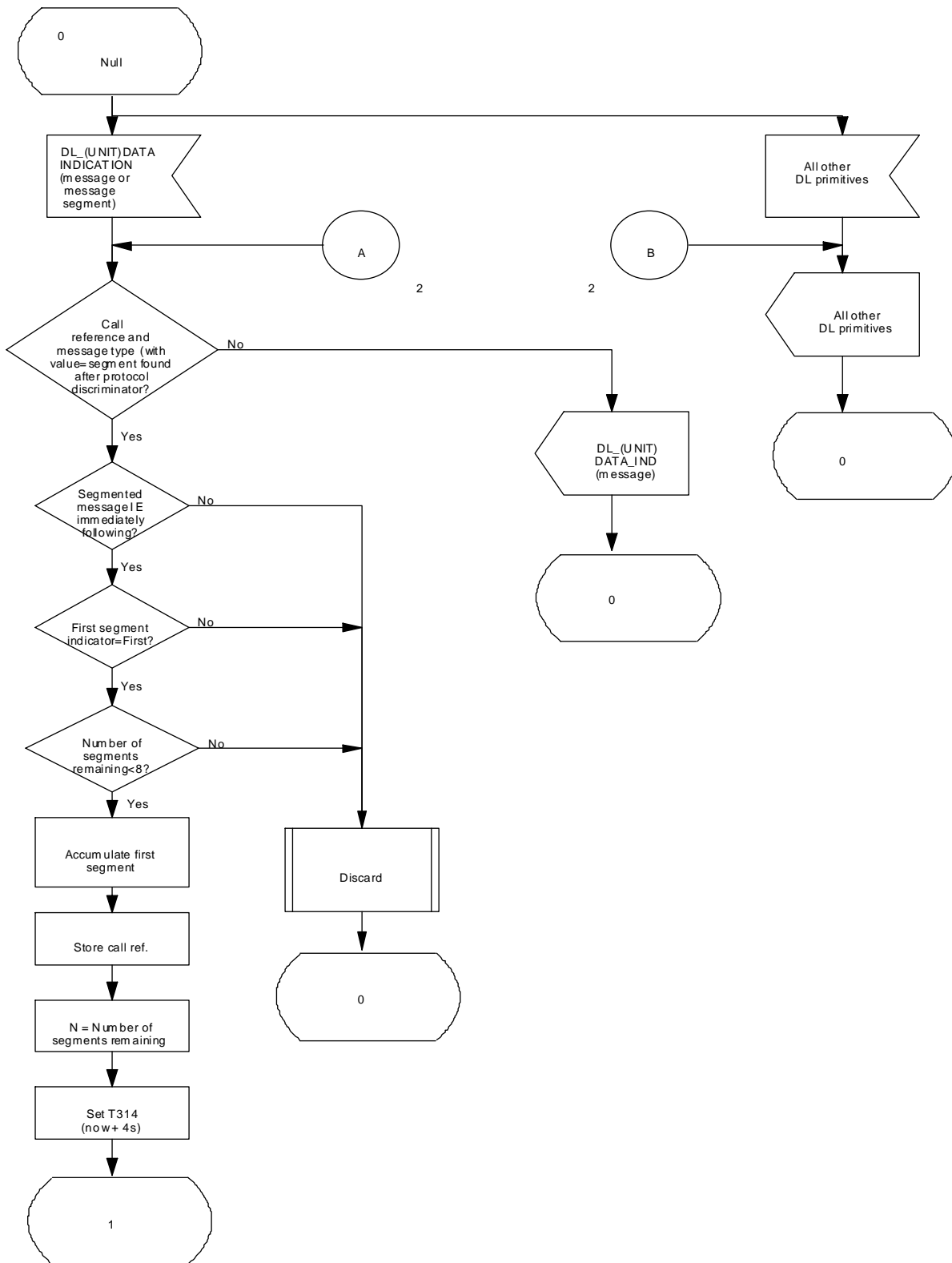

Figure K.5 (sheet 1 of 3): Message segmenter SDL

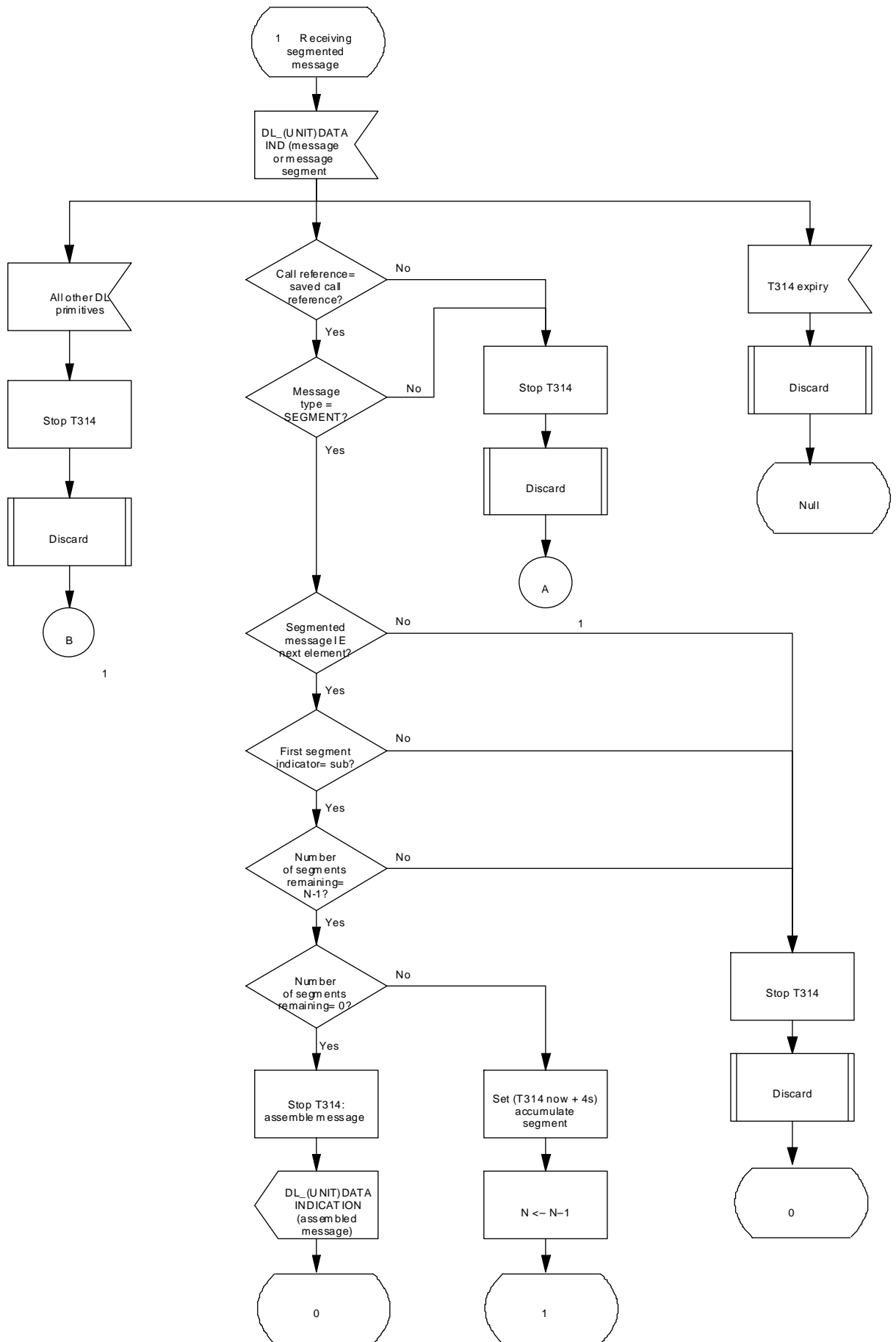

Figure K.5 (sheet 2 of 3): Message reassembler SDL

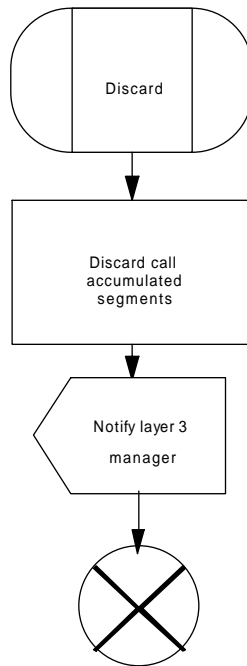

Figure K.5 (sheet 3 of 3): Message reassembler SDL

Annex L (Normative): Low layer information coding principles

L.1 Purpose

This annex describes principles that shall be used when the calling user specifies information during call setup regarding low layer capabilities required in the network and by the destination terminal.

NOTE: In this context and throughout this annex the term "called user" is the end point entity which is explicitly addressed. This may be an addressed interworking unit (IWU) (see CCITT I.500-Series Recommendations and ETS 300 007 case A).

L.2 Principles

L.2.1 Definitions of types of information

There are three different types of information that the calling ISDN user may specify during call setup to identify low layer capabilities needed in the network and by the destination terminal:

- a) type I information is information about the calling terminal which is only used at the destination end to allow a decision regarding terminal compatibility. An example would be modem type. This information is encoded in octets 5 to 7 of the Low layer compatibility information element;
- b) type II information is the selection of bearer services by the network to which the calling user is connected. This type of information is present even if no interworking occurs. An example is unrestricted digital information (UDI). This information is coded in.
 - i) octets 3 and 4 (including octets 4a and 4b if necessary) of the Bearer capability information element when the transfer mode required by the calling user is circuit mode;
 - ii) octets 3, 4, 6 and 7 (including octets 4a and 4b if necessary) of the Bearer capability information element when the transfer mode required by the calling user is packet mode;
- c) type III information is information about the terminal or intended call which is used to decide destination terminal compatibility and possibly to facilitate interworking with other ISDNs or other

dedicated networks. An example is A-law encoding. This information is encoded in octet 5 of the Bearer capability information element.

L.2.2 Examination by the network

Type I information is user-to-user (i.e. not examined by the network) while both types II and III should be available for examination by the destination user and the network. The Low layer compatibility information element is an information element which is not examined by the network while the Bearer capability information element is an information element which is examined by the user and the network.

L.2.3 Location of type I information

Type I information (i.e. terminal information only significant to the called user) shall, when used, be included in the Low layer compatibility information element.

L.2.4 Location of types II and III information

Type II (i.e. bearer selection) information shall be included in the Bearer capability information element. Type III information, when used, is included in the Bearer capability information element. The network may use and modify the information (e.g. to provide interworking). The rationale for the user including some terminal related information in the type III information (interworking related) is shown by the following example.

Normally with UDI, the rate adaption technique chosen is related to the terminal. The specification of a particular rate adaption scheme with a UDI bearer service could allow a compatibility decision by the destination terminal in a purely ISDN situation. However, it could also conceivably be used to allow interworking with a PSTN, assuming that the appropriate functions (i.e. data extraction, modem pool) are available at the interworking unit.

If the rate adaption information is carried in the Low layer compatibility information element, and not in the Bearer capability information element, then interworking by the network providing the bearer capability would not be possible. However, if the rate adaption information is carried in the Bearer capability information element, interworking would be possible.

Hence, there is some terminal related information which may be considered interworking related. The consequence for the calling user of not including such terminal related information in the Bearer capability information element is that the call may not be completed if an interworking situation is encountered.

L.2.5 Relationship between bearer capability and low layer compatibility information elements

There shall be no contradiction of information between the Low layer compatibility and the Bearer capability information elements at the originating side. However, as some bearer capability code points may be modified during the transport of the call, this principle implies that there should be minimal duplication of information between Bearer capability information element and Low layer compatibility information element.

NOTE: If as a result of duplication, a contradiction occurs between the Bearer capability information element and the Low layer compatibility information element at the terminating side, the receiving entity shall ignore the conflicting information in the Low layer compatibility information element.

The following example dealing with the specification of the encoding scheme used by the terminal for the speech or 3.1 kHz audio bearer services, shows the consequences of duplication.

It is expected that some ISDNs will support only A-law and some only μ -law, with conversion provided by the μ -law network (see CCITT Recommendation G.711). If the encoding scheme is specified in both the Bearer capability information element and the Low layer compatibility information element, interworking between two ISDNs might require a change of the user information layer 1 protocol in the Bearer capability information element (e.g. from A-law to μ -law), while the encoding scheme specified in the Low layer compatibility information element would presumably be forwarded to the destination unchanged. Since, to

determine compatibility, the destination terminal examines both the Bearer capability information element and the Low layer compatibility information element, it would receive conflicting information regarding the encoding scheme used.

L.3 Information classification

The following are the examples of classifying low layer information currently identified. This information is provided to facilitate understanding of the characteristics of types II and III information.

L.3.1 Examples for search and 3.1 kHz audio bearer services

- a) Type II information (common to all applications using these bearer services):
- information transfer capability = speech or 3.1 kHz audio;
 - information transfer mode = circuit;
 - information transfer rate = 64 kbit/s;
 - user information layer 1 protocol = A/μ law.
- b) Type III information for interworking with CSPDN (3.1 kHz audio applications are assumed) - figure L-1:
- User information layer 1 protocol = rate adaption + user rate (NOTE);
- NOTE: Only those profiles conforming to CCITT standardized rate adaption are allowed when only the above information is provided.
- c) Type III information for interworking with PSTN:
- i) voice application: figure L-2:
 - user information layer 1 protocol = A/μ law;
 - ii) voice band data applications: figure L-3:
 - user information layer 1 protocol = A/μ law.

L.3.2 Examples for 64 kbit/s UDI circuit mode bearer service

- a) Type II information (common):
- information transfer capability = unrestricted digital information;
 - information transfer mode = circuit;
 - information transfer rate = 64 kbit/s
- b) Type III information for interworking with PSPDN (packet applications). Figure L-4:
- no type III information is required.
- c) Type III information for interworking with PSTN:
- voice applications: Figure L-5
 - no type III information is required;
 - rate-adaption data applications: Figure L-6
 - no type III information is required.

d) Type III information for interworking with PSTN with end-to-end digital connectivity (data applications). Figure L-7:

- user information layer 1 protocol = rate adaption + user rate (NOTE).

NOTE: The profile described in CCITT Recommendation I.463 is allowed.

L.3.3 Examples for ISDN virtual-circuit bearer service

a) Type II information (common):

- information transfer capability = unrestricted digital information;
- information transfer mode = packet; - information transfer rate =;
- user information layer 1 protocol = rate adaption + user rate (NOTE 1);
- user information layer 2 protocol = LAP B (NOTE 2);
- user information layer 3 protocol = X.25 packet layer protocol (NOTE 2).

NOTE 1: This parameter is included only when user packet information flow is rate adapted. Only those profiles conforming to X.31 are allowed when only the above information is provided for layer 1 protocol.

NOTE 2: Only those profiles conforming to X.31 are used. See figures L-8, L-9 and L-10.

b) Type III information for interworking with PSPDN, CSPDN, PSTN: - No type III information is necessary.

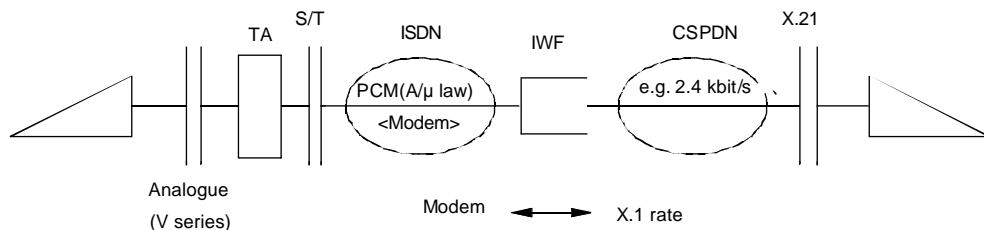

NOTE: Is user rate sufficient to specify the type of modem at IWF?

Figure L.1 BC = 3.1 kHz audio, voice band data → CSPDN

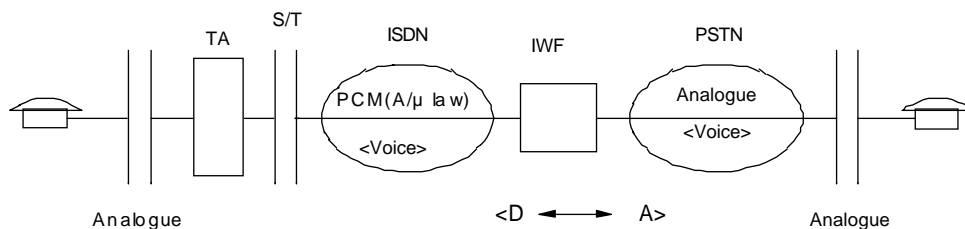

Figure L.2: BC = 3.1 kHz audio. Voice → PSTN

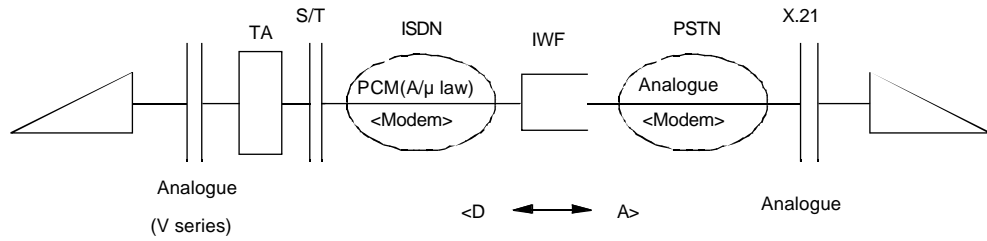

Figure L.3: BC = 3.1 kHz audio, voice band data → PSTN

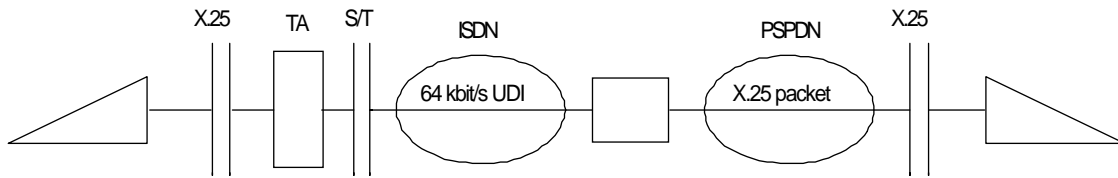

Figure L.4: BC = 64 kbit/s UDI, packet application → PSPDN

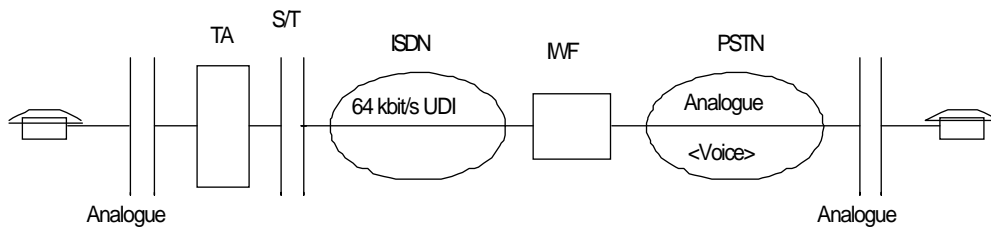

Figure L.5: BC = 64 kbit/s UDI, voice → PSTN

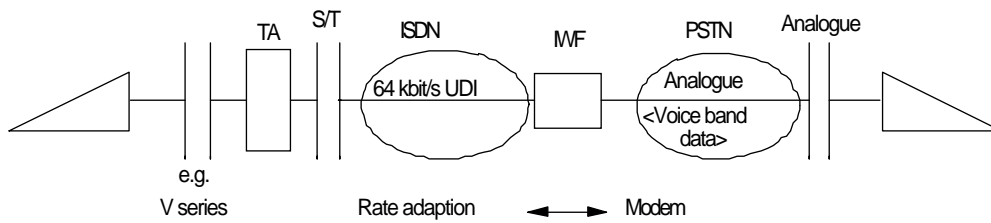

Figure L.6: BC = 64 kbit/s UDI, rate adapted data → PSTN

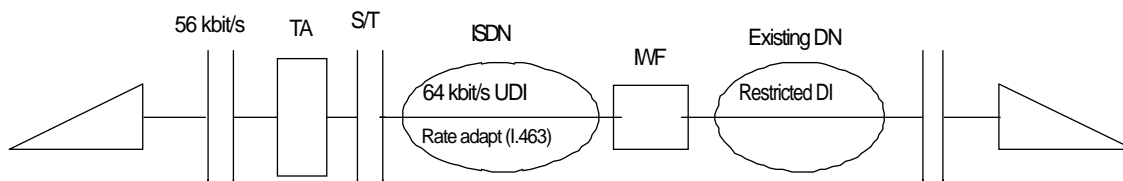

Figure L.7: BC = 64 kbit/s UDI, existing digital network

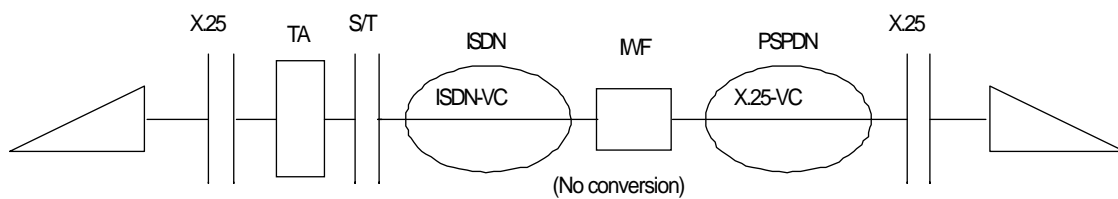

Figure L.8: BC = ISDN virtual circuit (VC) → PSPDN

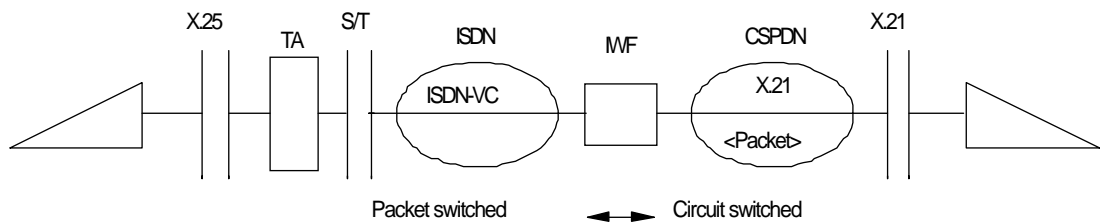

Figure L.9: BC = ISDN virtual circuit (VC) → CSPDN

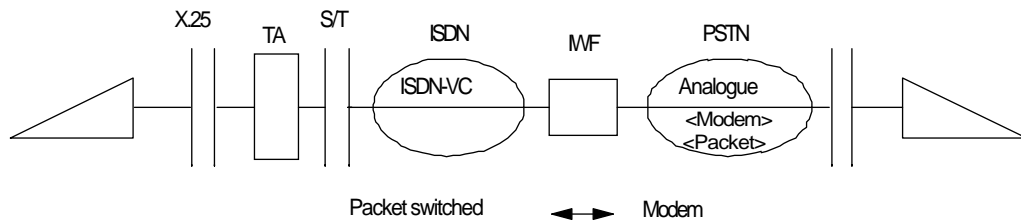

Figure L.10: BC = ISDN virtual circuit (VC) → PSTN

L.4 Scenarios outside the scope of ISDN standardization

L.4.1 Examples for speech and 3.1 kHz audio bearer services

- a) Type II information (common):
 - information transfer capability = speech or 3.1 kHz audio;
 - information transfer mode = circuit;
 - information transfer rate = 64 kbit/s;
 - user information layer 1 protocol: A/μ law.
- b) Type III information for interworking with PSTN - voice band data applications
 - Modem type conversion occurs. Figure L-11:
 - user information layer 1 protocol = rate adaption + user rate + other attributes (if required).

L.4.2 Examples for 64 kbit/s UDI circuit mode bearer services

- a) Type II information (common):
 - information transfer capability = unrestricted digital information;
 - information transfer mode = circuit;
 - information transfer rate = 64 kbit/s;
- b) Type III information for interworking with PSTN - voice band data applications. Figure L-12:
 - no type III information is required.

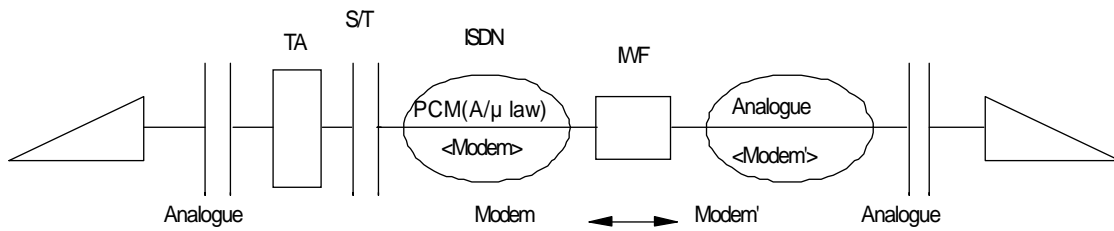

Figure L.11: BC = 3.1 kHz audio, voice band → PSTN

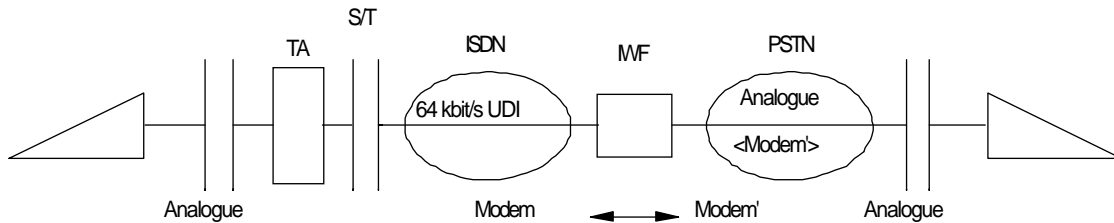

Figure L.12: BC = 64 kbit/s UDI, voice band data → PSTN

Annex M (Normative): Low layer compatibility negotiation

This annex describes an additional low layer compatibility checking procedure that may be applied by the user. However, this is a network option and may not be supported by all networks.

M.1 General

The purpose of the Low layer compatibility information element is to provide a means which should be used for compatibility checking by an addressed entity (e.g. a remote user or an interworking unit or a high layer function network node addressed by the calling user). The Low layer compatibility information element is transferred transparently by an ISDN between the call originating entity (e.g. the calling user) and the addressed entity.

The user information protocol fields of the Low layer compatibility information element indicate the low layer attributes at the call originating entity and the addressed entity. This information is not interpreted by the ISDN and therefore the bearer capability provided by the ISDN is not affected by this information. The call originating entity and the addressed entity may modify the low layer attributes by the negotiation described below if that can be supported by the bearer capability actually provided by the ISDN.

The Low layer compatibility information element is coded according to section 4.5.18.

M.2 Low layer capability notification to the called user

When the calling user wishes to notify the called user of any information transfer attribute (contained in octets 3 to 4b) different from the ones contained in the Bearer capability information element or of any low layer protocol to be used during the call and not already identified in the Bearer capability information element, then the calling user shall include a Low layer compatibility information element in the SETUP message; this element is conveyed by the network and delivered to the called user. However, if the network is unable to convey this information element, it shall act as described in section 5.8.7.1 (unrecognized information element).

M.3 Low layer capability negotiation between users

If the negotiation indicator (see section 4.5.18) of the Low layer compatibility information element included in the SETUP message is set to Out-band Low layer compatibility negotiation allowed, then one or more of the low layer protocol attribute(s) may be negotiated. In this case, the called user responding positively to the call may include a Low layer compatibility information element in the CONNECT message. This element will be conveyed transparently by the network and delivered to the calling user in the CONNECT message.

NOTE: Only the low layer protocol attributes may be negotiated and therefore the information transfer attributes (octets 3 to 4), if returned by the called user in the CONNECT message, will be identical to the ones received in the Low layer information element contained in the SETUP message.

If, for any reason, the network is unable to convey this information element, it shall act as described in section 5.8.7.1 (unrecognized information element). Users are advised not to include in the Low layer compatibility information element sent from the called user to the calling user attributes which would have the same value as the ones contained in the Low layer compatibility information element received from the calling party.

M.4 Low layer compatibility negotiation options

The Low layer compatibility information element contains a negotiation indicator which may have one of the following values:

- a) Low layer compatibility negotiation not allowed (default): then the called user shall not invoke negotiation at all.
- b) Out-band Low layer compatibility negotiation allowed: the called user may then invoke LLC negotiation, as needed, according to section 3 above.
- c) In-band negotiation allowed: the called user may then invoke Low layer compatibility negotiation using the supported in-band negotiation, according to service or application requirements.
- d) Either in-band or out-band negotiation allowed: the called user may invoke one or the other low layer compatibility negotiation procedures according to its requirements. If the call is end-to-end ISDN, and the out-band low layer compatibility negotiation is supported by both parties, then this method of negotiation is preferred.

Annex N (Normative): Procedures for establishment of bearer connection prior to call acceptance

N.1 General

For some applications, it is desirable to allow the completion of the transmission path associated with a bearer service prior to receiving call acceptance. In particular, the completion of the backward direction of the transmission path prior to receipt of a CONNECT message from the called user may be desirable to:

- a) allow the called user to provide internally-generated tones and announcement that are sent in-band to the calling user prior to answer by the called user; or
- b) avoid speech clipping on connections involving an NT2 where delays may occur in relaying the answer indication within the called user equipment.

The procedures described in this annex are only applicable to the speech and 3.1 kHz audio bearer services.

NOTE: The definition of necessary mechanisms (if any) with Signalling System N^o.7 to avoid any potential undesirable charging implications remain for further study.

N.2 Procedures

As a network option, completion of the transmission path prior to receipt of a call acceptance indication may be provided in one of three ways:

- a) On completion of successful channel negotiation at the destination interface; or,
- b) On receipt of a message containing an indication that in-band information is being provided; or,

c) Not at all; i.e. this option is not supported by the network.

When criterion (a) is used to determine that the transmission path should be established, the network shall connect, as a minimum, the backward side of the transmission path upon receipt of either a CALL PROCEEDING message or an ALERTING message containing an acceptable B-channel indication.

When criterion (b) is used to establish the transmission path, the network shall connect, as a minimum, the backward side of the transmission path upon receipt of either an ALERTING message or a PROCESS message containing progress indicator #8 "in-band information or appropriate pattern now available" or progress indicator #1 "call is not end-to-end ISDN; further call progress information may be available in-band", respectively.

The network providing the early completion of the transmission path in the backward direction may choose to support only one of the methods (a) or (b) above. The network may choose to further restrict which message(s) will result in establishment of the transmission path. These restrictions may be imposed on a per-interface basis to provide an administrative means for limiting potential misuse of the early connection capabilities.

ETSI Requirement: In ISDNs conforming to this ETS, the procedures described in this annex are optional. ISDNs which choose to implement these procedures must ensure that they are not used on incoming international calls.

Annex O (Informative): Optional procedures for bearer service change

ETSI Requirement: This annex is not applicable in ISDNs conforming to this ETS.

Annex P (Informative): Formal Definitions for the Facility information element

This informative annex provides information to be provided by the generic supplementary services ETS as yet unpublished and currently known as ETSI T/S 46-32B. When that document is published, it shall supersede this annex.

Figures P.1 and P.2 provide abstract syntax notation for the components of the Facility information element (see §4.6.2).

```

OPERATION MACRO ::=
BEGIN
TYPE NOTATION ::= Argument Result Errors LinkedOperations
VALUE NOTATION ::= value (VALUE CHOICE {
localValue INTEGER,
-- used for operations defined in
-- this series of recommendations
globalValue OBJECT IDENTIFIER
-- used for national-specific or
-- network-specific operations })
Argument ::= "ARGUMENT" NamedType | empty
Result ::= "RESULT" ResultType | empty
Errors ::= "ERRORS" "{" ErrorNames "}" | empty

LinkedOperations ::= "LINKED" "{" LinkedOperationNames "}" | empty
NamedType ::= identifier type | type
ResultType ::= NamedType | empty
ErrorNames ::= ErrorList | empty

ErrorList ::= Error | ErrorList "," Error
Error ::= value (ERROR) -- shall reference an error value
| type -- shall reference an error type if no error value specified
LinkedOperationNames ::= OperationList | empty
OperationList ::= Operation | OperationList "," Operation
Operation ::= value (OPERATION) -- shall reference an operation value
| type -- shall reference an operation type if no error value is
specified

END -- of OPERATION macro

ERROR MACRO ::=
BEGIN
TYPE NOTATION ::= Parameter
VALUE NOTATION ::= value (VALUE CHOICE {
localValue INTEGER,
-- used for operations defined in
-- this series of recommendations
globalValue OBJECT IDENTIFIER
-- used for national-specific or
-- network-specific operations })
Parameter ::= "PARAMETER" NamedType | empty
NamedType ::= identifier type | type
END -- of ERROR macro

```

Figure P.1: Formal definition of OPERATION and ERROR macros

-- Component definitions:

-- Types and values of operations and errors are defined in the Q.93x series of Recommendations -- or elsewhere using this form of Remote Operations notation. Operation values and error values -- are either of integer type or of object identifier type. If integer types are used, they shall be -- distinct within that abstract syntax adopted in the Q.93x Recommendations.

```

Component ::= CHOICE {invokeComp [1] IMPLICIT InvokeComponent,
                      retResultComp [2] IMPLICIT ReturnResultComponent,
                      retErrorComp [3] IMPLICIT ReturnErrorComponent,
                      rejectComp [4] IMPLICIT RejectComponent }

InvokeComponent ::= SEQUENCE {invokeldIdentifier InvokeldIdentifierType,
                             linkedIdentifier [0] IMPLICIT InvokeldIdentifierType
                             OPTIONAL,
                             operationValue OPERATION,
                             argument ANY DEFINED BY operationValue OPTIONAL}
-- ANY is filled by the single ASN.1 data type following the keyword
-- ARGUMENT in the type definition of a particular operation

ReturnResultComponent ::= SEQUENCE {invokeld InvokeldIdentifierType,
                                    SEQUENCE {operationValue OPERATION,
                                                result ANY DEFINED BY operationValue
                                                } OPTIONAL}
-- ANY is filled by the single ASN.1 data type following the keyword
-- RESULT in the type definition of a particular operation

ReturnErrorComponent ::= SEQUENCE {invokeld InvokeldIdentifierType,
                                   errorValue ERROR,
                                   parameter ANY DEFINED BY errorValue OPTIONAL}
-- ANY is filled by the single ASN.1 data type following the keyword
-- PARAMETER in the type definition of a particular error

RejectComponent ::= SEQUENCE {invokeld CHOICE {
                               InvokeldIdentifierType,
                               NULL }
                          problem CHOICE {
                          [0] IMPLICIT GeneralProblem,
                          [1] IMPLICIT InvokeProblem,
                          [2] IMPLICIT ReturnResultProblem,
                          [3] IMPLICIT ReturnErrorProblem } }

InvokeldIdentifierType ::= INTEGER

GeneralProblem ::= INTEGER { -- detected by Q.932 protocol entity
                             unrecognizedComponent (0),
                             mistypedComponent (1),
                             badlyStructuredComponent (2) }

InvokeProblem ::= INTEGER { -- detected by particular supplementary service entity
                             duplicateInvocation (0),
                             unrecognisedOperation (1),
                             mistypedArgument (2),
                             resourceLimitation (3),
                             initiatorReleasing (4),
                             unrecognisedLinkedId (5),
                             linkedResponseUnexpected (6),
                             unexpectedChildOperation (7) }

ReturnResultProblem ::= INTEGER { -- detected by particular supplementary service entity
                             unrecognisedInvocation (0),
                             resultResponseUnexpected (1),
                             mistypedResult (2) }

ReturnErrorProblem ::= INTEGER { -- detected by particular supplementary service entity
                             unrecognisedInvocation (0),
                             errorResponseUnexpected (1),
                             unrecognisedError (2),

```

```
unexpectedError (3),  
mistypedParameter (4) }
```

Figure P.2: Formal definition of Facility information element component

Appendix I (Informative): (to ETS 300 102-1): Usage of cause values

Table I-2 indicates the usage of cause values within ETS 300 102-1. Other usage may be provided within other standards or Recommendations, e.g. CCITT Q.700 series and Q.699. Other causes may also be used by Q.931 entities where this is not precluded by the procedures defined elsewhere in ETS 300 102-1.

Table I-1 defines the key for the location of generation in table I-2. For more precise usage of the location codes in the Cause information element, see Annex J.

Table I-1: Key for the location of the generation in table I-2

LU:	Local user
LN:	Local network
TN:	Transit network
RN:	Remote network
RU:	Remote user
LPE:	Local peer entity (for symmetrical operation, see Annex D)

The following abbreviations to message types are used in table II-2.

CON CON	CONGESTION CONTROL
DISC	DISCONNECT
REL	RELEASE
REL COM	RELEASE COMPLETE
RES REJ	RESUME REJECT
STAT	STATUS
SUSP REJ	SUSPEND REJECT

Table I-2 (1 of 8): Usage of cause values

Cause No.	Class	Value	Cause name	Diagnostics	Section cross-reference	Typical location of generation	Typical carrying message as identified by receiving side	
							At remote interface	At local interface
1	000	0001	Unassigned (unallocated number)	Condition	5.1.4	LN		REL COM DISC
					5.2.4	RU	REL COM DISC	
2	000	0010	No route to specified transit network	Transit network identity/network specific facilities information elements	C.2	TN		DISC
					E.3	LN		REL COM
3	000	0011	No route to destination	Condition	5.1.4	LN		DISC REL COM
					5.2.4	RU	REL COM DISC	DISC
6	000	0110	Channel unacceptable		5.2.3.1c 5.3.2d T/S46-50	LN		REL
7	000	0111	Call awarded and being delivered in an established channel		T/S46-50	LN		REL
16	001	0000	Normal call clearing			RU	DISC	DISC
17	001	0001	User busy		5.2.5.1 5.2.5.4b	RU	REL COM	DISC
					No procedure	RN		DISC

Table I-2 (2 of 8): Usage of cause values

Cause No.	Class	Value	Cause name	Diagnostics	Section cross-reference	Typical location of generation	Typical carrying message as identified by receiving side	
							At remote interface	At local interface
18	001	0010	No user responding		5.2.5.3	RN		DISC
19	001	0011	User alerting, no answer		5.2.5.3	RN		DISC
21	001	0101	Call rejected	Condition: user supplied diagnostic	5.2.5.1 5.2.5.4b	RU	REL COM	DISC
22	001	0110	Number changed	New destination number	5.1.4	LN		DISC REL COM
					5.2.4	RU	REL COM DISC	DISC
26	001	1010	Non-selected user clearing		5.3.2b T/S 46-50	LN		REL
27	001	1011	Destination out of order		5.8.9	RN		DISC
28	001	1100	Invalid number format (incompatible number)			LN		REL COM DISC
					5.2.4	RU	DISC REL COM	DISC
					5.1.5.2	LN		DISC
					5.2.4	RN		DISC
					5.1.4	LN		DISC REL COM

Table I-2 (3 of 8): Usage of cause values

Cause No.	Class	Value	Cause name	Diagnostics	Section cross-reference	Typical location of generation	Typical carrying message as identified by receiving side	
							At remote interface	At local interface
29	001	1101	Facility rejected	Facility identification	No procedure in T/S 46-30	LN		REL COM DISC
						RN		DISC
						RU	REL COM DISC	
30	001	1110	Response to STATUS ENQUIRY		5.8.10	LU, LN		STAT
31	001	1111	Normal unspecified		5.8.4	RN		REL COM DISC
34	010	0010	No circuit/channel available		5.1.1 5.1.2	LN		REL COM
					5.2.3.1b 5.2.3.1e 5.2.3.2 T/S 46-50	RU	REL COM	DISC
					C.2	LN	REL COM DISC	REL COM DISC
					C.2	TN		DISC
					D.1.1e D.3.b	LPE		REL COM
38	010	0110	Network out of order		No procedure			
41	010	1001	Temporary failure		5.8.8	LU, LN		DISC
					5.8.10	LU, RU, RN	DISC	DISC

Table I-2 (4 of 8): Usage of cause values

Cause No.	Class	Value	Cause name	Diagnostics	Section cross-reference	Typical location of generation	Typical carrying message as identified by receiving side	
							At remote interface	At local interface
42	010	1010	Switching equipment congestion		No procedure			REL REL COM
43	010	1011	Access information discarded	Discarded information element identifier(s)	7.1.5.7	RU, LN		CON CON
					7.1.6.1	LN		STAT
					5.8.7.2	LN, LU		STAT
44	010	1100	Requested circuit/channel not available		5.1.2	LN		REL COM
					5.2.3.1e 5.2.3.2 T/S 46-50	RU	REL COM	DISC
					D.1.1e			REL COM
47	010	1111	Resource unavailable, unspecified		No procedure			
49	011	0001	Quality of Service unavailable	Condition	T/S 46-50			REL REL COM
50	011	0010	Requested facility not subscribed	Facility identification	7.1.3.6	RU	DISC REL COM	DISC
					7.1.4.3 7.1.5.3	RN		DISC
					7.1.7.4	LN		REL COM
57	011	1001	Bearer capability not authorized	Attributes of bearer capability	5.1.5.2	LN		DISC REL COM
					7.2.2	LN		REL REL COM

Table I-2 (5 of 8): Usage of cause values

Cause No.	Class	Value	Cause name	Diagnostics	Section cross-reference	Typical location of generation	Typical carrying message as identified by receiving side	
							At remote interface	At local interface
58	011	1010	Bearer capability not authorized	Attributes of bearer capability	5.1.5.2	LN		DISC REL COM
					7.2.2	LN		REL REL COM
63	011	1111	Service or option not available, unspecified		5.1.5.2	LN		DISC REL COM
65	100	0001	Bearer capability not implemented	Attributes of bearer capability	5.1.5.2	LN		DISC REL COM
					T/S 46-50	LN		REL COM
66	100	0010	Channel type not implemented	Channel type	No procedure			
69	100	0101	Requested facility not implemented	Facility identification	7.1.3.6	RU	DISC REL COM	DISC
					7.1.4.3 7.1.5.3	RN		REL DISC
					7.1.7.4	LN		REL REL COM
70	100	0110	Only restricted digital information bearer capability is available		No procedure (Network dependent option)			
79	100	1111	Service or option not implemented, unspecified					

Table I-2 (6 of 8): Usage of cause values

Cause No.	Class	Value	Cause name	Diagnostics	Section cross-reference	Typical location of generation	Typical carrying message as identified by receiving side	
							At remote interface	At local interface
81	101	0001	Invalid call reference value		5.8.3.2a	LU, LN		REL REL COM
					5.8.3.2b	LU, LN		REL COM
					5.8.3.2f	LU, LN		STAT
82	101	0010	Identified channel does not exist	Channel identity	No procedure			REL COM
83	101	0011	A suspended call exists, but this call identity does not		5.6.5	LN		RES REJ
84	101	0100	Call identity in use		5.6.3	LN		SUSP REJ
85	101	0101	No call suspended		5.6.5	LN		RES REJ
86	101	0110	Call having the requested call identity has been cleared		5.6.5	LN		RES REJ
88	101	0111	Incompatible destination	Incompatible parameter	5.2.2 5.2.5.1 5.2.5.3a B.3.2 B.3.3	RU	REL COM	DISC
91	101	1011	Invalid transit network selection		C.2	TN		DISC
						LN		DISC REL REL COM

Table I-2 (7 of 8): Usage of cause values

Cause No.	Class	Value	Cause name	Diagnostics	Section cross-reference	Typical location of generation	Typical carrying message as identified by receiving side	
							At remote interface	At local interface
95	101	1111	Invalid message, unspecified	Message type	5.8	LN		REL COM STAT
96	110	0000	Mandatory information element is missing	Information element identifier(s)	5.8.6.1	LN, LU		REL REL COM STAT
					5.8.11	LN, LU		STAT
97	110	0001	Message type non-existent or not implemented	Message type	5.8.4 5.8.10 5.8.11	LU, LN		STAT
98	110	0010	Message not compatible with call state or message type Non-existent of not implemented	Message type	5.8.4	LU, LN		STAT
99	110	0011	Information element non-existent or not implemented	Information element identifier(s)	5.8.7.1 5.8.11	LU, LN		STAT
					5.8.7.1	LN		REL REL COM
100	110	0100	Invalid information element contents	Information element identifier(s)	5.8.6.2	LU, LN		STAT REL REL COM
					5.8.7.2 5.8.11	LU, LN		STAT
101	110	0101	Message not compatible with call state	Message type	5.8.4	LN, LU		STAT
					5.8.11	LN, LU		DISC REL REL COM

Table I-2 (8 of 8): Usage of cause values

Cause No.	Class	Value	Cause name	Diagnostics	Section cross-reference	Typical location of generation	Typical carrying message as identified by receiving side	
							At remote interface	At local interface
102	110	0110	Recovery on time expiry	Timer number	5.2.4 5.2.5.3 5.6.5	LN		DISC
					5.3.3 5.3.4	LN		REL
					5.8.2f 5.3.3 5.6.5	LU		REL
111	110	1111	Protocol error, unspecified		5.8.4	RN		DISC
127	111	1111	Interworking, unspecified		No explicit procedure			

**Appendix II (Informative): (to ETS 300 102-1): Example message flow diagrams
and example conditions for cause mapping**

The content of this Appendix is identical to that of ETS 300 007, Appendix III and therefore is not reproduced in this ETS.

Appendix III (Informative) (to ETS 300 102-1): Summary of assigned information element identifier and message type code points for the T/S 46-XX series of ETSs

Table III-1 (sheet 1 of 2): Codeset O Information Element Code Points

8 7 6 5 4 3 2 1	ETS Reference
1 : : : - - - -	Single octet information elements:
0 0 0 - - - -	reserved
0 0 1 - - - -	shift ETS 300 102-1
0 1 0 0 0 0 0	more data ETS 300 102-1
0 1 0 0 0 0 1	sending complete ETS 300 102-1
0 1 1 - - - -	congestion level ETS 300 102-1
0 : : : : : :	Variable length information elements
0 0 0 0 0 0 0	segmented message ETS 300 102-1
0 0 0 0 1 0 0	bearer capability ETS 300 102-1
0 0 0 1 0 0 0	cause ETS 300 102-1
0 0 1 0 0 0 0	call identity ETS 300 102-1
0 0 1 0 1 0 0	call state ETS 300 102-1
0 0 1 1 0 0 0	channel identification ETS 300 102-1
0 0 1 1 1 0 0	facility ETS 300 102-1, ETS T/S 46-32
0 0 1 1 1 1 0	progress indicator ETS 300 102-1
0 1 0 0 0 0 0	network specific facilities ETS 300 102-1
0 1 0 0 1 1 1	notification indicator ETS 300 102-1
0 1 0 1 0 0 0	display ETS 300 102-1
0 1 0 1 0 0 1	date/time ETS 300 102-1
0 1 0 1 1 0 0	keypad facility ETS 300 102-1
0 1 1 0 1 0 0	signal ETSI T/S 46-32
1 0 0 0 0 0 0	information rate ETS 300 007
1 0 0 0 0 1 0	end-to-end transit delay ETS 300 007
1 0 0 0 0 1 1	transit delay selection ETS 300 007
1 0 0 0 1 0 0	and indication ETS 300 007
1 0 0 0 1 0 1	packet layer binary parameters ETS 300 007
1 0 0 0 1 1 0	packet layer window size ETS 300 007
1 0 0 0 1 1 1	packet size ETS 300 007
1 0 0 0 1 1 1	minimum throughput class ETS 300 007
1 1 0 1 1 0 0	calling party number ETS 300 102-1
1 1 0 1 1 0 1	calling party subaddress ETS 300 102-1
1 1 1 0 0 0 0	called party number ETS 300 102-1
1 1 1 0 0 0 1	called party subaddress ETS 300 102-1
1 1 1 0 1 0 0	redirecting number ETSI T/S 46-33R, ETS 300 007
1 1 1 1 0 0 0	transit network selection ETS 300 102-1
1 1 1 1 0 0 0	restart indicator ETS 300 102-1
1 1 1 1 1 0 0	low layer compatibility ETS 300 102-1
1 1 1 1 1 0 1	high layer compatibility ETS 300 102-1
1 1 1 1 1 1 0	user-user ETS 300 102-1
1 1 1 1 1 1 1	escape for extension ETS 300 102-1

All other values are reserved (see NOTE).

NOTE: All reserved values with bits 5-8 coded "0000" are for future information elements for which comprehension by the user is required, see §5.8.7.1.

Table III-1 (sheet 2 of 2): Codeset 5 information element code-points

8 7 6 5 4 3 2 1		Section Reference
1 : : : : : :	Single octet information elements:	
0 0 0 - - - -	reserved	ETS 300 102-1
0 0 1 - - - -	shift	§4.5.3/4.5.4
0 : : : : : :	Variable length information elements:	
0 0 0 0 0 0 0	Interpreter (ETSI requirement 1)	
0 0 0 1 1 0 0	Reserved for reasons of backward compatibility	
0 0 0 1 1 0 1	Reserved for reasons of backward compatibility	
0 0 1 1 0 1 0	Reserved for reasons of backward compatibility	
0 1 1 0 0 0 0	Reserved for private network application	
0 1 1 0 0 0 1	Reserved for private network application	
0 1 1 0 0 1 0	Reserved for private network application	
0 1 1 0 0 1 1	Reserved for private network application	
0 1 1 0 1 0 0	Reserved for private network application	
0 1 1 0 1 0 1	Reserved for private network application	
0 1 1 0 1 1 0	Reserved for private network application	
0 1 1 0 1 1 1	Reserved for private network application	
1 1 0 0 1 0 0	Call category (ETSI requirement 1)	
1 1 1 0 1 1 1	Originally called party number	ETSI T/S 46-33R
1 1 1 1 0 0 0	Redirection subaddress	ETSI T/S 46-33R
1 1 1 1 0 0 1	Redirecting subaddress	ETSI T/S 46-33R
1 1 1 1 0 1 0	Originally called subaddress	ETSI T/S 46-33R
1 1 1 1 1 0 0	Connected number	ETSI T/S 46-33R
1 1 1 1 1 0 1	Connected subaddress	ETSI T/S 46-33R
1 1 1 1 1 1 1	Escape for extension (ETSI requirement 2)	
ETSI requirement 1:	The Interpreter and Call category information elements are not supported by networks conforming to this ETS. They are provided as a means to facilitate the use of this ETS for private network applications, see e.g. ETSI T/S 49-30.	
ETSI requirement 2:	This escape mechanism is limited to codesets 5, 6 and 7 (see §4.5.2). When the escape for extension is used, the information element identifier is contained in octet group 3 and the content of the information element follows in the subsequent octets as shown in figure 4.8.	

Table III-2: Message Type Code Points

8 7 6 5 4 3 2 1		ETS Reference
0 0 0 0 0 0 0 0	Escape to nationally specific message type	ETS 300 102-1
0 0 0 - - - - -	Call establishment messages:	
0 0 0 0 1	Alerting	ETS 300 102-1
0 0 0 1 0	Call Proceeding	ETS 300 102-1
0 0 0 1 1	Progress	ETS 300 102-1
0 0 1 0 1	Setup	ETS 300 102-1
0 0 1 1 1	Connect	ETS 300 102-1
0 1 1 0 1	Setup Acknowledge	ETS 300 102-1
0 1 1 1 1	Connect Acknowledge	ETS 300 102-1
0 0 1 - - - - -	Call information phase messages:	
0 0 0 0 0	User information	ETS 300 102-1
0 0 0 0 1	Suspend Reject	ETS 300 102-1
0 0 0 1 0	Resume Reject	ETS 300 102-1
0 0 1 0 0	Hold	ETSI T/S 46-32
0 0 1 0 1	Suspend	ETS 300 102-1
0 0 1 1 0	Resume	ETS 300 102-1
0 1 0 0 0	Hold Acknowledge	ETSI T/S 46-32
0 1 1 0 1	Suspend Acknowledge	ETS 300 102-1
0 1 1 1 0	Resume Acknowledge	ETS 300 102-1
1 0 0 0 0	Hold Reject	ETSI T/S 46-32
1 0 0 0 1	Retrieve	ETSI T/S 46-32
1 0 0 1 1	Retrieve Acknowledge	ETSI T/S 46-32
1 0 1 1 1	Retrieve Reject	ETSI T/S 46-32
0 1 0 - - - - -	Call clearing messages:	
0 0 1 0 1	Disconnect	ETS 300 102-1
0 0 1 1 0	Restart	ETS 300 102-1
0 1 1 0 1	Release	ETS 300 102-1
0 1 1 1 0	Restart Acknowledge	ETS 300 102-1
1 1 0 1 0	Release Complete	ETS 300 102-1
0 1 1 - - - - -	Miscellaneous messages:	
0 0 0 0 0	Segment	ETS 300 102-1
0 0 0 1 0	Facility	ETS 300 102-1
0 0 1 0 0	Register	ETSI T/S 46-32
0 1 1 1 0	Notify	ETS 300 102-1
1 0 1 0 1	Status Enquiry	ETS 300 102-1
1 1 0 0 1	Congestion Control	ETS 300 102-1
1 1 0 1 1	Information	ETS 300 102-1
1 1 1 0 1	Status	ETS 300 102-1

Table III-3: Operation Values Assigned within the Invoke Component of the facility Information Elements

8 7 6 5 4 3 2 1	
0 0 0 0 0 0 0 1	User-user service

History

Document history	
December 1990	First Edition
February 1996	Converted into Adobe Acrobat Portable Document Format (PDF)