

UNCLASSIFIED

**IDENTIFICATION OF VOLATILE
AND NON-VOLATILE STORAGE
AND
SANITIZATION OF SYSTEM COMPONENTS**

**JUNIPER NETWORKS
EX2200 and EX2200-C Switches**

**REVISION 1.0
September 10, 2012**

UNCLASSIFIED

TABLE OF CONTENTS

1	Introduction	1
1.1	Purpose.....	1
1.2	Scope	1
2	Equipment Overview	1
2.1	Identification of Chassis	1
2.2	Description of Field Replaceable Units (FRU)	3
3	Power Down and Removal of Non-Volatile Storage.....	3
3.1	System Power Down	3
3.2	Disassembly of the EX2200 Chassis and Identification of NV storage.....	3
3.3	Disassembly of the EX2200-C Chassis and Identification of NV storage.....	6
3.4	Removal of the FLASH Chip from the System Board.....	8

TABLE OF FIGURES

Figure 2-1:	EX2200	2
Figure 2-2:	EX2200-C.....	2
Figure 3-1:	EX2200 Top side screws.....	3
Figure 3-2:	EX2200 Left side screws.....	4
Figure 3-3:	EX2200 Right side screws	4
Figure 3-4:	EX2200 Rear screws.....	5
Figure 3-5:	EX2200 Open Chassis.....	5
Figure 3-6:	EX2200 Locate NV Storage (Flash).....	6
Figure 3-7:	EX2200-C Top side screws	6
Figure 3-8:	EX2200-C Open Chassis	7
Figure 3-9:	EX2200-C Locate NV Storage (Flash)	7

1 INTRODUCTION

1.1 Purpose

The purpose of this document is to provide direction to identify and remove all non-volatile (NV) storage from the Juniper Networks EX2200 and EX2200-C switching platforms.

1.2 Scope

This document only addresses the EX2200 and EX2200-C switching platforms. While other platforms offered by Juniper Networks may contain similar hardware components, this document only applies to these devices. Furthermore, this document only provides direction for the identification and removal of NV storage components. It does not address destruction procedures for those components. As all of the NV storage components used in the EX2200 and EX2200-C are commercial off-the-shelf (COTS) components, directions for destruction of those components are left to the governing Department, Agency, or Office.

2 EQUIPMENT OVERVIEW

2.1 Identification of Chassis

EX-series switches provide scalable connectivity for the enterprise market, including branch offices, campus locations, data centers and retail access deployments. The switches run under the JUNOS software, which provides Layer 2 and Layer 3 switching, routing, and security services. The same JUNOS code base that runs on EX-series switches also runs on all Juniper Networks J-series, M-series, MX-series, and T-series routing platforms.

EX2200 switches provide connectivity for medium and high-density environments and scalability for growing networks. EX2200-C switches extend the reach of EX2200 switches towards lower entry price-point, low density and lower acoustics. The EX2200 switches can be deployed wherever you need a high density of Gigabit Ethernet ports (24 to 48 ports) or redundancy. The EX2200-C switches can be deployed in a micro-branch access outside the wiring closet where low density of Gigabit Ethernet ports (12 ports) is needed.

EX2200 switches are available in models with 24 or 48 ports equipped for Power over Ethernet (PoE). EX2200-C switches are available in model with 12 ports equipped for PoE. All models provide ports that have 10/100/1000Base-T Gigabit Ethernet connectors.

The EX2200 and EX2200-C switches also include the following components:

- Factory-installed power supplies. An optional additional connection to an external power source is also available for the EX2200.
- Factory-installed three DC brushless fans (EX2200). EX2200-C are fanless switches.
- JUNOS software with its modular design that enables failed system processes to gracefully restart.

EX2200 switches provide four fixed ports for uplink connectivity which support 100Mbps and 1Gbps small form-factor pluggable (SFP) transceivers. EX2200-C switches provide 2 dual-purpose fixed ports for uplink connectivity which support 100Mbps and 1Gbps small form-factor pluggable (SFP) transceivers and 10/100/1000Base-T Ethernet connectors.



Figure 2-1: EX2200



Figure 2-2: EX2200-C

2.2 Description of Field Replaceable Units (FRU)

The transceivers are hot-removable and hot-insertable: You can remove and replace them without powering off the switch or disrupting switch functions.

None of these components contain NV RAM. All NV RAM is soldered to the system board.

3 POWER DOWN AND REMOVAL OF NON-VOLATILE STORAGE

In order to ensure that no user data or system configurations remain resident on an EX2200 or EX2200-C platform, the following steps must be performed:

1. Power must be removed from the system to clear all volatile storage
2. The FLASH chip must be removed from the system board

A detailed process is included in the following sections.

3.1 System Power Down

Power down the system by setting the switch on each installed unit to the “off” position. Remove any connected power cords.

3.2 Disassembly of the EX2200 Chassis and Identification of NV storage

The EX2200 does not contain NV storage that is replaceable as it is soldered to the system board. In order to access the memory for removal, refer to the following steps:

1. Remove the four screws from the top of the system (Figure 3-1)

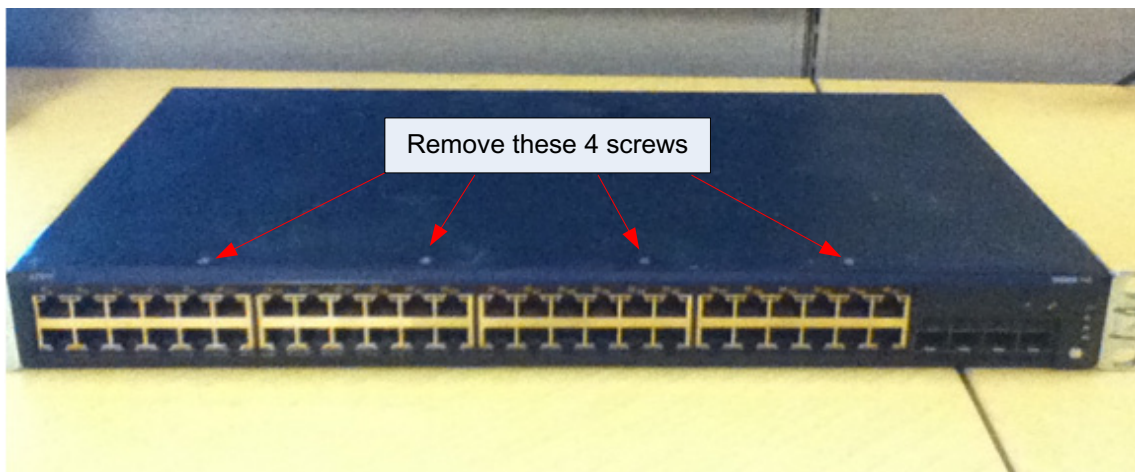

Figure 3-1: EX2200 Top side screws

2. Remove five screws from left side of chassis (Figure 3-2)

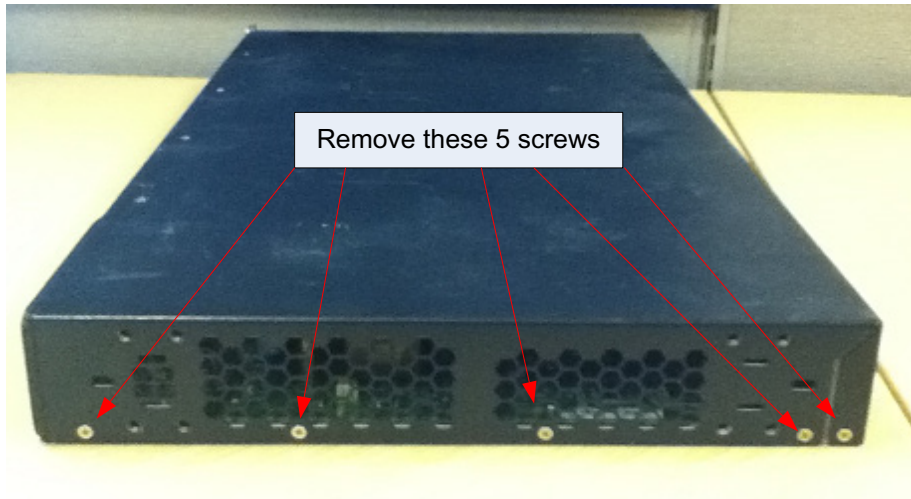

Figure 3-2: EX2200 Left side screws

3. Remove four screws from right side of chassis (Figure 3-3)

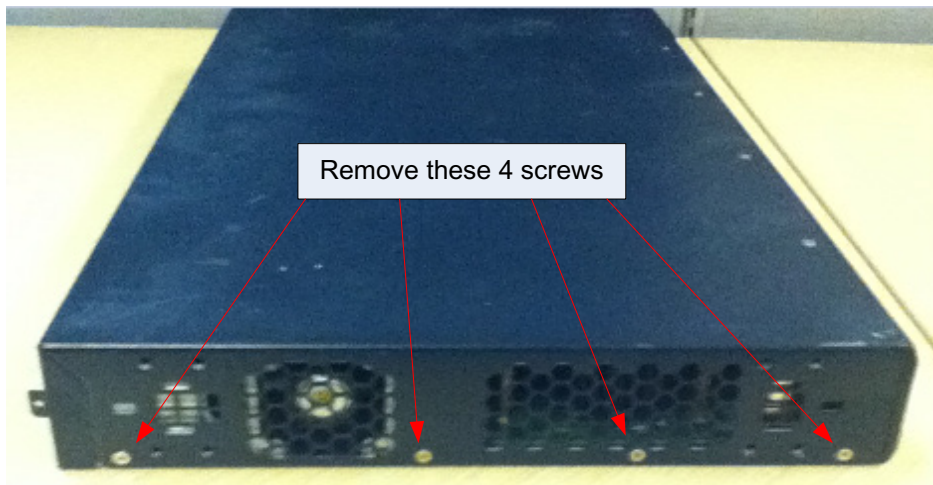

Figure 3-3: EX2200 Right side screws

4. Remove nine screws from rear of chassis (figure 3-4)

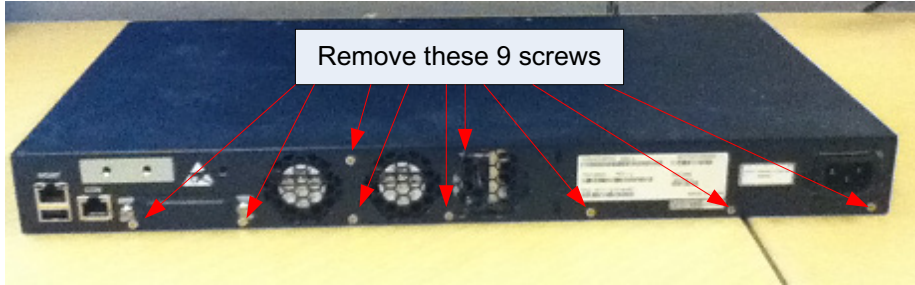

Figure 3-4: EX2200 Rear screws

5. Remove the top of the chassis (Figure 3-5)

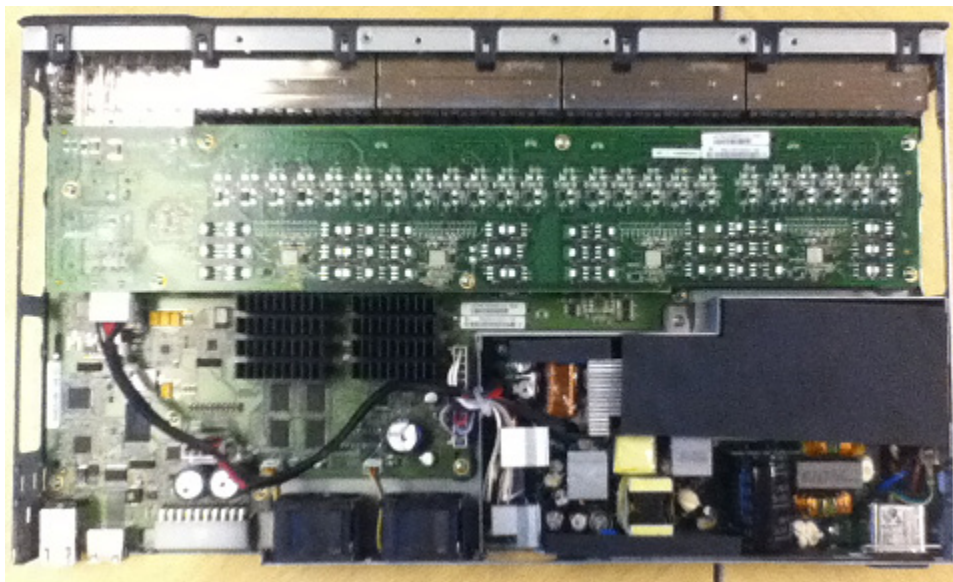

Figure 3-5: EX2200 Open Chassis

6. Locate NV storage (Figure 3-6)

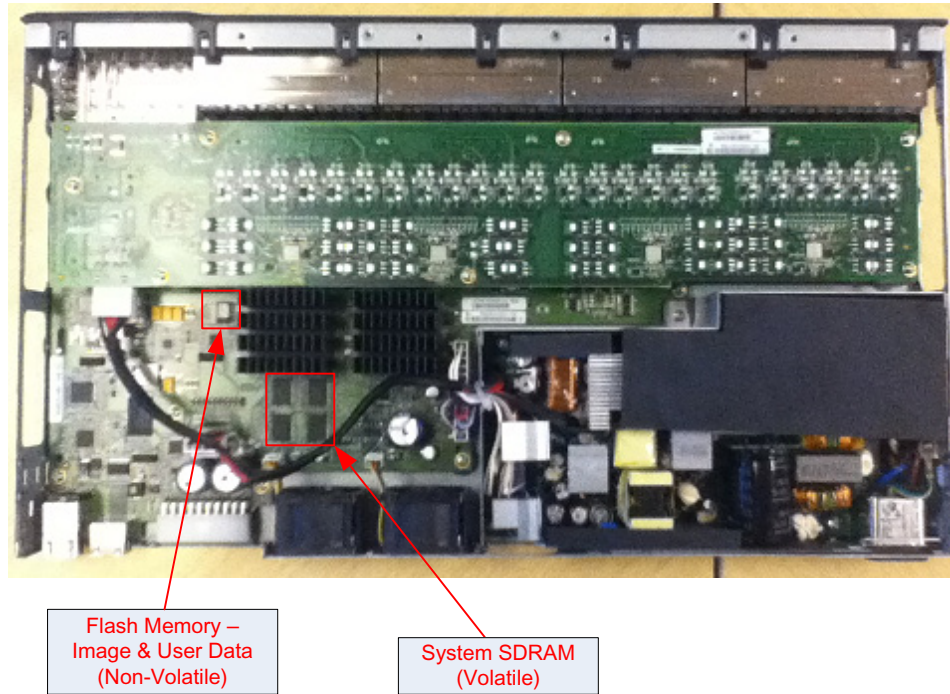

Figure 3-6: EX2200 Locate NV Storage (Flash)

3.3 Disassembly of the EX2200-C Chassis and Identification of NV storage

The EX2200-C does not contain NV storage that is replaceable as it is soldered to the system board. In order to access the memory for removal, refer to the following steps:

1. Remove the ten screws from the top of the system (Figure 3-7)

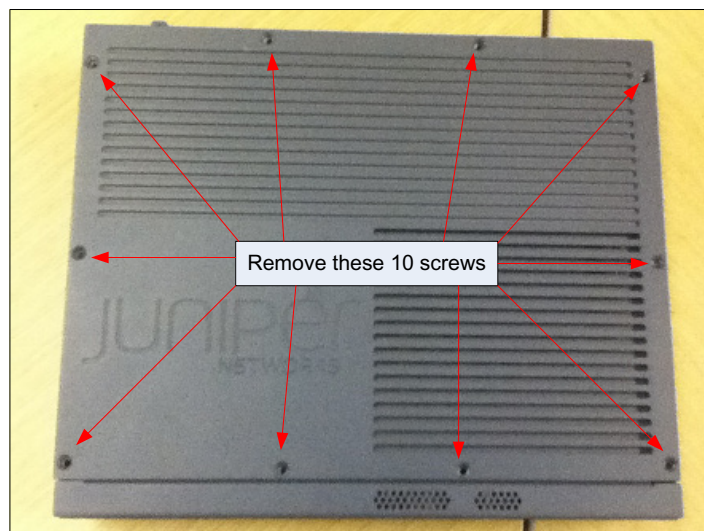

Figure 3-7: EX2200-C Top side screws

2. Remove the top of the chassis (Figure 3-8)



Figure 3-8: EX2200-C Open Chassis

3. Locate NV storage (Figure 3-9)

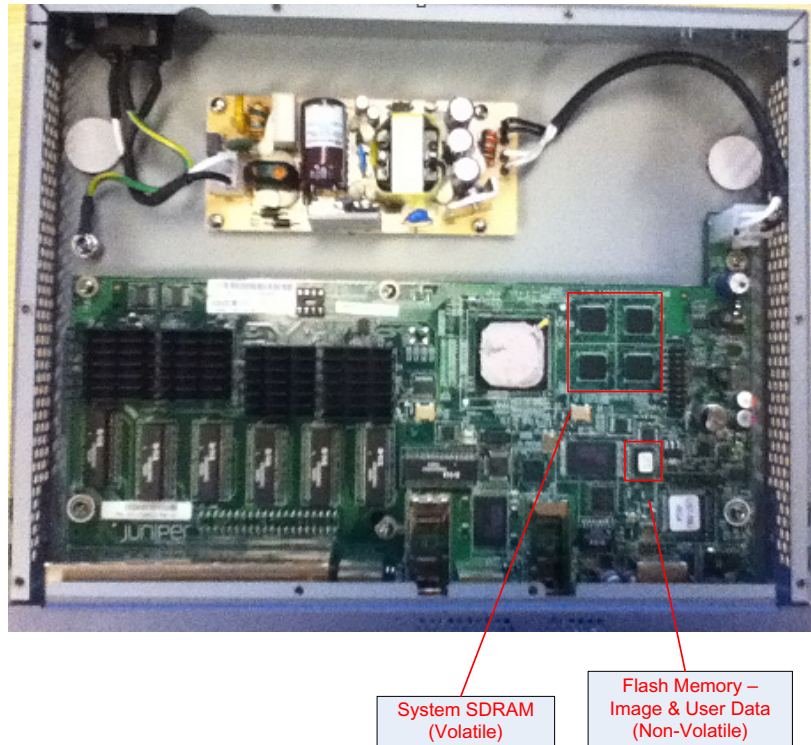

Figure 3-9: EX2200-C Locate NV Storage (Flash)

3.4 Removal of the FLASH Chip from the System Board

Once the NV storage has been located, utilize a screwdriver or other means to remove it from the system board.

NOTE : Before removal, ensure J-TAC and the appropriate account team have been notified of your intentions.