

Cisco 850 Series and Cisco 870 Series Access Routers Hardware Installation Guide

Corporate Headquarters

Cisco Systems, Inc.
170 West Tasman Drive
San Jose, CA 95134-1706
USA
<http://www.cisco.com>
Tel: 408 526-4000
800 553-NETS (6387)
Fax: 408 526-4100



THE SPECIFICATIONS AND INFORMATION REGARDING THE PRODUCTS IN THIS MANUAL ARE SUBJECT TO CHANGE WITHOUT NOTICE. ALL STATEMENTS, INFORMATION, AND RECOMMENDATIONS IN THIS MANUAL ARE BELIEVED TO BE ACCURATE BUT ARE PRESENTED WITHOUT WARRANTY OF ANY KIND, EXPRESS OR IMPLIED. USERS MUST TAKE FULL RESPONSIBILITY FOR THEIR APPLICATION OF ANY PRODUCTS.

THE SOFTWARE LICENSE AND LIMITED WARRANTY FOR THE ACCOMPANYING PRODUCT ARE SET FORTH IN THE INFORMATION PACKET THAT SHIPPED WITH THE PRODUCT AND ARE INCORPORATED HEREIN BY THIS REFERENCE. IF YOU ARE UNABLE TO LOCATE THE SOFTWARE LICENSE OR LIMITED WARRANTY, CONTACT YOUR CISCO REPRESENTATIVE FOR A COPY.

The following information is for FCC compliance of Class A devices: This equipment has been tested and found to comply with the limits for a Class A digital device, pursuant to part 15 of the FCC rules. These limits are designed to provide reasonable protection against harmful interference when the equipment is operated in a commercial environment. This equipment generates, uses, and can radiate radio-frequency energy and, if not installed and used in accordance with the instruction manual, may cause harmful interference to radio communications. Operation of this equipment in a residential area is likely to cause harmful interference, in which case users will be required to correct the interference at their own expense.

The following information is for FCC compliance of Class B devices: The equipment described in this manual generates and may radiate radio-frequency energy. If it is not installed in accordance with Cisco's installation instructions, it may cause interference with radio and television reception. This equipment has been tested and found to comply with the limits for a Class B digital device in accordance with the specifications in part 15 of the FCC rules. These specifications are designed to provide reasonable protection against such interference in a residential installation. However, there is no guarantee that interference will not occur in a particular installation.

Modifying the equipment without Cisco's written authorization may result in the equipment no longer complying with FCC requirements for Class A or Class B digital devices. In that event, your right to use the equipment may be limited by FCC regulations, and you may be required to correct any interference to radio or television communications at your own expense.

You can determine whether your equipment is causing interference by turning it off. If the interference stops, it was probably caused by the Cisco equipment or one of its peripheral devices. If the equipment causes interference to radio or television reception, try to correct the interference by using one or more of the following measures:

- Turn the television or radio antenna until the interference stops.
- Move the equipment to one side or the other of the television or radio.
- Move the equipment farther away from the television or radio.
- Plug the equipment into an outlet that is on a different circuit from the television or radio. (That is, make certain the equipment and the television or radio are on circuits controlled by different circuit breakers or fuses.)

Modifications to this product not authorized by Cisco Systems, Inc. could void the FCC approval and negate your authority to operate the product.

The Cisco implementation of TCP header compression is an adaptation of a program developed by the University of California, Berkeley (UCB) as part of UCB's public domain version of the UNIX operating system. All rights reserved. Copyright © 1981, Regents of the University of California.

NOTWITHSTANDING ANY OTHER WARRANTY HEREIN, ALL DOCUMENT FILES AND SOFTWARE OF THESE SUPPLIERS ARE PROVIDED "AS IS" WITH ALL FAULTS. CISCO AND THE ABOVE-NAMED SUPPLIERS DISCLAIM ALL WARRANTIES, EXPRESSED OR IMPLIED, INCLUDING, WITHOUT LIMITATION, THOSE OF MERCHANTABILITY, FITNESS FOR A PARTICULAR PURPOSE AND NONINFRINGEMENT OR ARISING FROM A COURSE OF DEALING, USAGE, OR TRADE PRACTICE.

IN NO EVENT SHALL CISCO OR ITS SUPPLIERS BE LIABLE FOR ANY INDIRECT, SPECIAL, CONSEQUENTIAL, OR INCIDENTAL DAMAGES, INCLUDING, WITHOUT LIMITATION, LOST PROFITS OR LOSS OR DAMAGE TO DATA ARISING OUT OF THE USE OR INABILITY TO USE THIS MANUAL, EVEN IF CISCO OR ITS SUPPLIERS HAVE BEEN ADVISED OF THE POSSIBILITY OF SUCH DAMAGES.

CCSP, the Cisco Square Bridge logo, Follow Me Browsing, and StackWise are trademarks of Cisco Systems, Inc.; Changing the Way We Work, Live, Play, and Learn, and iQuick Study are service marks of Cisco Systems, Inc.; and Access Registrar, Aironet, ASIST, BPX, Catalyst, CCDA, CCDP, CCIE, CCIP, CCNA, CCNP, Cisco, the Cisco Certified Internetwork Expert logo, Cisco IOS, Cisco Press, Cisco Systems, Cisco Systems Capital, the Cisco Systems logo, Cisco Unity, Empowering the Internet Generation, Enterprise/Solver, EtherChannel, EtherFast, EtherSwitch, Fast Step, FormShare, GigaDrive, GigaStack, HomeLink, Internet Quotient, IOS, IP/TV, iQ Expertise, the iQ logo, iQ Net Readiness Scorecard, LightStream, Linksys, MeetingPlace, MGX, the Networkers logo, Networking Academy, Network Registrar, Packet, PIX, Post-Routing, Pre-Routing, ProConnect, RateMUX, ScriptShare, SlideCast, SMARTnet, StrataView Plus, SwitchProbe, TeleRouter, The Fastest Way to Increase Your Internet Quotient, TransPath, and VCO are registered trademarks of Cisco Systems, Inc. and/or its affiliates in the United States and certain other countries.

All other trademarks mentioned in this document or Website are the property of their respective owners. The use of the word partner does not imply a partnership relationship between Cisco and any other company. (0501R)



Preface 7

- Objective 1-7
- Audience 1-7
- Organization 1-8
- Conventions 1-8
- Related Documentation 1-14
- Obtaining Documentation and Submitting a Service Request 1-14

CHAPTER 1

Product Overview 1-1

- General Descriptions of the Router Models 1-1
 - Cisco 851 and Cisco 871 Ethernet-to-Ethernet Routers 1-1
 - Router Ports on the Cisco 851 and Cisco 871 Back Panel 1-3
 - USB Port Power Allocation on the Cisco 871 Router 1-3
 - Cisco 857 and Cisco 877 ADSL-over-POTS Routers 1-3
 - Router Ports on the Cisco 857 and Cisco 877 Back Panel 1-5
 - Cisco 876 ADSL-over-ISDN Router 1-5
 - Router Ports on the Cisco 876 Back Panel 1-6
 - Cisco 878 SHDSL Router 1-6
 - Router Ports on the Cisco 878 Back Panel 1-7
- Feature Summary 1-7
- Hardware Features 1-9
 - Serial Number Location 1-9
 - LED Indicators on the Routers 1-9
 - Integrated 802.11b/g Radio Module (Wireless Models Only) 1-11
 - Supported Cisco Radio Antennas (Wireless Models Only) 1-12
 - External Power-over-Ethernet Module (Optional) 1-12
 - LED Indicators on the PoE Module 1-16
 - Router Memory 1-16
 - Router Hardware Security 1-17
- Regulatory Compliance 1-17

CHAPTER 2

Preinstallation Information 2-1

- Safety Warnings and Guidelines 2-1
 - Additional Warnings for Wireless Routers 2-3

General Safety Guidelines for Wireless Routers 2-3
 Preventing Electrostatic Discharge Damage 2-3
 Preventing Damage to the Router 2-4
 Unpacking the Box 2-4
 Preparing for Installation 2-5
 What to Do Next 2-6

CHAPTER 3

Router and PoE Module Mounting Procedures 3-1

Connecting Antennas to the Wireless Router 3-1
 Mounting on a Table 3-1
 Mounting on a Wall 3-2
 Guidelines for Wall Mounting 3-2
 Mounting the Router on a Wall 3-2
 Mounting the PoE Module on a Wall 3-5
 What to Do Next 3-6

CHAPTER 4

Router Cabling Procedures 4-1

Cabling for Nonwireless Routers 4-2
 Typical Installations 4-2
 Connecting the Radio Antennas to the Wireless Router 4-6
 Connecting the Power-over-Ethernet Module (Optional) 4-7
 Connecting a Server, PC, or Workstation 4-8
 Connecting an External Ethernet Switch (Optional) 4-9
 Connecting a Broadband Modem 4-11
 Connecting a Terminal or PC to the Console Port 4-12
 Connecting an Async Modem to the Console Port 4-13
 Connecting an ISDN S/T Port 4-14
 Connecting an ADSL Line—ADSLoPOTS Port 4-16
 Connecting an ADSL Line—ADSLoISDN Port 4-17
 Connecting a G.SHDSL Line 4-18
 Connecting the AC Adapter 4-19
 Verifying Router Operations 4-21
 What to Do Next 4-22

CHAPTER 5

Initial Configuration 5-1

Installing Cisco Router and Security Device Manager 5-1

Initial Configuration Using Cisco SDM	5-1
Initial Configuration Using the Setup Command Facility	5-2
Initial Configuration Using the Cisco CLI—Manual Configuration	5-4
Verifying the Initial Configuration	5-5
What to Do Next	5-5

CHAPTER 6**Troubleshooting 6-1**

Before You Call Your Cisco Reseller	6-1
Problems During First Startup	6-2
Problems After the Router Is Running	6-3

APPENDIX A**Specifications A-1**

Router Specifications	A-1
Power-over-Ethernet Module Specifications	A-2
LAN Port Pinouts	A-3
Console Connector Pinouts	A-4
ADSL Port Connector Pinouts	A-4
Cable Specifications	A-5
Ethernet Cable Specifications	A-5
Maximum Cable Length	A-5

INDEX



Preface

This preface describes the objectives, audience, organization, and conventions of this guide, and describes related documents that have additional information. It contains the following sections:

- [Objective, page 7](#)
- [Audience, page 7](#)
- [Organization, page 8](#)
- [Conventions, page 8](#)
- [Related Documentation, page 14](#)
- [Obtaining Documentation and Submitting a Service Request, page 14](#)

Objective

This guide explains how to install, maintain, and troubleshoot your router hardware.

This guide describes the wireless and nonwireless Cisco 850 series and Cisco 870 series router models. Some information may not apply to your particular router model.

For warranty, service, and support information, see the “Cisco One-Year Limited Hardware Warranty Terms” section in the *Cisco 850 Series and Cisco 870 Series Access Routers Cabling and Setup Quick Start Guide* that was shipped with your router.

Audience

This guide is intended for service technicians who have little or no experience in installing routers and whose goal is to connect the router to the network as quickly as possible.

Organization

This guide contains the following information:

Chapter 1, “Product Overview”	Describes the router hardware and features.
Chapter 2, “Preinstallation Information”	Provides preinstallation information, including safety warnings and guidelines, and information about the items shipped with your router.
Chapter 3, “Router and PoE Module Mounting Procedures”	Describes how to mount the router before connecting devices to the router.
Chapter 4, “Router Cabling Procedures”	Provides information about connecting the router to various devices, mounting the router, and powering up the router and the connected devices.
Chapter 5, “Initial Configuration”	Provides the procedures for initially configuring the router settings.
Chapter 6, “Troubleshooting”	Describes problems that might develop and how to identify and solve them.
Appendix A, “Specifications”	Provides product specifications, port connector pinouts, and specifications for cables that you might need to supply.

Conventions

This section describes the conventions used in this guide.



Note

Means *reader take note*. Notes contain helpful suggestions or references to additional information and material.



Caution

This symbol means *reader be careful*. In this situation, you might do something that could result in equipment damage or loss of data.



Warning

IMPORTANT SAFETY INSTRUCTIONS

This warning symbol means danger. You are in a situation that could cause bodily injury. Before you work on any equipment, be aware of the hazards involved with electrical circuitry and be familiar with standard practices for preventing accidents. Use the statement number provided at the end of each warning to locate its translation in the translated safety warnings that accompanied this device. Statement 1071

SAVE THESE INSTRUCTIONS

Waarschuwing

BELANGRIJKE VEILIGHEIDSINSTRUCTIES

Dit waarschuwingssymbool betekent gevaar. U verkeert in een situatie die lichamelijk letsel kan veroorzaken. Voordat u aan enige apparatuur gaat werken, dient u zich bewust te zijn van de bij elektrische schakelingen betrokken risico's en dient u op de hoogte te zijn van de standaard praktijken om ongelukken te voorkomen. Gebruik het nummer van de verklaring onderaan de waarschuwing als u een vertaling van de waarschuwing die bij het apparaat wordt geleverd, wilt raadplegen.

BEWAAR DEZE INSTRUCTIES

Varoitus

TÄRKEITÄ TURVALLISUUSOHJEITA

Tämä varoitusmerkki merkitsee vaaraa. Tilanne voi aiheuttaa ruumiillisia vammoja. Ennen kuin käsittelet laitteistoa, huomioi sähköpiirien käsittelyyn liittyvät riskit ja tutustu onnettomuuksien yleisiin ehkäisytapoihin. Turvallisuusvaroitusten käännökset löytyvät laitteen mukana toimitettujen käännettyjen turvallisuusvaroitusten joukosta varoitusten lopussa näkyvien lausuntonumeroiden avulla.

SÄILYTÄ NÄMÄ OHJEET

Attention

IMPORTANTES INFORMATIONS DE SÉCURITÉ

Ce symbole d'avertissement indique un danger. Vous vous trouvez dans une situation pouvant entraîner des blessures ou des dommages corporels. Avant de travailler sur un équipement, soyez conscient des dangers liés aux circuits électriques et familiarisez-vous avec les procédures couramment utilisées pour éviter les accidents. Pour prendre connaissance des traductions des avertissements figurant dans les consignes de sécurité traduites qui accompagnent cet appareil, référez-vous au numéro de l'instruction situé à la fin de chaque avertissement.

CONSERVEZ CES INFORMATIONS

Warnung

WICHTIGE SICHERHEITSHINWEISE

Dieses Warnsymbol bedeutet Gefahr. Sie befinden sich in einer Situation, die zu Verletzungen führen kann. Machen Sie sich vor der Arbeit mit Geräten mit den Gefahren elektrischer Schaltungen und den üblichen Verfahren zur Vorbeugung vor Unfällen vertraut. Suchen Sie mit der am Ende jeder Warnung angegebenen Anweisungsnummer nach der jeweiligen Übersetzung in den übersetzten Sicherheitshinweisen, die zusammen mit diesem Gerät ausgeliefert wurden.

BEWAHREN SIE DIESE HINWEISE GUT AUF.

Avvertenza IMPORTANTI ISTRUZIONI SULLA SICUREZZA

Questo simbolo di avvertenza indica un pericolo. La situazione potrebbe causare infortuni alle persone. Prima di intervenire su qualsiasi apparecchiatura, occorre essere al corrente dei pericoli relativi ai circuiti elettrici e conoscere le procedure standard per la prevenzione di incidenti. Utilizzare il numero di istruzione presente alla fine di ciascuna avvertenza per individuare le traduzioni delle avvertenze riportate in questo documento.

CONSERVARE QUESTE ISTRUZIONI**Advarsel VIKTIGE SIKKERHETSINSTRUKSJONER**

Dette advarselssymbolet betyr fare. Du er i en situasjon som kan føre til skade på person. Før du begynner å arbeide med noe av utstyret, må du være oppmerksom på farene forbundet med elektriske kretser, og kjenne til standardprosedyrer for å forhindre ulykker. Bruk nummeret i slutten av hver advarsel for å finne oversettelsen i de oversatte sikkerhetsadvarslene som fulgte med denne enheten.

TA VARE PÅ DISSE INSTRUKSJONENE**Aviso INSTRUÇÕES IMPORTANTES DE SEGURANÇA**

Este símbolo de aviso significa perigo. Você está em uma situação que poderá ser causadora de lesões corporais. Antes de iniciar a utilização de qualquer equipamento, tenha conhecimento dos perigos envolvidos no manuseio de circuitos elétricos e familiarize-se com as práticas habituais de prevenção de acidentes. Utilize o número da instrução fornecido ao final de cada aviso para localizar sua tradução nos avisos de segurança traduzidos que acompanham este dispositivo.

GUARDE ESTAS INSTRUÇÕES**¡Advertencia! INSTRUCCIONES IMPORTANTES DE SEGURIDAD**

Este símbolo de aviso indica peligro. Existe riesgo para su integridad física. Antes de manipular cualquier equipo, considere los riesgos de la corriente eléctrica y familiarícese con los procedimientos estándar de prevención de accidentes. Al final de cada advertencia encontrará el número que le ayudará a encontrar el texto traducido en el apartado de traducciones que acompaña a este dispositivo.

GUARDE ESTAS INSTRUCCIONES**Varning! VIKTIGA SÄKERHETSANVISNINGAR**

Denna varningssignal signalerar fara. Du befinner dig i en situation som kan leda till personskada. Innan du utför arbete på någon utrustning måste du vara medveten om farorna med elkretsar och känna till vanliga förfaranden för att förebygga olyckor. Använd det nummer som finns i slutet av varje varning för att hitta dess översättning i de översatta säkerhetsvarningar som medföljer denna anordning.

SPARA DESSA ANVISNINGAR

FONTOS BIZTONSÁGI ELOÍRÁSOK

Ez a figyelmeztető jel veszélyre utal. Sérülésveszélyt rejtő helyzetben van. Mielott bármely berendezésen munkát végezte, legyen figyelemmel az elektromos áramkörök okozta kockázatokra, és ismerkedjen meg a szokásos balesetvédelmi eljárásokkal. A kiadványban szereplő figyelmeztetések fordítása a készülékhez mellékelt biztonsági figyelmeztetések között található; a fordítás az egyes figyelmeztetések végén látható szám alapján kereshető meg.

ORIZZE MEG EZEKET AZ UTASÍTÁSOKAT!

Предупреждение

ВАЖНЫЕ ИНСТРУКЦИИ ПО СОБЛЮДЕНИЮ ТЕХНИКИ БЕЗОПАСНОСТИ

Этот символ предупреждения обозначает опасность. То есть имеет место ситуация, в которой следует опасаться телесных повреждений. Перед эксплуатацией оборудования выясните, каким опасностям может подвергаться пользователь при использовании электрических цепей, и ознакомьтесь с правилами техники безопасности для предотвращения возможных несчастных случаев. Воспользуйтесь номером заявления, приведенным в конце каждого предупреждения, чтобы найти его переведенный вариант в переводе предупреждений по безопасности, прилагаемом к данному устройству.

СОХРАНИТЕ ЭТИ ИНСТРУКЦИИ

警告

重要的安全性说明

此警告符号代表危险。您正处于可能受到严重伤害的工作环境中。在您使用设备开始工作之前，必须充分意识到触电的危险，并熟练掌握防止事故发生的标准工作程序。请根据每项警告结尾提供的声明号码来找到此设备的安全性警告说明的翻译文本。

请保存这些安全性说明

警告

安全上の重要な注意事項

「危険」の意味です。人身事故を予防するための注意事項が記述されています。装置の取り扱い作業を行うときは、電気回路の危険性に注意し、一般的な事故防止策に留意してください。警告の各国語版は、各注意事項の番号を基に、装置に付属の「Translated Safety Warnings」を参照してください。

これらの注意事項を保管しておいてください。

주의

중요 안전 지침

이 경고 기호는 위험을 나타냅니다. 작업자가 신체 부상을 일으킬 수 있는 위험한 환경에 있습니다. 장비에 작업을 수행하기 전에 전기 회로와 관련된 위험을 숙지하고 표준 작업 관례를 숙지하여 사고를 방지하십시오. 각 경고의 마지막 부분에 있는 경고문 번호를 참조하여 이 장치와 함께 제공되는 번역된 안전 경고문에서 해당 번역문을 찾으십시오.

이 지시 사항을 보관하십시오.

Aviso INSTRUÇÕES IMPORTANTES DE SEGURANÇA

Este símbolo de aviso significa perigo. Você se encontra em uma situação em que há risco de lesões corporais. Antes de trabalhar com qualquer equipamento, esteja ciente dos riscos que envolvem os circuitos elétricos e familiarize-se com as práticas padrão de prevenção de acidentes. Use o número da declaração fornecido ao final de cada aviso para localizar sua tradução nos avisos de segurança traduzidos que acompanham o dispositivo.

GUARDE ESTAS INSTRUÇÕES**Advarsel VIGTIGE SIKKERHEDSANVISNINGER**

Dette advarselssymbol betyder fare. Du befinder dig i en situation med risiko for legemeskade. Før du begynder arbejde på udstyr, skal du være opmærksom på de involverede risici, der er ved elektriske kredsløb, og du skal sætte dig ind i standardprocedurer til undgåelse af ulykker. Brug erklæringsnummeret efter hver advarsel for at finde oversættelsen i de oversatte advarsler, der fulgte med denne enhed.

GEM DISSE ANVISNINGER

تحذير

إرشادات الأمان الهامة

يوضح رمز التحذير هذا وجود خطر. وهذا يعني أنك متواجد في مكان قد ينتج عنه التعرض لإصابات. قبل بدء العمل، احذر مخاطر التعرض للصدمات الكهربائية وكن على علم بالإجراءات القياسية للحيلولة دون وقوع أي حوادث. استخدم رقم البيان الموجود في آخر كل تحذير لتحديد مكان ترجمته داخل تحذيرات الأمان المترجمة التي تأتي مع الجهاز. قم بحفظ هذه الإرشادات

Upozorenje VAŽNE SIGURNOSNE NAPOMENE

Ovaj simbol upozorenja predstavlja opasnost. Nalazite se u situaciji koja može prouzročiti tjelesne ozljede. Prije rada s bilo kojim uređajem, morate razumjeti opasnosti vezane uz električne sklopove, te biti upoznati sa standardnim načinima izbjegavanja nesreća. U prevedenim sigurnosnim upozorenjima, priloženima uz uređaj, možete prema broju koji se nalazi uz pojedino upozorenje pronaći i njegov prijevod.

SAČUVAJTE OVE UPUTE**Upozornění DŮLEŽITÉ BEZPEČNOSTNÍ POKYNY**

Tento upozorňující symbol označuje nebezpečí. Jste v situaci, která by mohla způsobit nebezpečí úrazu. Před prací na jakémkoliv vybavení si uvědomte nebezpečí související s elektrickými obvody a seznamte se se standardními opatřeními pro předcházení úrazům. Podle čísla na konci každého upozornění vyhledejte jeho překlad v přeložených bezpečnostních upozorněních, která jsou přiložena k zařízení.

USCHOVEJTE TYTO POKYNY

Προειδοποίηση	<p>ΣΗΜΑΝΤΙΚΕΣ ΟΔΗΓΙΕΣ ΑΣΦΑΛΕΙΑΣ</p> <p>Αυτό το προειδοποιητικό σύμβολο σημαίνει κίνδυνο. Βρίσκεστε σε κατάσταση που μπορεί να προκαλέσει τραυματισμό. Πριν εργαστείτε σε οποιοδήποτε εξοπλισμό, να έχετε υπόψη σας τους κινδύνους που σχετίζονται με τα ηλεκτρικά κυκλώματα και να έχετε εξοικειωθεί με τις συνήθεις πρακτικές για την αποφυγή ατυχημάτων. Χρησιμοποιήστε τον αριθμό δήλωσης που παρέχεται στο τέλος κάθε προειδοποίησης, για να εντοπίσετε τη μετάφρασή της στις μεταφρασμένες προειδοποιήσεις ασφαλείας που συνοδεύουν τη συσκευή.</p> <p>ΦΥΛΑΞΤΕ ΑΥΤΕΣ ΤΙΣ ΟΔΗΓΙΕΣ</p>
אזהרה	<p>הוראות בטיחות חשובות</p> <p>סימן אזהרה זה מסמל סכנה. אתה נמצא במצב העלול לגרום לפציעה. לפני שתעבוד עם ציוד כלשהו, עליך להיות מודע לסכנות הכרוכות במעגלים חשמליים ולהכיר את הנהלים המקובלים למניעת תאונות. השתמש במספר ההוראה המסופק בסופה של כל אזהרה כדי לאתר את התרגום באזהרות הבטיחות המתורגמות שמצורפות להתקן.</p> <p>שמור הוראות אלה</p>
Opomena	<p>ВАЖНИ БЕЗБЕДНОСНИ НАПАТСТВИЈА</p> <p>Симболот за предупредување значи опасност. Се наоѓате во ситуација што може да предизвика телесни повреди. Пред да работите со опремата, бидете свесни за ризикот што постои кај електричните кола и треба да ги познавате стандардните постапки за спречување на несреќни случаи. Искористете го бројот на изјавата што се наоѓа на крајот на секое предупредување за да го најдете неговиот период во преведените безбедносни предупредувања што се испорачани со уредот.</p> <p>ЧУВАЈТЕ ГИ ОБИЕ НАПАТСТВИЈА</p>
Ostrzeżenie	<p>WAŻNE INSTRUKCJE DOTYCZĄCE BEZPIECZEŃSTWA</p> <p>Ten symbol ostrzeżenia oznacza niebezpieczeństwo. Zachodzi sytuacja, która może powodować obrażenia ciała. Przed przystąpieniem do prac przy urządzeniach należy zapoznać się z zagrożeniami związanymi z układami elektrycznymi oraz ze standardowymi środkami zapobiegania wypadkom. Na końcu każdego ostrzeżenia podano numer, na podstawie którego można odszukać tłumaczenie tego ostrzeżenia w dołączonym do urządzenia dokumencie z tłumaczeniami ostrzeżeń.</p> <p>NINIEJSZE INSTRUKCJE NALEŻY ZACHOWAĆ</p>
Upozornenie	<p>DÔLEŽITÉ BEZPEČNOSTNÉ POKYNY</p> <p>Tento varovný symbol označuje nebezpečenstvo. Nachádzate sa v situácii s nebezpečenstvom úrazu. Pred prácou na akomkoľvek vybavení si uvedomte nebezpečenstvo súvisiace s elektrickými obvodmi a oboznámte sa so štandardnými opatreniami na predchádzanie úrazom. Podľa čísla na konci každého upozornenia vyhľadajte jeho preklad v preložených bezpečnostných upozorneniach, ktoré sú priložené k zariadeniu.</p> <p>USCHOVAJTE SI TENTO NÁVOD</p>

Related Documentation

In addition to the *Cisco 850 Series and Cisco 870 Series Routers Hardware Installation Guide* (this document), the Cisco 850 series and Cisco 870 series routers document set includes the following:

- *Cisco 850 Series and Cisco 870 Series Access Routers Cabling and Setup Quick Start Guide*
- *Cisco 850 Series and Cisco 870 Series Access Routers Software Configuration Guide*
- *Cisco Access Router Wireless Configuration Guide*
- *Regulatory Compliance and Safety Information for Cisco 800 Series and SOHO Series Routers*
- *Declarations of Conformity and Regulatory Information for Cisco Access Products with 802.11a/b/g and 802.11b/g Radios*
- *Upgrading Memory in Cisco 800 Routers*
- The latest version of the *Cisco IOS Release Notes*

You might also need to refer to the following documents:

- *Cisco Router and Security Device Manager (SDM) Quick Start Guide*
- *Cisco IOS Release 12.3 Quality of Service Solutions Configuration Guide*
- *Cisco IOS Security Configuration Guide, Release 12.3*

Obtaining Documentation and Submitting a Service Request

For information on obtaining documentation, submitting a service request, and gathering additional information, see the monthly *What's New in Cisco Product Documentation*, which also lists all new and revised Cisco technical documentation, at:

<http://www.cisco.com/en/US/docs/general/whatsnew/whatsnew.html>

Subscribe to the *What's New in Cisco Product Documentation* as a Really Simple Syndication (RSS) feed and set content to be delivered directly to your desktop using a reader application. The RSS feeds are a free service and Cisco currently supports RSS Version 2.0.



Product Overview

This chapter provides an overview of the hardware features for the Cisco 851, Cisco 857, Cisco 871, Cisco 876, Cisco 877, and Cisco 878 routers. It contains the following sections:

- [General Descriptions of the Router Models, page 1-1](#)
- [Feature Summary, page 1-7](#)
- [Hardware Features, page 1-9](#)
- [Regulatory Compliance, page 1-17](#)

General Descriptions of the Router Models

This section provides a general description of each of the router models.

- [Cisco 851 and Cisco 871 Ethernet-to-Ethernet Routers](#)
- [Cisco 857 and Cisco 877 ADSL-over-POTS Routers](#)
- [Cisco 876 ADSL-over-ISDN Router](#)
- [Cisco 878 SHDSL Router](#)

Cisco 851 and Cisco 871 Ethernet-to-Ethernet Routers

The Cisco 851 and Cisco 871 Ethernet-to-Ethernet routers can connect a corporate teleworker or a small office to an Internet service provider (ISP) over a broadband or Ethernet connection to a corporate LAN or to the Internet. The Cisco 851 and Cisco 871 routers are switch-capable routers that provide a 4-port Ethernet switch for the LAN. These routers are capable of bridging and multiprotocol routing between LAN and WAN ports.

Universal Serial Bus (USB) ports on the Cisco 871 router provide connection for USB devices such as security tokens, flash memory sticks, and printers.

The front panels of the Cisco 851 and Cisco 871 routers are identical. (See [Figure 1-1](#).) [Figure 1-2](#) shows the back panel of the Cisco 851 router, and [Figure 1-3](#) shows the back panel of the Cisco 871 router.

The Cisco 851 wireless model supports the use of a single 2.4-GHz antenna (see [Figure 1-2](#)), and the Cisco 871 wireless model supports the use of two 2.4-GHz antennas (see [Figure 1-3](#)).

Figure 1-1 Cisco 851 and Cisco 871 Router Front Panel

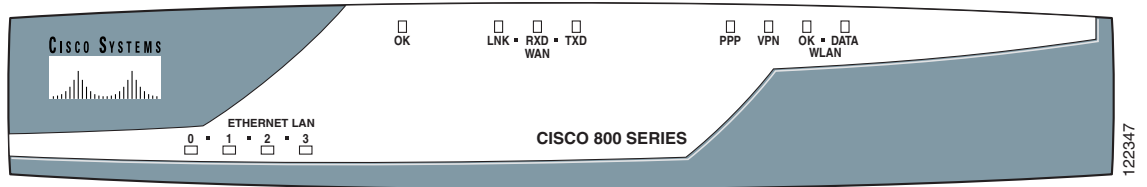

Figure 1-2 Cisco 851 Router Back Panel

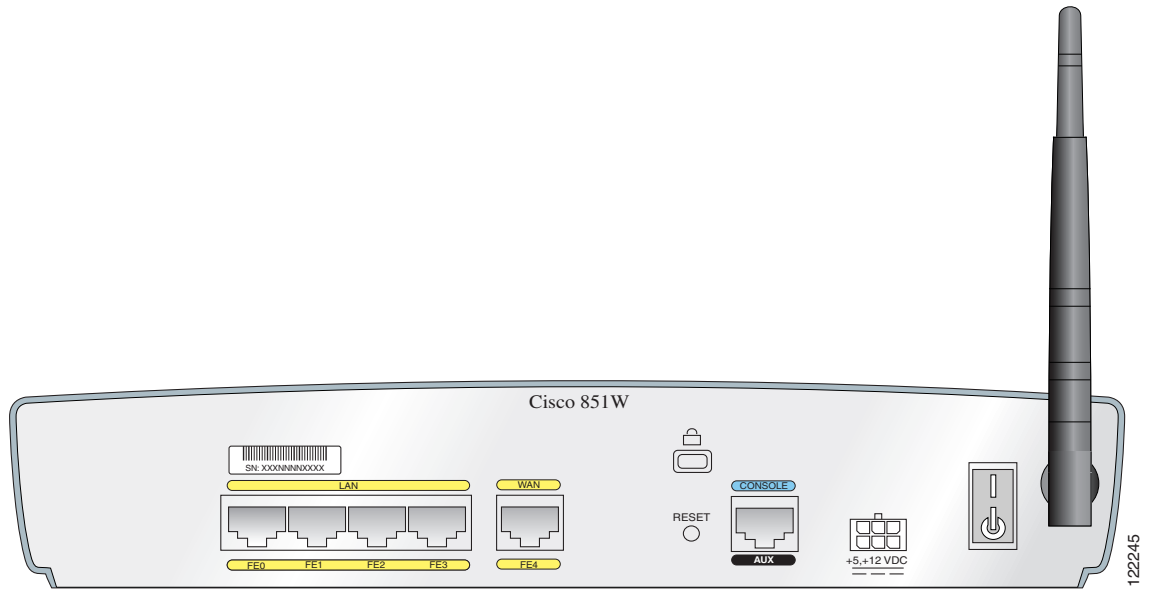
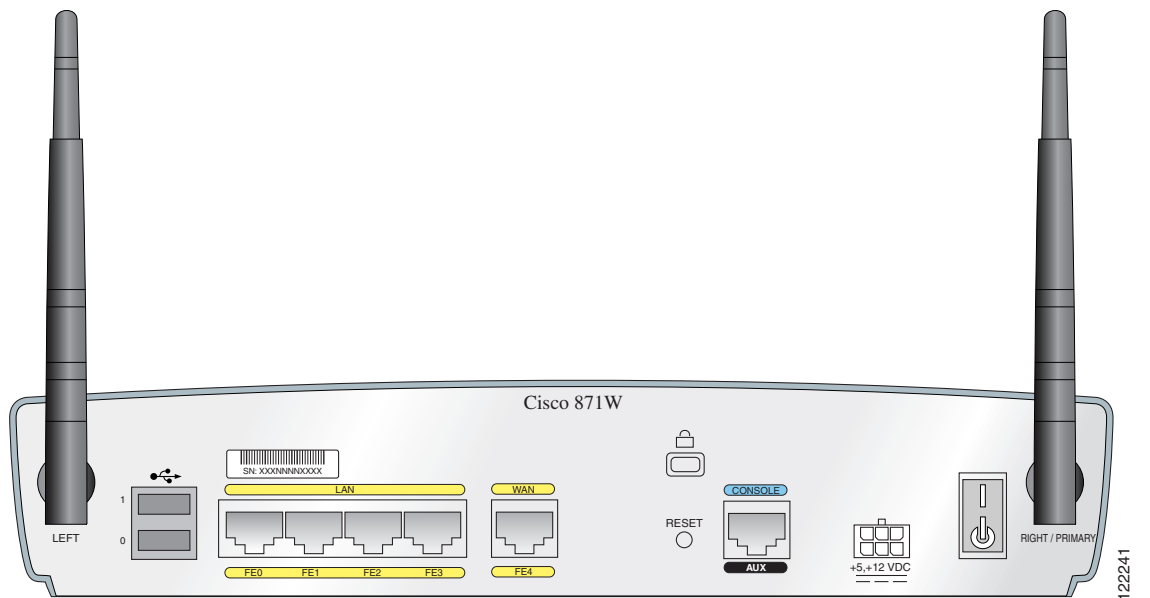

Figure 1-3 Cisco 871 Router Back Panel with Antennas



Router Ports on the Cisco 851 and Cisco 871 Back Panel

The Cisco 851 and Cisco 871 routers have the following ports on the back panel:

- Four 10/100BASE-T RJ-45 Fast Ethernet LAN ports with a built-in switch
- One 10/100BASE-T RJ-45 WAN Fast Ethernet port
- One RJ-45 console port
- Two USB ports (on the Cisco 871 router only)

USB Port Power Allocation on the Cisco 871 Router

The power available for each of the two USB ports is 500 mA. Power is dynamically allocated to each port as needed, up to 500 mA.

Cisco 857 and Cisco 877 ADSL-over-POTS Routers

The Cisco 857 and Cisco 877 routers are asymmetric digital subscriber line (ADSL)-over-plain old telephone service (POTS) routing devices. The routers have an integrated 4-port Ethernet switch for the LAN and an ADSL physical interface for the WAN, allowing the routers to connect a corporate telecommuter or small office to corporate LANs and the Internet.

The front panels of the Cisco 857 and Cisco 877 routers are identical. (See [Figure 1-4](#).) The back panels of these two routers are similar except for their model numbers, which differ. [Figure 1-5](#) shows the back panel of a Cisco 857 router, and [Figure 1-6](#) shows the back panel of a Cisco 877 router.

Figure 1-4 Cisco 857 and Cisco 877 Router Front Panel

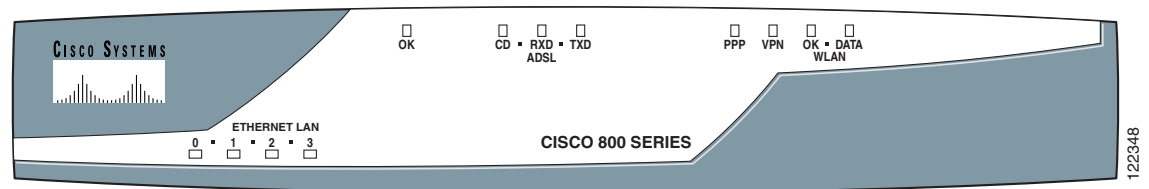

Figure 1-5 Cisco 857 Router Back Panel, with Antenna Installed

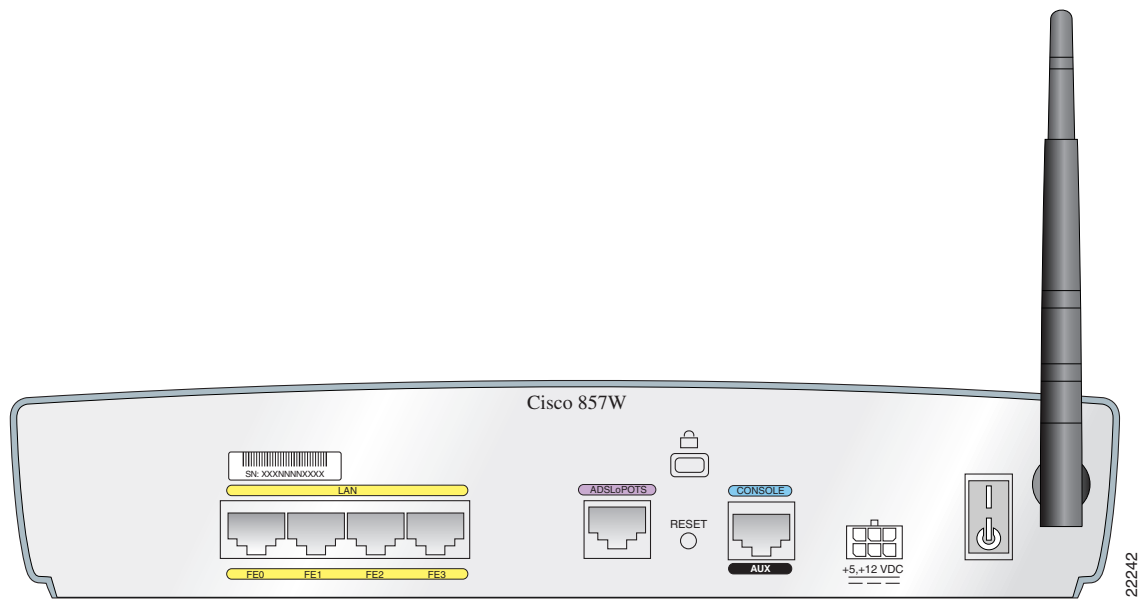
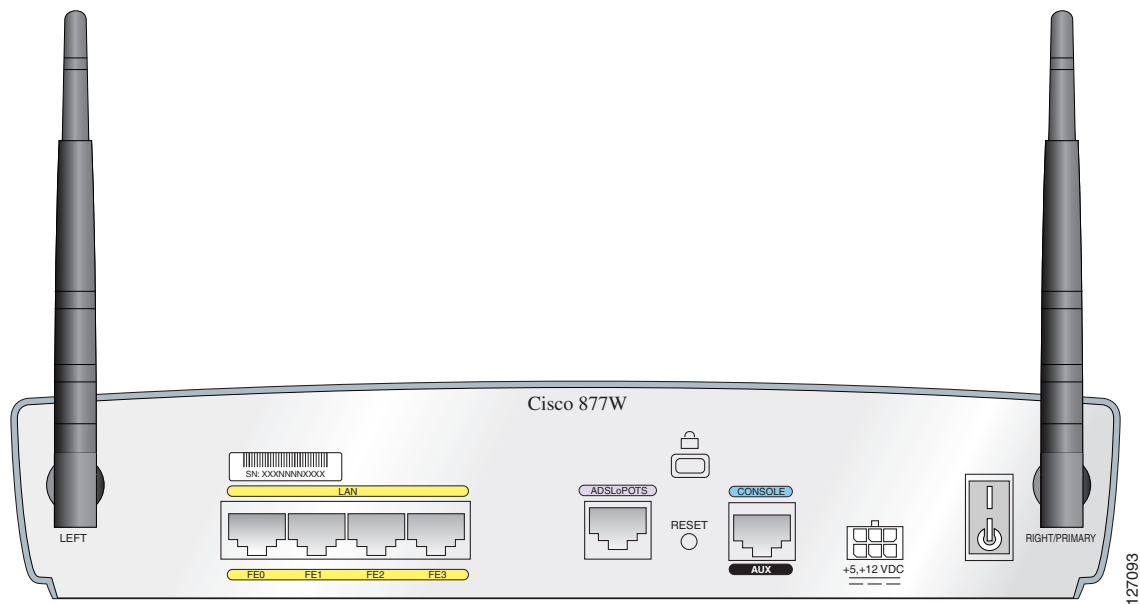

Figure 1-6 Cisco 877 Router Back Panel, with Antennas Installed



Router Ports on the Cisco 857 and Cisco 877 Back Panel

The Cisco 857 and Cisco 877 routers have the following ports on the back panel:

- Four 10/100BASE-T RJ-45 Fast Ethernet LAN ports with a built-in switch
- One ADSL-over-POTS port
- One RJ-45 console port

Cisco 876 ADSL-over-ISDN Router

The Cisco 876 router is an asymmetric digital subscriber line (ADSL)–over–ISDN routing device. The router has an integrated 4-port Ethernet switch for the LAN and an ADSL physical interface for the WAN, and ISDN BRI WAN connectivity. This ISDN BRI interface can be used for normal WAN connections or can be configured as a backup connection for the ADSL WAN interface. These features allow the routers to connect a corporate telecommuter or a small office to a central office or an Internet service provider (ISP) over an ADSL interface.

Figure 1-7 shows the front panel of the Cisco 876 router, and Figure 1-8 shows the back panel.

Figure 1-7 Cisco 876 Router Front Panel

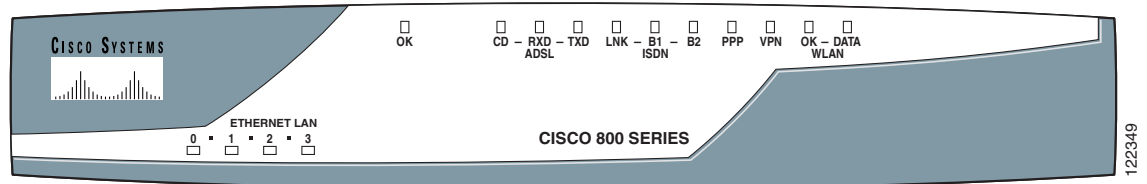
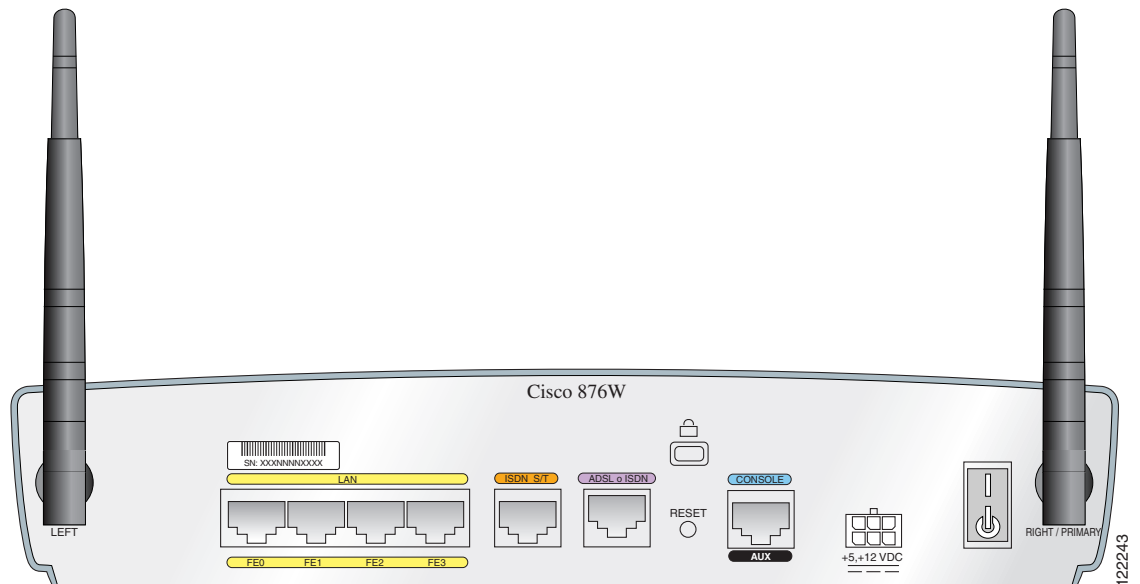

Figure 1-8 Cisco 876 Router Back Panel, with Antennas Installed



Router Ports on the Cisco 876 Back Panel

The Cisco 876 router has the following ports on the back panel:

- Four 10/100BASE-T RJ-45 Fast Ethernet LAN ports with a built-in switch
- One 10/100BASE-T RJ-45 WAN Fast Ethernet port
- One ISDN S/T port
- One ADSL-over-ISDN port
- One RJ-45 console port

Cisco 878 SHDSL Router

The Cisco 878 router can connect a corporate telecommuter or small office to an Internet service provider (ISP) over multirate symmetrical high-data-rate digital subscriber lines (G.SHDSLs) to a corporate LAN and to the Internet.

The router has an integrated 4-port Ethernet switch for the LAN, a G.SHDSL physical interface for the WAN, and an ISDN BRI interface. The ISDN BRI S/T port can be used for remote management. The router is capable of bridging and multiprotocol routing between LAN and WAN ports.

Figure 1-9 shows the front panel of the Cisco 878 router, and Figure 1-10 shows the back panel.

Figure 1-9 Cisco 878 Router Front Panel

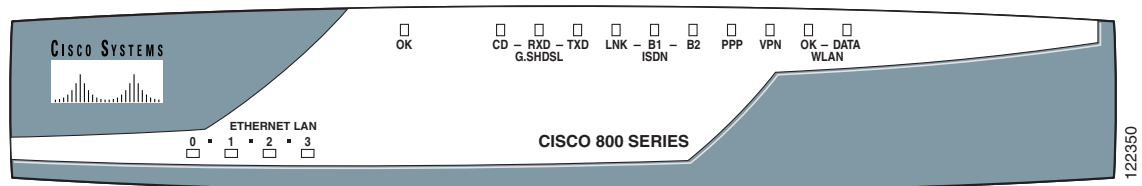
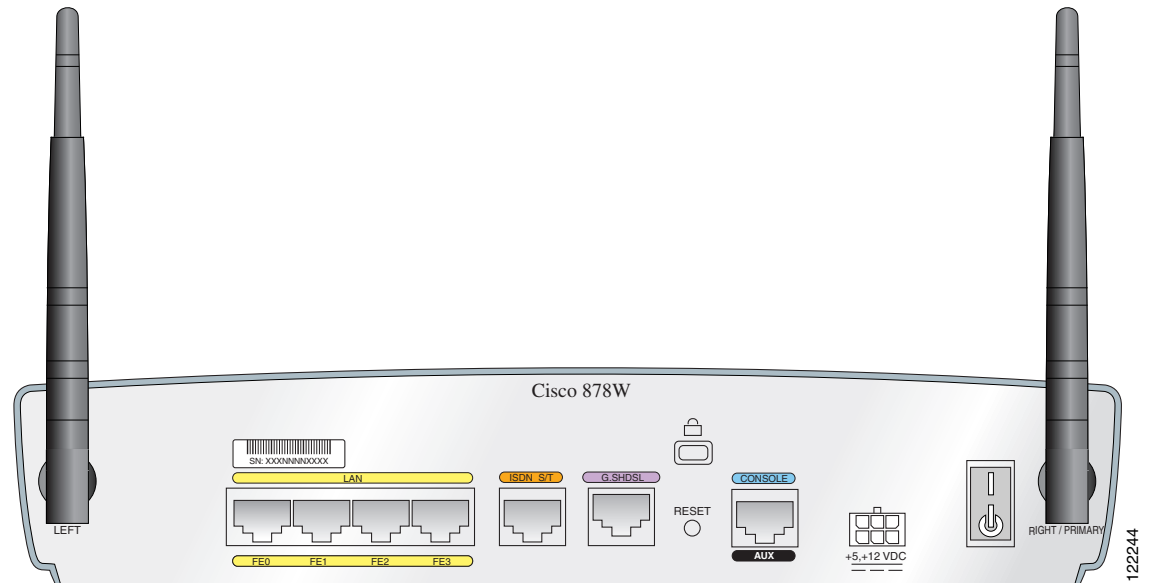

Figure 1-10 Cisco 878 Router Back Panel with Antennas



Router Ports on the Cisco 878 Back Panel

The Cisco 878 router has the following ports on the back panel:

- Four 10/100BASE-T RJ-45 Fast Ethernet LAN ports with a built-in switch
- One ISDN S/T port
- One G.SHDSL port
- One RJ-45 console port

Feature Summary

Table 1-1 summarizes the features of these routers.

Table 1-1 Hardware Feature Summary

Feature	Description
10BASE-T/100BASE-T built-in switch ports	Provides connection to 10/100BASE-T (10/100-Mbps) Ethernet networks. Compatible with 10/100-Mbps devices.
Fast Ethernet WAN port	Cisco 851 and Cisco 871 routers only. Provides connection to 10/100BASE-T. Can be connected to other network devices, such as cable modem, ADSL, and router.
ADSL-over-POTS port	Cisco 857 and Cisco 877 routers only. Provides connection to an ADSL network. Does not support the autoswitch function.
ISDN S/T port	Cisco 876 and Cisco 878 routers only. Provides remote management functions when the main ADSL or SHDSL link goes down by connecting to the ISDN service provider. Can be used for dial backup on Cisco 876 routers only.

Table 1-1 Hardware Feature Summary (continued)

Feature	Description
ADSL-over-ISDN port	Cisco 876 router only. Provides connection to an ADSL-over-ISDN network. Does not support the autoswitch function.
G.SHDSL port	Cisco 878 router only. Provides 2-wire or 4-wire connection to a G.SHDSL network.
Console port	Provides a connection to the terminal or PC for software configuration or troubleshooting using the command-line interface (CLI). The console port may be configured as a virtual auxiliary port (using the CLI) for dial backup and remote management.
Flash memory	Cisco 850 series routers: 20 MB of flash memory (default and maximum) Cisco 870 series routers: 20 MB of flash memory (default) 28 MB of flash memory for routers ordered with a Cisco IOS Advanced IP Services image or Enterprise Services image. Expandable by 8, 16, or 32 MB, up to a maximum of 52 MB.
Synchronous dynamic RAM (SDRAM)	Cisco 850 series routers: 64 MB of SDRAM on board. Cisco 870 series routers: 128 MB of SDRAM on board. Expandable by 64 or 128 MB, up to a maximum of 256 MB.
Router Reset button	Resets the router configuration to the factory default.
Dying gasp	Detects whether the router is about to lose power, and sends a signal to warn the digital subscriber line access multiplexer (DSLAM) about the impending line drop.
Wall-mount feature	Brackets for mounting the router on a wall or vertical surface.
USB ports	Cisco 871 router only. Supports USB-compatible devices such as security tokens and flash memory sticks.
IPSec hardware accelerator	The security processor implements symmetric key encryption, public key encryption, authentication, and data compression in hardware.
Integrated 802.11b/g radio module	(Optional) Provides connectivity to a wireless LAN using IEEE 802.11b/g standards. Enables the router to act as an access point (AP) in infrastructure mode.
External power-over-Ethernet (PoE) module	(Optional) Provides inline power for powered devices (such as PCs and phones) that are connected to the router.
Kensington security slot	Allows the router to be secured to a desktop or other surface by using Kensington lockdown equipment.
Security features	Provides support for virtual private networks (VPNs), Cisco IOS Firewall, and IPSec. For information about software security features, see the <i>Cisco 850 Series and Cisco 870 Series Access Routers Software Configuration Guide</i> .
Autosensing function	Eliminates the need for a crossover cable and allows the router to detect medium-dependent interface in normal mode (MDI) or medium-dependent interface in crossover mode (MDIX) in any other PC or hub with a straight-through cable or a crossover cable. The router is capable of bridging and multiprotocol routing between the LAN and WAN ports.

Hardware Features

This section provides an overview of the hardware features of Cisco 850 series and Cisco 870 series routers and includes the following topics:

- [Serial Number Location](#)
- [LED Indicators on the Routers](#)
- [Integrated 802.11b/g Radio Module \(Wireless Models Only\)](#)
- [Supported Cisco Radio Antennas \(Wireless Models Only\)](#)
- [External Power-over-Ethernet Module \(Optional\)](#)
- [Router Memory](#)
- [Router Hardware Security](#)

Serial Number Location

The serial number label for the router is located on the rear of the chassis, at the left edge (see [Figure 1-11](#)).

Figure 1-11 Serial Number Location

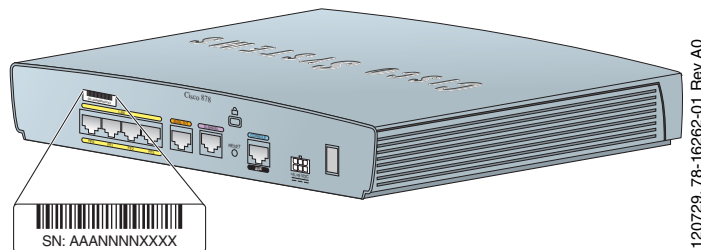

LED Indicators on the Routers

The router LEDs that indicate status or activity on the router are located on the front panel of the routers. [Table 1-2](#) lists and describes the LEDs.

Table 1-2 LED Indicators on the Routers

LED	Color	Description	Router Model
OK	Green	On when DC power is being supplied to the router. The light blinks if an error occurs during bootup.	All Cisco 850 series and Cisco 870 series
WAN LNK	Green	On if the WAN Ethernet carrier detects status and connects to the digital subscriber line access multiplexer (DSLAM).	Cisco 851, Cisco 871
WAN RXD	Green	Blinks when WAN DSL or WAN Internet receives data.	Cisco 851, Cisco 871

Table 1-2 LED Indicators on the Routers (continued)

LED	Color	Description	Router Model
WAN TXD	Green	Blinks when WAN DSL or WAN Internet transmits data. Off when no data is being uploaded.	Cisco 851, Cisco 871
ADSL CD	Green	On if the ADSL carrier detects status and connects to the DSLAM.	Cisco 857, Cisco 876, Cisco 877
ADSL RXD	Green	Blinks when the ADSL interface receives data. Off when there is no data.	Cisco 857, Cisco 876, Cisco 877
ADSL TXD	Green	Blinks when the ADSL interface transmits data. Off when no data is being uploaded.	Cisco 857, Cisco 876, Cisco 877
G.SHDSL CD	Green	On if the SHDSL carrier detects status and connects to the DSLAM.	Cisco 878
G.SHDSL RXD	Green	Blinks when the SHDSL interface receives data. Off when there is no data.	Cisco 878
G.SHDSL TXD	Green	Blinks when the SHDSL interface transmits data. Off when no data is being uploaded.	Cisco 878
ISDN LNK	Green	On when the ISDN D channel connects.	Cisco 876, Cisco 878
ISDN B1	Green	On when the ISDN B1 channel connects. Blinks when the B1 channel receives or sends data, or when data passes through ISDN channel 1.	Cisco 876, Cisco 878
ISDN B2	Green	On when the ISDN B2 channel connects. Blinks when the B2 channel receives or sends data, or when data passes through ISDN channel 2.	Cisco 876, Cisco 878
PPP	Green	PPP-over-Ethernet (PPPoE) or PPP-over-ATM (PPPoA) client status. On if at least one PPPoE or PPPoA client session is running. Off if neither PPPoE nor PPPoA is running.	All Cisco 850 series and Cisco 870 series
VPN	Green	VPN tunnel status. On when at least one crypto (IPSec) session is running. Off when no crypto session is running.	All Cisco 850 series and Cisco 870 series
WLAN OK	Green	Shows whether the wireless link status is operational. Blinks if no client is associated. Solid green if at least one client is associated.	All Cisco 850 series and Cisco 870 series wireless models
WLAN DATA	Green	Wireless LAN link traffic. Blinks if there is traffic on the wireless LAN. Off if there is no traffic.	All Cisco 850 series and Cisco 870 series wireless models

Table 1-2 LED Indicators on the Routers (continued)

LED	Color	Description	Router Model
ETHERNET LAN 0	Green	On when a device connects to the Ethernet LAN 0 port. Blinks when the Ethernet LAN 0 port receives or sends data, or when data passes through the port.	All Cisco 850 series and Cisco 870 series
ETHERNET LAN 1	Green	On when a device connects to the Ethernet LAN 1 port. Blinks when the Ethernet LAN 1 port receives or sends data, or when data passes through the port.	All Cisco 850 series and Cisco 870 series
ETHERNET LAN 2	Green	On when a device connects to the Ethernet LAN 2 port. Blinks when the Ethernet LAN 2 port receives or sends data, or when data passes through the port.	All Cisco 850 series and Cisco 870 series
ETHERNET LAN 3	Green	On when a device connects to the Ethernet LAN 3 port. Blinks when the Ethernet LAN 3 port receives or sends data, or when data passes through the port.	All Cisco 850 series and Cisco 870 series

Integrated 802.11b/g Radio Module (Wireless Models Only)

The Cisco 850 series and Cisco 870 series wireless routers have an integrated IEEE 802.11b/g radio module that operates as a wireless access point in infrastructure mode. The wireless routers have two reverse-polarity threaded Neill-Concelman (RP-TNC) connectors on the back panel. The dipole swivel antennas that were shipped with the router connect to the RP-TNC connectors to operate the 802.11b/g radio module.

The wireless operations can be configured by using the Cisco Router and Security Device Manager (SDM) web-based application, or by using the Cisco IOS command-line interface (CLI). See the *Cisco Router and Security Device Manager (SDM) Quick Start Guide* or the *Cisco Access Router Wireless Configuration Guide* for more information.

Supported Cisco Radio Antennas (Wireless Models Only)

Table 1-3 lists the Cisco antennas that are supported on the Cisco 850 series and Cisco 870 series wireless routers.

Table 1-3 Cisco Antennas Supported on the Cisco 850 Series and Cisco 870 Series Wireless Routers

Cisco Part Number	Antenna Type	Maximum Gain	Description
23.7786.51	Omnidirectional	2.2 dBi	This is the default antenna. Swivel-mount dipole antenna operating in the 2.4- to 2.5-GHz band. This antenna is designed for use with Cisco wireless products utilizing an RP-TNC connector. For more information, see the Cisco 2.4-GHz Swivel-Mount Dipole Antenna (23.7786.51) document.
AIR-ANT4941	Omnidirectional	2.2 dBi	Swivel-mount dipole antenna operating in the 2.4- to 2.5-GHz band. This antenna is designed for use with Cisco wireless products utilizing an RP-TNC connector. For more information, see the Cisco Aironet 2.4 Ghz Articulated Dipole Antenna (AIR-ANT4941) document.
AIR-ANT1728	Omnidirectional	5.2 dBi	Ceiling-mount antenna operating in the 2.4- to 2.5-GHz band. This antenna has a clip that allows it to be mounted to a drop-ceiling cross member. For more information, see the Cisco Aironet High Gain Omnidirectional Ceiling Mount Antenna (AIR-ANT1728) document. Note This antenna is not supported in Japan.
AIR-ANT3549	Patch	9 dBi	Wall-mount antenna operating in the 2.4- to 2.5-GHz band. Note This antenna is not supported in the United States and Canada.
AIR-ANT5959	Diversity omnidirectional	2.35 dBi	Ceiling-mount antenna operating in the 2.4- to 2.5-GHz band. This antenna has a clip that allows it to be mounted to a drop-ceiling cross member. For more information, see the Cisco Aironet 2 dBi Diversity Omnidirectional Ceiling Mount Antenna (AIR-ANT5959) document.

External Power-over-Ethernet Module (Optional)

The optional external power-over-Ethernet (PoE) module is a standalone device that connects to the Ethernet ports on the router on one side (To ROUTER) and to powered devices (such as PCs, laptops, and IP phones) on the other side (To LAN). The PoE module has an independent power source that can provide inline power to devices connected to each of the four Ethernet ports, so that these devices do not need separate power sources.

Caution

To ensure proper PoE module operation, do not connect the PoE module power supply to the PoE module before you connect the PoE module to the router. Do not connect ISDN devices to the Ethernet ports on the PoE module; doing so may damage the hardware.

Figure 1-12 Power-over-Ethernet Module Front Panel

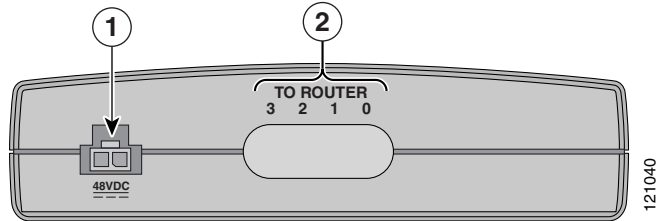

<p>1 Power adapter input jack</p>	<p>2 Cable numbers associated with the corresponding Ethernet ports on the back panel. The integrated cable below the cable number label, consisting of four RJ-45 connectors organized by a plastic clip, is not shown in this illustration.</p>
--	--

Figure 1-13 Power-over-Ethernet Module Back Panel

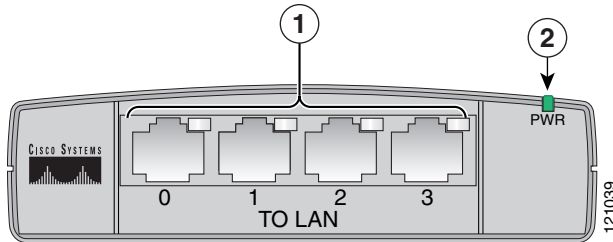

<p>1 LED indicators and Ethernet ports for connecting powered devices</p>	<p>2 Power indicator</p>
--	---------------------------------

Figure 1-14 Installing the PoE Module

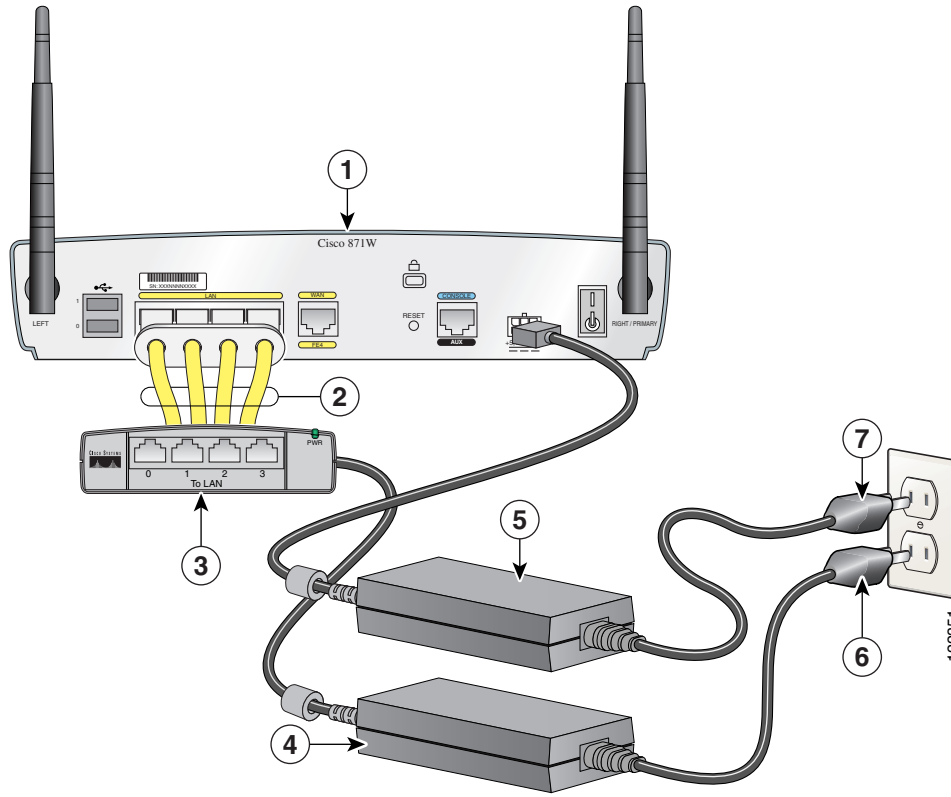

1	Cisco 870 series router	5	Router power adapter
2	Ethernet cables on the PoE module (four RJ-45 connectors in series)	6	PoE power plug
3	PoE module	7	Router power plug
4	PoE power adapter		

Figure 1-15 Connecting the PoE Module to the Router

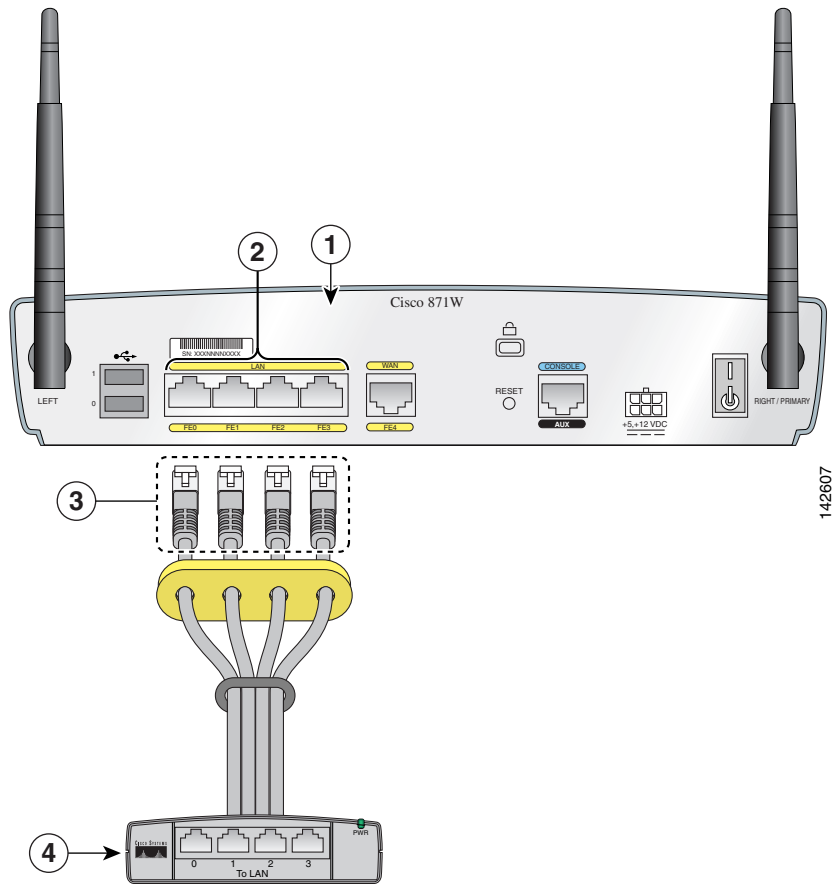

1	Cisco 870 series router	3	Four RJ-45 Ethernet plugs, in series, from the PoE module (plug these into the Ethernet ports on the router)
2	RJ-45 Ethernet ports on the router	4	PoE module

Figure 1-16 PoE Module Connected to the Router

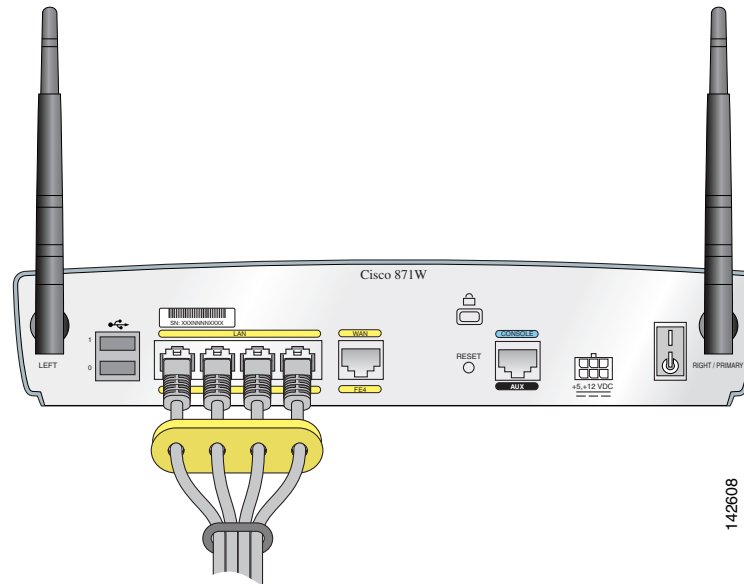

LED Indicators on the PoE Module

Table 1-4 LED Indicators for the PoE Module

LED	Color and Behavior	Description
POE ports 0, 1, 2, 3	None	No powered device detected
	Solid amber	Power administratively down
	Solid green	Power provided to the device
	Blinking amber	Fault detected in power delivery
	Blinking green	Power denied to the device

Router Memory

Cisco 850 series and Cisco 870 series routers support the following types of memory:

- [Flash Memory](#)
- [SDRAM](#)

Flash Memory

Flash memory stores the image of the ROMMON boot code, the Cisco IOS software, and the router configuration file. The router provides two onboard StrataFlash devices, one with 16 MB and the other with 4 MB of memory, for a total of 20 MB of onboard flash memory.

- For Cisco 850 series routers, the default and maximum flash memory is 20 MB. This is not upgradable.
- For Cisco 870 series routers, an expansion slot allows for an additional 8 MB, 16 MB, or 32 MB of memory. The maximum flash memory is 52 MB. The default flash memory depends on which Cisco IOS image is ordered with the router.
 - By default, the router ships with 4 MB in the expansion slot, for a total of 24 MB of flash memory.
 - If ordered with a Cisco IOS Advanced IP Services image or Enterprise Services image, the router ships by default with 8 MB of memory in the expansion slot, for a total of 28 MB of flash memory.

SDRAM

SDRAM stores the Cisco IOS software and provides memory for data created during packet processing. The router provides 128 MB of onboard SDRAM, with an expansion slot that allows an additional 64 MB or 128 MB, up to a maximum of 256 MB of SDRAM.

Router Hardware Security

The Cisco 850 series and Cisco 870 series routers have a Kensington security slot on the back panel. To secure the router to a desktop or other surface, use the Kensington lockdown equipment.

Regulatory Compliance

For compliance and safety information, see the *Regulatory Compliance and Safety Information for Cisco 800 Series and SOHO Series Routers* document that was shipped with the router.

For wireless models, also see the *Declarations of Conformity and Regulatory Information for Cisco Access Products with 802.11a/b/g and 802.11b/g Radios* document that was shipped with the router.



Preinstallation Information

This chapter provides information about safety, unpacking the router, and preparing for installation for Cisco 851, Cisco 857, Cisco 871, Cisco 876, Cisco 877, and Cisco 878 routers. It contains the following sections:

- [Safety Warnings and Guidelines, page 2-1](#)
- [Preventing Damage to the Router, page 2-4](#)
- [Unpacking the Box, page 2-4](#)
- [Preparing for Installation, page 2-5](#)
- [What to Do Next, page 2-6](#)

Safety Warnings and Guidelines

This section provides the safety warnings and guidelines for working with wireless and nonwireless routers that are applicable to the Cisco 850 series and Cisco 870 series routers.

Before installing the router and the optional Power-over-Ethernet (PoE) module, read the following warnings:

Warning

Read the installation instructions before connecting the system to the power source. Statement 1004

Warning

Voltages that present a shock hazard may exist on Power over Ethernet (PoE) circuits if interconnections are made using uninsulated exposed metal contacts, conductors, or terminals. Avoid using such interconnection methods, unless the exposed metal parts are located within a restricted access location and users and service people who are authorized within the restricted access location are made aware of the hazard. A restricted access area can be accessed only through the use of a special tool, lock and key or other means of security. Statement 1072

Warning

No user-serviceable parts inside. Do not open. Statement 1073

Warning

Installation of the equipment must comply with local and national electrical codes. Statement 1074

**Warning**

This product relies on the building's installation for short-circuit (overcurrent) protection. Ensure that the protective device is rated not greater than: 120 VAC, 15A U.S. (240 VAC, 10A international)

Statement 1005

**Warning**

To avoid electric shock, do not connect safety extra-low voltage (SELV) circuits to telephone-network voltage (TNV) circuits. LAN ports contain SELV circuits, and WAN ports contain TNV circuits. Some LAN and WAN ports both use RJ-45 connectors. Use caution when connecting cables. Statement 1021

**Warning**

Do not work on the system or connect or disconnect cables during periods of lightning activity.

Statement 1001

**Warning**

Ultimate disposal of this product should be handled according to all national laws and regulations.

Statement 1040

**Warning**

To reduce the risk of fire, use only No. 26 AWG or larger telecommunication line cord. Statement 1023

**Warning**

Before working on a chassis or working near power supplies, unplug the power cord on AC units; disconnect the power at the circuit breaker on DC units. Statement 12

**Warning**

During this procedure, wear grounding wrist straps to avoid ESD damage to the card. Do not directly touch the backplane with your hand or any metal tool, or you could shock yourself. Statement 94

**Warning**

Before working on equipment that is connected to power lines, remove jewelry (including rings, necklaces, and watches). Metal objects will heat up when connected to power and ground and can cause serious burns or weld the metal object to the terminals. Statement 43

**Warning**

This equipment is not designed for making emergency telephony calls when the power fails. Alternative arrangements should be made for access to emergency services. Access to emergency services can be affected by any call-barring function of this equipment. Statement 199

**Caution**

Inline power circuits provide current through the communication cable. Use the cable provided by Cisco or a communication cable with a minimum of 24 AWG.

Additional Warnings for Wireless Routers



Warning

In order to comply with FCC radio frequency (RF) exposure limits, antennas should be located at a minimum of 7.9 inches (20 cm) or more from the body of all persons. Statement 332



Warning

Do not operate your wireless network device near unshielded blasting caps or in an explosive environment unless the device has been modified to be especially qualified for such use.

Statement 245B

General Safety Guidelines for Wireless Routers

The following are guidelines for the wireless router models:

- Do not touch or move antenna(s) while the unit is transmitting or receiving.
- Do not hold any component containing a radio so that the antenna is very close to or touching any exposed parts of the body, especially the face or eyes, while transmitting.
- The use of wireless devices in hazardous locations is limited to the constraints posed by the local codes, the national codes, and the safety directors of such environments.

Preventing Electrostatic Discharge Damage

Electrostatic discharge (ESD) is a transfer of electrostatic charge between bodies of different electrostatic potentials, such as an operator and a piece of electrical equipment. It occurs when electronic components are improperly handled, and it can damage equipment and impair electrical circuitry. Electrostatic discharge is more likely to occur in the presence of synthetic fibers and dry atmosphere.

Always use the following ESD-prevention procedures when removing and replacing components:

Step 1 Wear an ESD-preventive wrist strap that you provide, ensuring that it makes good skin contact.



Caution

To properly guard against ESD damage and shocks, the wrist strap and cord must operate effectively. Always follow the warnings and guidelines in this section.

Step 2 Do not touch any exposed contact pins or connector shells of interface ports that do not have a cable attached.

If cables are connected at one end only, do not touch the exposed pins at the unconnected end of the cable. This device is intended for use in residential and commercial environments only.



Caution

Periodically check the resistance value of the antistatic strap, which should be between 1 and 10 megohms (Mohm).

Preventing Damage to the Router

Follow these guidelines when connecting devices to your router:

- Connect the color-coded cables supplied by Cisco Systems to the color-coded ports on the back panel.
- If you must supply your own cable, see [Appendix A, “Specifications,”](#) for cabling specifications. If this appendix does not provide specifications for a particular cable, we strongly recommend ordering the cable from Cisco Systems.

Unpacking the Box

[Table 2-1](#) lists the quantity of items that are shipped with each router model in the Cisco 850 series and the Cisco 870 series routers. [Figure 2-1](#) depicts the items.

Verify that you have received all the items. If any is missing or damaged, contact your customer service representative.

Table 2-1 *Items Shipped with Cisco 850 Series and Cisco 870 Series Routers*

Item	Cisco 851 and Cisco 871 Routers	Cisco 857 and Cisco 877 Routers	Cisco 876 Router	Cisco 878 Router
Ethernet cable(s)	2	1	1	1
DSL ¹ cable	Not applicable	1 ²	1 ³	1 ³
ISDN ⁴ S/T cable	Not applicable	Not applicable	Optional	Optional
Console cable	1	1	1	1
Console-auxiliary ⁵ cable	Optional	Optional	Optional	Optional
Power adapter	1	1	1	1
Power cord ⁶	1	1	1	1
Cisco documentation ⁷	1	1	1	1
Cisco Router and Security Device Manager (SDM) software CD	1	1	1	1
Swivel-mount dipole antenna (wireless router models only)	Cisco 851: 1 antenna Cisco 871: 2 antennas	Cisco 857: 1 antenna Cisco 877: 2 antennas	2	2

1. DSL = digital subscriber line. Used for an asynchronous digital subscriber line (ADSL) or multirate symmetrical high-data-rate digital subscriber line (G.SHDSL).
2. An RJ-11-to-RJ-11 straight-through cable is shipped, unless an RJ-11-to-RJ-11 crossover cable is specified.
3. An RJ-11-to-RJ-11 straight-through cable is shipped, unless an RJ-11-to-RJ-11 crossover cable or an RJ-11-to-RJ-45 cable is specified.
4. ISDN = Integrated Services Digital Network.
5. Console-auxiliary cable is used to connect the router console port to an async modem for dial backup or remote management.
6. Power cords are ordered as applicable to country or geographic region.
7. Includes the *Regulatory Compliance and Safety Information for Cisco 800 Series and SOHO Series Routers* document and the *Cisco 850 Series and Cisco 870 Series Access Routers Cabling and Setup Quick Start Guide*. Also includes the *Declarations of Conformity and Regulatory Information for Cisco Access Products with 802.11a/b/g and 802.11b/g Radios* document for wireless models.

Figure 2-1 *Items Included with the Cisco 850 Series and Cisco 870 Series Routers*

1	Yellow Ethernet cable	5	Black power cord for adapter
2	Lavender DSL cable (optional)	6	Product documentation
3	Light blue console cable	7	Cisco SDM software CD
4	Router power adapter	8	Swivel-mount dipole antenna (wireless router models only)

Preparing for Installation

Before installing the router and connecting devices to the router, perform these tasks:

-
- Step 1** Obtain a broadband or Ethernet connection from your service provider.
 - Step 2** Remove the cables and product documentation from the plastic bag. Remove the router power adapter and the black power cord from the accessory kit.
 - Step 3** If you ordered a wireless router, remove the antennas from the box.
 - Step 4** If you ordered a power-over-Ethernet (PoE) module, remove the PoE, its power adapter, and its power cord from the box.
 - Step 5** Gather the Ethernet devices to be connected to the router: hub, servers, and workstations or PCs. Make sure that there is a network interface card (NIC) in each device for connection to Ethernet ports.
 - Step 6** If you plan to configure the software using Cisco IOS commands using the console port, provide an ASCII terminal or a PC that is running terminal emulation software to connect to the console port.
 - Step 7** If you plan to connect a modem, provide the modem and modem cable.
 - Step 8** If you plan to use the ISDN S/T port, provide an NT1 device and an ISDN S/T cable.

- Step 9** If you plan to use the cable-lock feature, provide a Kensington or equivalent locking cable.
- Step 10** Read the safety warnings (the [“Safety Warnings and Guidelines”](#) section) and information about preventing damage to the router (the [“Preventing Damage to the Router”](#) section).
-

What to Do Next

Mount the router properly by following the instructions in [Chapter 3, “Router and PoE Module Mounting Procedures.”](#)



Router and PoE Module Mounting Procedures

This chapter describes the procedures for mounting the following routers and the power-over-Ethernet (PoE) module:

- Cisco 851 and Cisco 871 routers
- Cisco 857 and Cisco 877 routers
- Cisco 876 router
- Cisco 878 router

This chapter contains the following sections:

- [Connecting Antennas to the Wireless Router, page 3-1](#)
- [Mounting on a Table, page 3-1](#)
- [Mounting on a Wall, page 3-2](#)
- [What to Do Next, page 3-6](#)

Connecting Antennas to the Wireless Router

Before you mount the router on a table or a wall, connect the antennas to the back panel. It is difficult to attach the antennas after the router has been mounted to a wall.

Mounting on a Table

The router and the PoE module can be mounted on a table or other flat horizontal surface.

To mount the router on a table, firmly place the router on a table. Do not cover or obstruct the router vents, which are located on the router sides.

To mount the PoE module on a table, place the PoE module near the router so that the Ethernet cables on the PoE module can easily connect to the router Ethernet ports.



Caution

Do not cover or obstruct the router vents; otherwise, overheating could occur and cause damage to the router.

Mounting on a Wall

This section provides information for mounting the router and the PoE module on a wall.

Guidelines for Wall Mounting

You should meet the following guidelines when you mount the router or PoE module on a wall:

- Mount the router with the front panel facing upward so that the LEDs are clearly visible.
- Mount the router low enough for you to see the LEDs.
- Mount the PoE module with the Ethernet cables (To ROUTER side) facing up, and the ports (To LAN side) facing down.
- The Ethernet cables on the PoE module must easily connect to the Ethernet ports on the router.
- The power supply must rest on a horizontal surface such as the floor or a table. If the power supply is not supported, the strain on the power adapter cable could cause it to disconnect from the connector on the router back panel.
- Do not install the router, PoE module, or power supplies next to a heat source of any kind, including heating vents during winter.

Mounting the Router on a Wall

The router can be mounted on a wall by using the molded mounting brackets on the bottom of the router and three number-six, 3/4-in. (M3.5 x 20 mm) screws. You must provide the screws. [Figure 3-1](#) shows the mounting brackets.

**Caution**

If you are mounting the router on drywall, use three hollow-wall anchors to secure the three 1/8-in. (M3) screws. If the screws are not properly anchored, the strain of the network cable connections could pull the router from the wall. Use the drill bit size that is specified by the hollow-wall anchor manufacturer.

Figure 3-1 Mounting Brackets on the Bottom of the Router

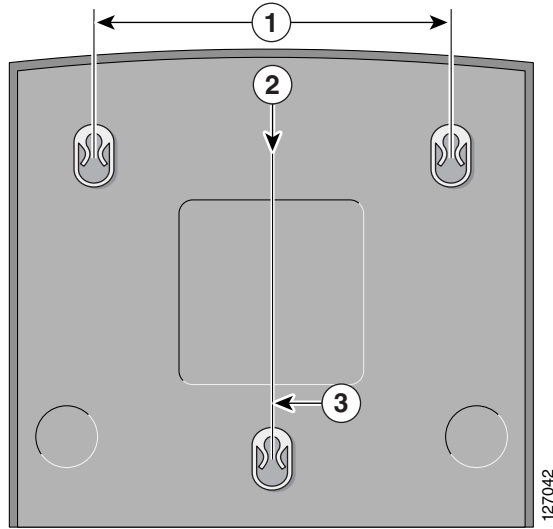

1	Distance between two top mounting brackets (near the front panel)	3	Vertical distance between the top mounting brackets and the bottom bracket
2	Midpoint between the two top mounting brackets (near the front panel)		

Figure 3-2 shows the locations of the mounting screws and the router mounting brackets, and the placement of the power adapter.

Figure 3-2 Mounting the Router on a Wall

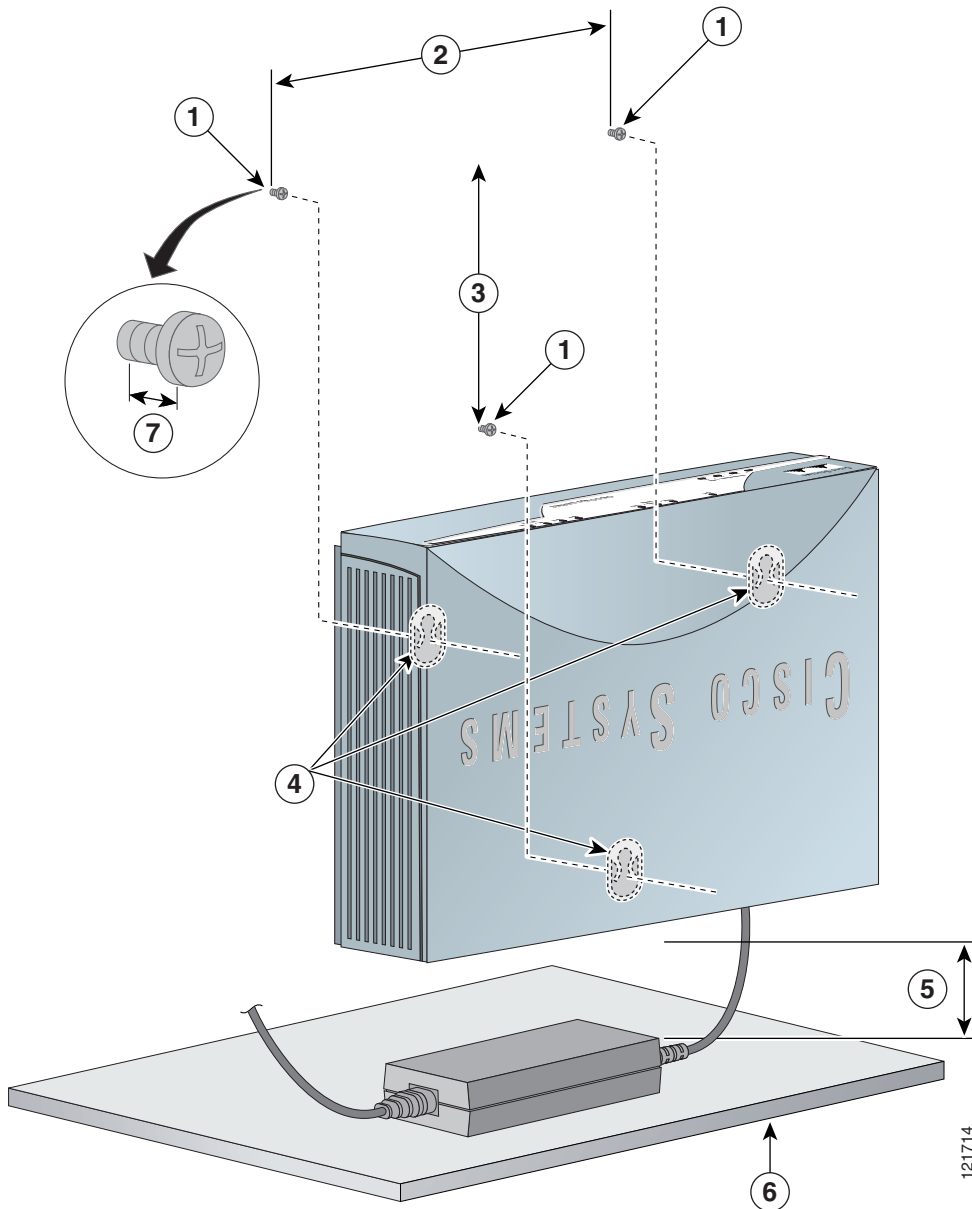

1	Three number-six, 3/4 in. screws	5	Maximum distance between the router and the power adapter (6 ft. [1.8 m])
2	Distance between the top set of screws on the wall	6	Horizontal surface on which to place the power adapter
3	Vertical distance between the top screws and the bottom screw on the wall	7	Distance between the screw head and the wall (1/8 in. [0.32 cm])
4	Mounting brackets		

Perform the following steps to mount the router on a wall:

-
- Step 1** Select a location on the wall on which you wish to mount the router. Using [Figure 3-1](#) as a reference, draw a horizontal line measuring 6.69 in. (17.0 cm) long.
 - Step 2** Make sure that the horizontal line is level. Drill two holes for the mounting screws, one at each end of the line. Use the drill bit size that is specified by the screw or hollow-wall anchor manufacturer.
 - Step 3** Measure 3.345 in. (8.5 cm) from either one of the screw holes to determine the midpoint between the two top mounting screws.
 - Step 4** From the midpoint, measure a vertical distance of 5.55 in. (14.1 cm) to determine the location for the bottom mounting screw, and then drill a hole.
 - Step 5** Anchor the screws into the wall, leaving 1/8 in. (0.32 cm) between the screw head and the wall for mounting the router.
 - Step 6** Hang the router on the screws as shown in [Figure 3-2](#). Secure the screws into the latches of the mounting brackets.
 - Step 7** Place the power adapter on a horizontal surface. (See [Figure 3-2](#).)
-

Mounting the PoE Module on a Wall

The PoE module can be mounted on a wall near the router. [Figure 3-3](#) shows the location of the mounting brackets on the bottom panel of the PoE module.

Figure 3-3 Mounting Brackets on the Bottom Panel of the PoE Module

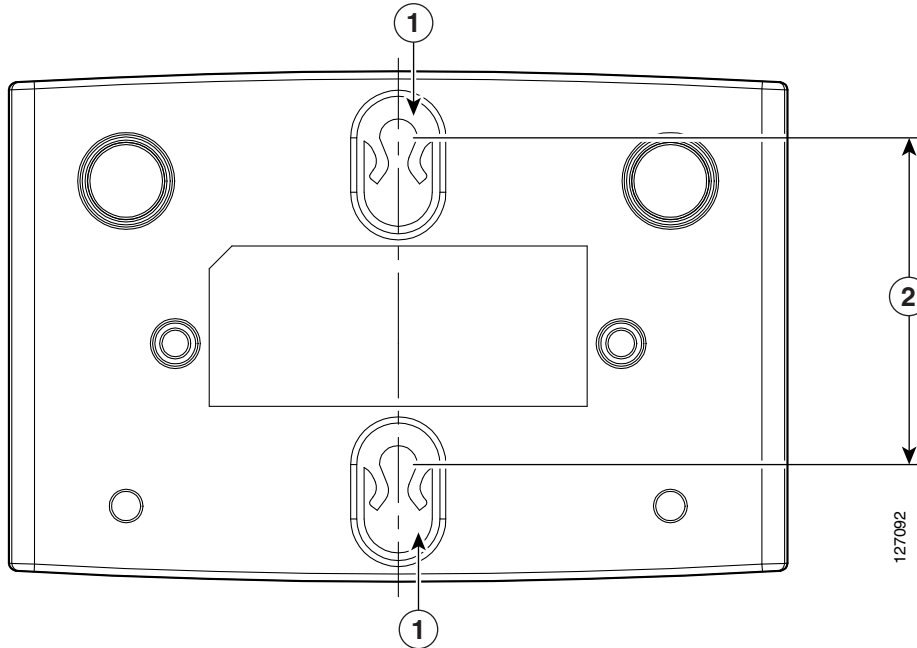

1	Mounting brackets	2	Distance between the mounting brackets (1.70 in. [4.32 cm])
----------	-------------------	----------	--

Perform the following steps to mount the PoE module on a wall:

-
- Step 1** Select a location on the wall on which you wish to mount the PoE module. See [Figure 3-3](#) for the locations of the mounting brackets on the bottom panel.
 - Step 2** Mark on the wall where the mounting screws will be anchored, making sure that the marks line up vertically. Drill two holes 1.70 in. (4.32 cm) apart on the wall, using the drill bit size that is specified by the screw or hollow-wall anchor manufacturer.
 - Step 3** Anchor the screws into the wall, leaving 1/8 in. (0.32 cm) between the screw head and the wall for mounting the PoE module.
 - Step 4** Hang the PoE module on the wall, and secure the screws into the latches of the mounting brackets.
 - Step 5** Place the power supply on a horizontal surface.
-

What to Do Next

Connect devices to the router by following the instructions in [Chapter 4, “Router Cabling Procedures.”](#)



Router Cabling Procedures

This chapter describes the cabling procedures for Cisco 851, Cisco 857, Cisco 871, Cisco 876, Cisco 877, and Cisco 878 routers. It contains the following sections:

- [Cabling for Nonwireless Routers](#), page 4-2
- [Typical Installations](#), page 4-2
- [Connecting the Radio Antennas to the Wireless Router](#), page 4-6
- [Connecting the Power-over-Ethernet Module \(Optional\)](#), page 4-7
- [Connecting a Server, PC, or Workstation](#), page 4-8
- [Connecting an External Ethernet Switch \(Optional\)](#), page 4-9
- [Connecting a Broadband Modem](#), page 4-11
- [Connecting a Terminal or PC to the Console Port](#), page 4-12
- [Connecting an Async Modem to the Console Port](#), page 4-13
- [Connecting an ISDN S/T Port](#), page 4-14
- [Connecting an ADSL Line—ADSLoPOTS Port](#), page 4-16
- [Connecting an ADSL Line—ADSLoISDN Port](#), page 4-17
- [Connecting a G.SHDSL Line](#), page 4-18
- [Connecting the AC Adapter](#), page 4-19
- [Verifying Router Operations](#), page 4-21
- [What to Do Next](#), page 4-22



Note

Read [Chapter 2, “Preinstallation Information,”](#) before you start the cabling procedures, making sure to follow the safety warnings and guidelines in the [“Safety Warnings and Guidelines”](#) section.



Note

The router and the optional power-over-Ethernet (PoE) module should be mounted before being connected to the devices. See [Chapter 3, “Router and PoE Module Mounting Procedures.”](#)

Cabling for Nonwireless Routers

Some portions of this document do not apply to nonwireless router models. Although illustrations show the router with antennas attached, the nonwireless routers do not have antennas or connectors on the back panel. However, except for the “[Connecting the Radio Antennas to the Wireless Router](#)” section, the procedures for connecting devices to the router are the same for wireless and nonwireless routers.

Typical Installations

Typical installations of the Cisco 850 series and Cisco 870 series routers are depicted in [Figure 4-1](#) through [Figure 4-4](#), as follows:

- Cisco 851 and Cisco 871 router—See [Figure 4-1](#).
- Cisco 857 and Cisco 87 router—See [Figure 4-2](#).
- Cisco 876 router—See [Figure 4-3](#).
- Cisco 878 router—See [Figure 4-4](#).

[Figure 4-1](#) shows a typical installation of a Cisco 851 or Cisco 871 router. This figure shows the back panel of a Cisco 871 router, which has two USB ports. The Cisco 851 router does not have any USB ports; however, the connections on the other ports are the same for both the Cisco 851 and Cisco 871 routers.

Figure 4-1 Typical Installation of a Cisco 851 or Cisco 871 Router

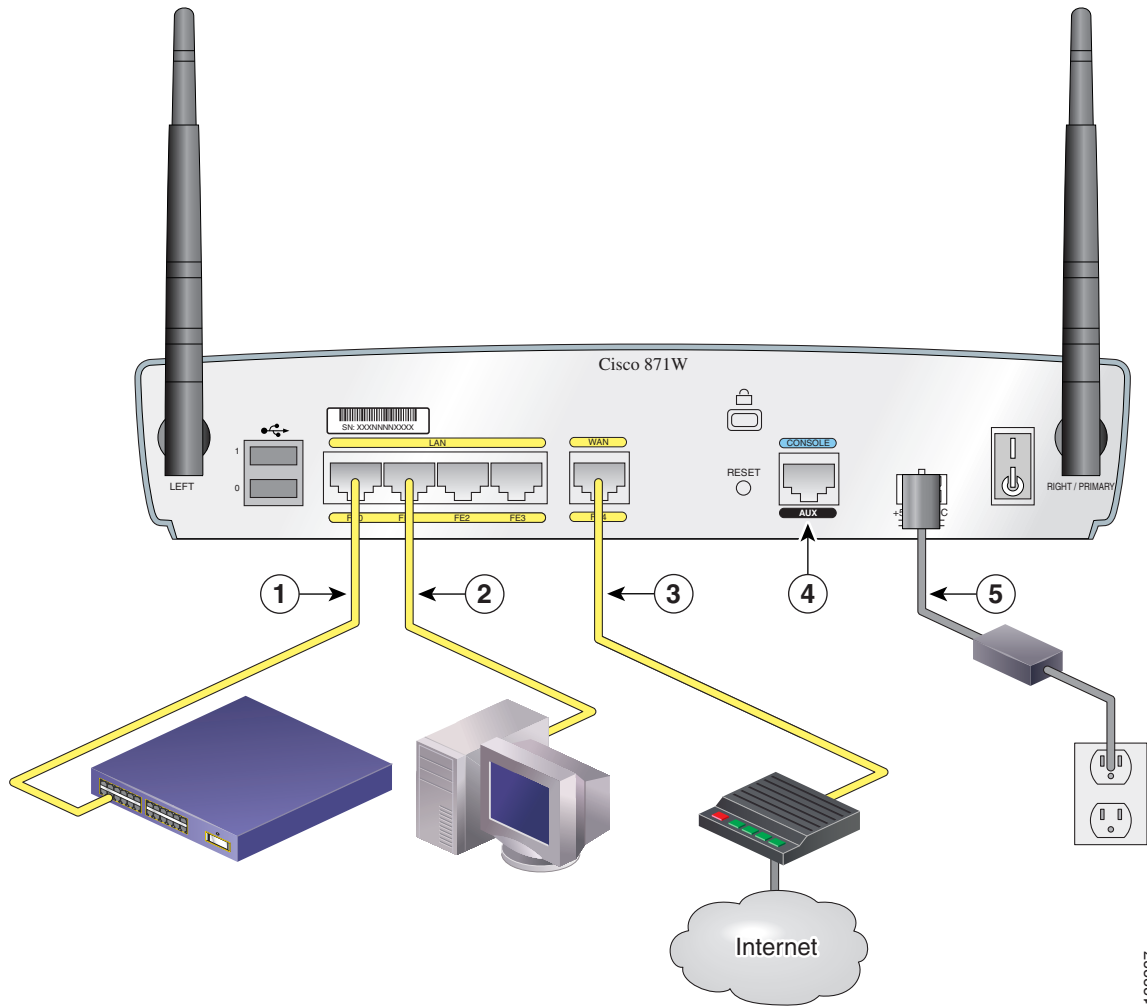

122237

1	Ethernet connection to an external switch	4	Console port
2	Ethernet connection to a PC	5	Power adapter
3	WAN connection using a broadband modem to the Internet		

Figure 4-2 Typical Installation of a Cisco 857 or Cisco 877 Router

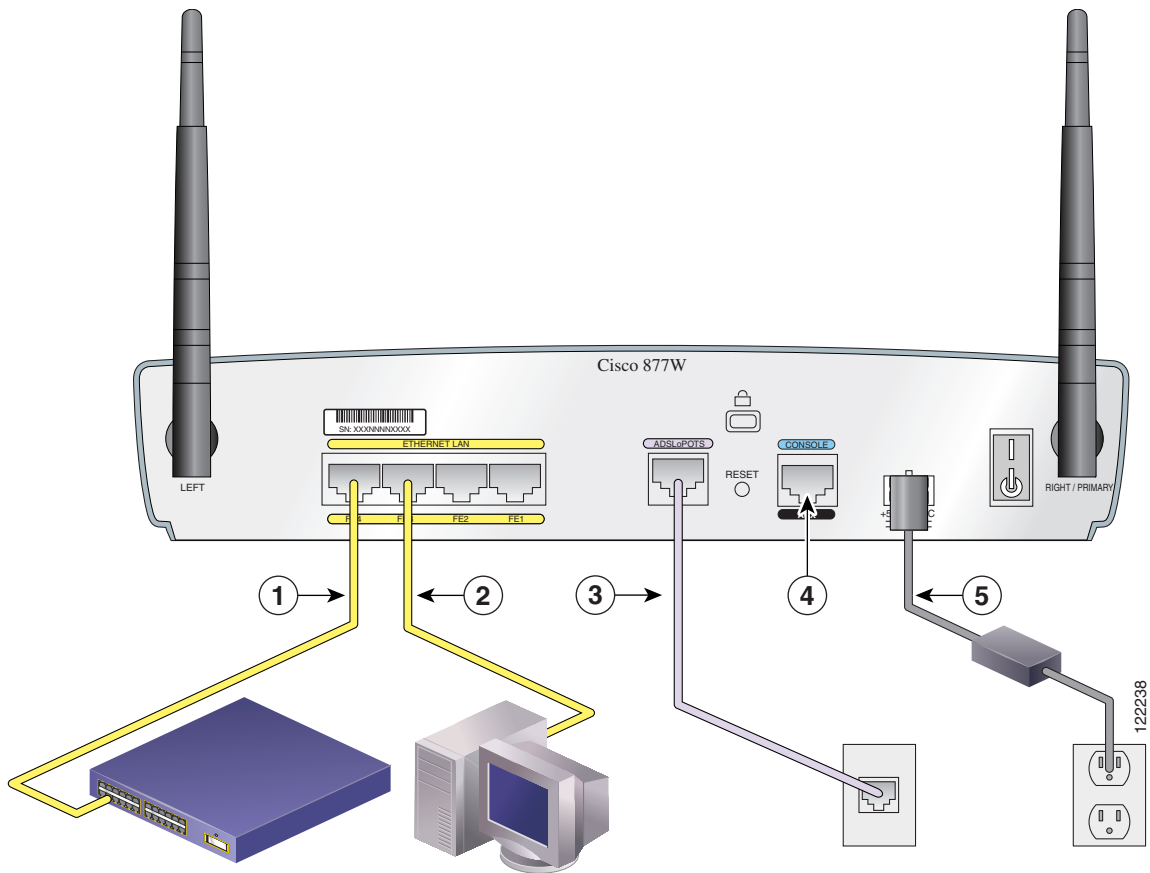

1	Ethernet connection to an external switch	4	Console port
2	Ethernet connection to a PC	5	Power adapter
3	ADSL-over-POTS connection		

Figure 4-3 Typical Installation of a Cisco 876 Router

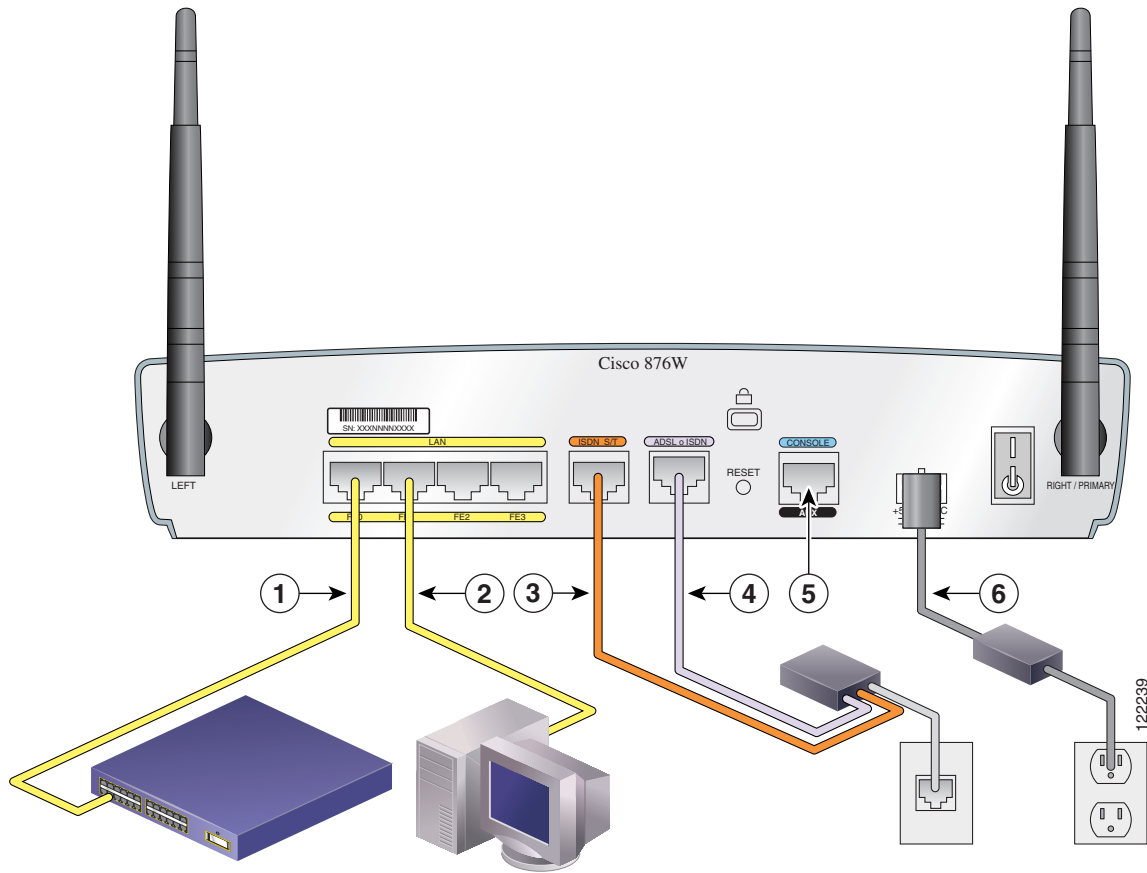

1	Ethernet connection to an external switch	4	ADSL-over-ISDN connection
2	Ethernet connection to a PC	5	Console port
3	ISDN S/T connection	6	Power adapter

Figure 4-4 Typical Installation of a Cisco 878 Router

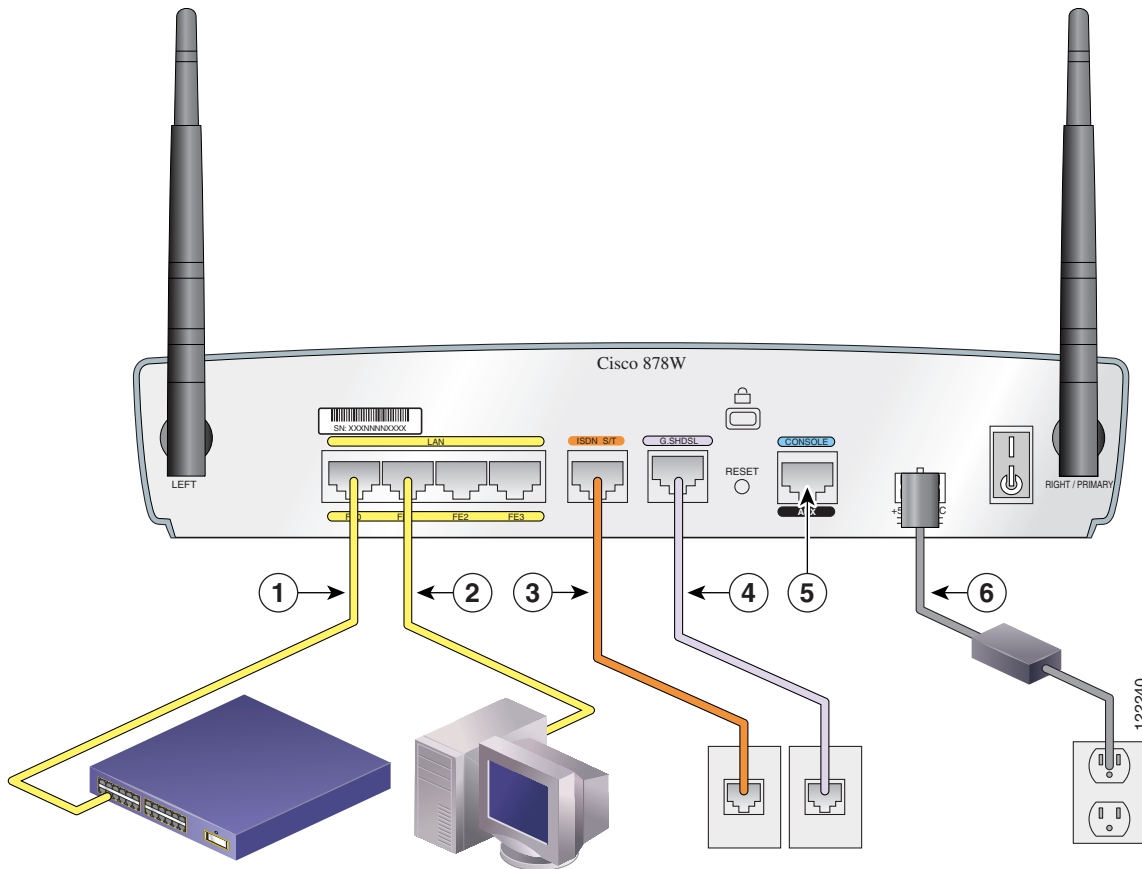

1	Ethernet connection to an external switch	4	G.SHDSL connection
2	Ethernet connection to a PC	5	Console port
3	ISDN S/T connection	6	Power adapter

Connecting the Radio Antennas to the Wireless Router

If you selected the wireless option for the router, follow these steps to attach the radio antennas:

-
- Step 1** Attach an antenna to a reverse-polarity threaded Neill-Concelman (RP-TNC) connector on the back of the router and tighten the antenna hand-tight.
- Step 2** Orient the antenna vertically:
- a. If the router is being mounted on a desk, orient the antenna straight up.
 - b. If the router is being mounted on a wall, orient the antenna straight down.
-

Connecting the Power-over-Ethernet Module (Optional)

If you purchased a power-over-Ethernet (PoE) module to provide inline power to devices, connect the four Ethernet cables on the PoE module to the four LAN Ethernet ports on the router. Make sure you connect all four Ethernet cables. If the cables are too close together for easy insertion, move the plastic cable guard away from the connector end of the cable. See [Figure 4-5](#).



Caution

Do not connect the PoE module power supply to the PoE module before you connect the PoE module to the router. For information about connecting the power supply to the PoE module, see the “[Connecting the AC Adapter](#)” section.

Figure 4-5 Connecting the Power-over-Ethernet Module to the Router

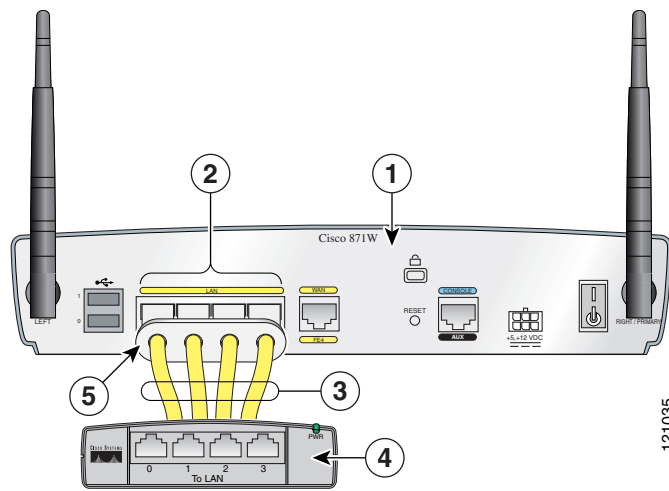

1	Router	4	PoE module
2	Router Ethernet ports	5	Plastic cable guard
3	Ethernet cables connecting the PoE module to the router		

After you connect the PoE module to the router, connect the Ethernet devices to the ports on the PoE module, rather than to the Ethernet ports on the router.



Note

When you connect a device (such as a PC or IP phone) to the PoE module, you may notice a 1- to 2-second delay before the LED indicator for the port comes on.

Connecting a Server, PC, or Workstation

To connect a server, PC, or workstation to a built-in Ethernet switch port, follow the steps given after [Figure 4-6](#), which shows a Cisco 871W router connected to a PC. The procedure applies to Cisco 850 series and Cisco 870 series routers.

Figure 4-6 Connecting a Server, PC, or Workstation

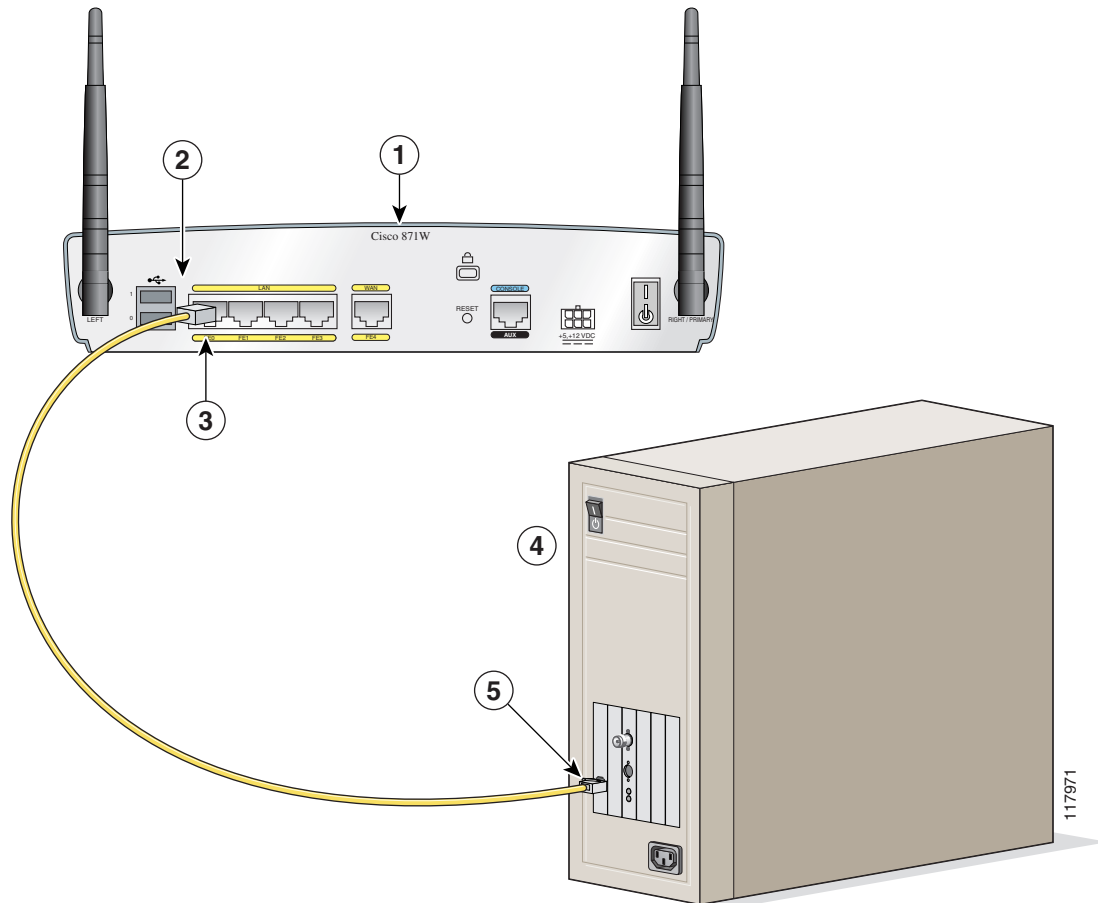

1	Router	4	PC
2	Yellow Ethernet cable	5	RJ-45 port on the network interface card (NIC)
3	Built-in Ethernet switch port on the router		

Perform the following steps to connect the PC (or other Ethernet devices) to a port on the built-in Ethernet switch.

**Caution**

Leave the PCs turned off until after you have completed all connections to the router.

-
- Step 1** Connect one end of the yellow Ethernet cable to a built-in Ethernet switch port on the router.
- Step 2** Connect the other end of the cable to the RJ-45 port on the NIC installed in the PC, server, or workstation.
- Step 3** (Optional) Connect additional servers, PCs, or workstations to the other built-in Ethernet switch ports.
-

Connecting an External Ethernet Switch (Optional)

If more than four PCs need to be connected to each other in an office, you may connect an external Ethernet switch to the router's built-in switch to add additional Ethernet connections to the router.

Although [Figure 4-7](#) shows a Cisco 871 router, the procedure in this section applies to all Cisco 850 series and Cisco 870 series routers.

To connect an external Ethernet switch to a built-in Ethernet switch port on the router, follow the steps given after [Figure 4-7](#), which shows this connection.

Figure 4-7 Connecting to an Ethernet Switch

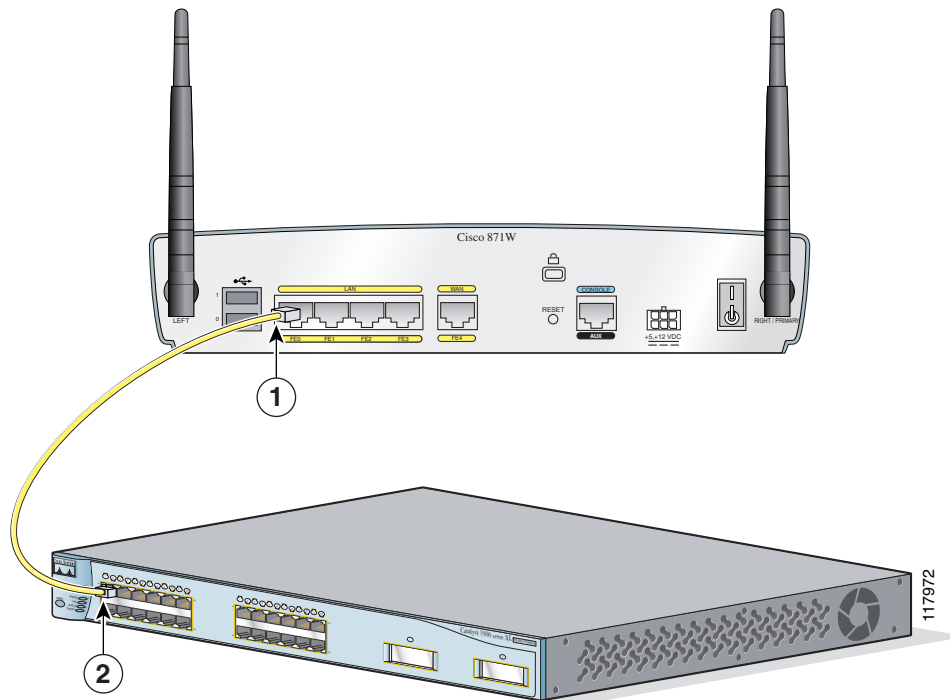

1 Yellow Ethernet cable connecting an external Ethernet switch to a built-in Ethernet switch port on the router	2 Available port on the external Ethernet switch
--	---

Perform the following steps to connect the router to an external Ethernet switch:

-
- Step 1** Connect one end of the yellow Ethernet cable to a built-in Ethernet switch port on the router.
 - Step 2** Connect the other end of the cable to the available port on the Ethernet switch to add additional Ethernet connections.
 - Step 3** Turn on the Ethernet switch.
-

Connecting a Broadband Modem

This section applies only to Cisco 851 and Cisco 871 routers. You can connect to the Internet by connecting a broadband modem. To connect to an installed DSL, cable, or long-reach Ethernet modem, follow the steps given after Figure 4-8, which shows this connection.

Figure 4-8 Connecting to a Broadband Modem

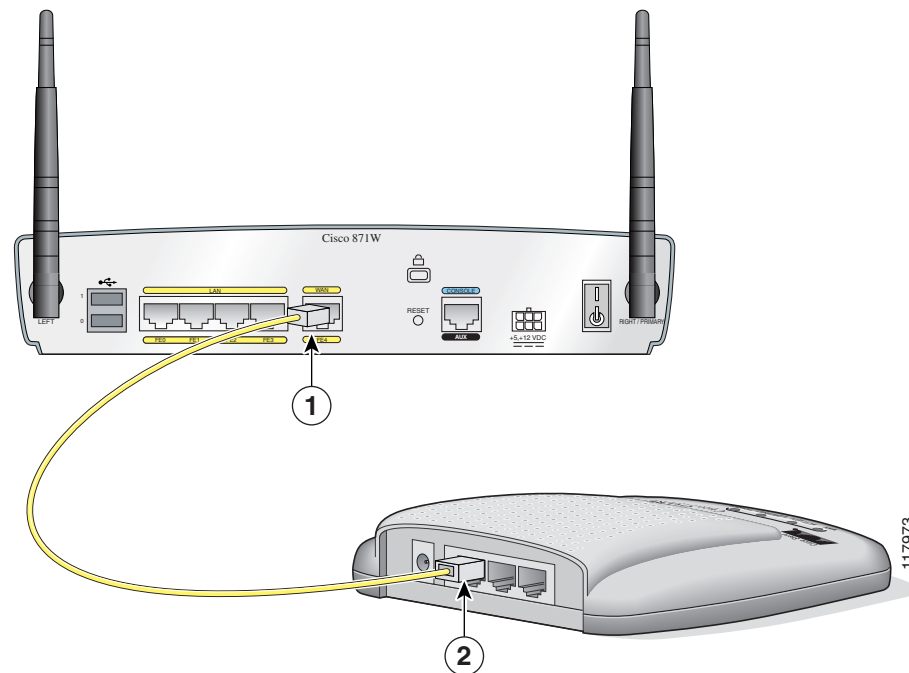

1	Ethernet WAN port on the router	2	Available port on the modem
----------	---------------------------------	----------	-----------------------------

Perform the following steps to connect the router to an installed DSL, cable, or long-reach Ethernet modem:

-
- Step 1** Connect one end of the yellow cable to the Ethernet WAN FE4 port.
 - Step 2** Connect the other end of cable to an available port on the modem.
 - Step 3** Follow the instructions provided with your broadband modem to determine which port on the modem to connect to.
 - Step 4** Turn on the broadband modem if it is not already turned on.
-



Note

It is recommended that you use the Cisco Router and Security Device Manager (SDM) application to configure the Internet connection settings. See the *Cisco Router and Security Device Manager (SDM) Quick Start Guide* for more information.

Connecting a Terminal or PC to the Console Port

The console port is a service port to which you can connect a terminal or PC either to configure the software by using the command-line interface (CLI) or to troubleshoot problems with the router.

Although [Figure 4-9](#) shows a Cisco 871W router, the procedure in this section applies to all Cisco 850 series and Cisco 870 series routers.

To connect a terminal or PC to the console port, follow the steps given after [Figure 4-9](#).

Figure 4-9 Connecting a Terminal or PC to the Console Port

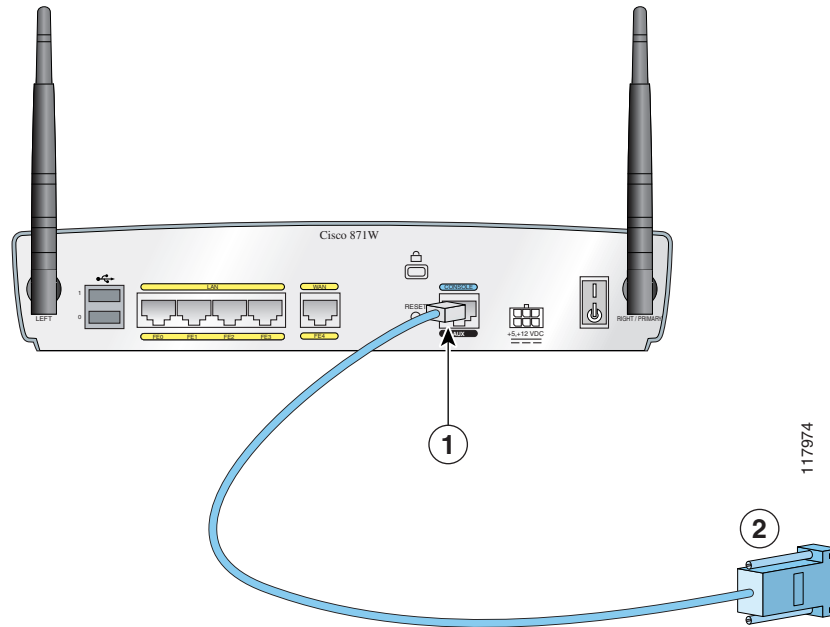

1 Console port on the router

2 DB-9 connector

Perform the following steps to connect the router's console port to a terminal or PC:

-
- Step 1** Connect the RJ-45 connector on the light blue cable to the router console port.
 - Step 2** Connect the DB-9 connector to a terminal or PC.
-

Connecting an Async Modem to the Console Port

The Cisco 850 series and Cisco 870 series routers support the dial backup function, which allows a user to connect an analog modem to the console port as a backup link to the WAN port in case the ADSL service goes down.

Note

To connect an analog modem to the console port, you will need an optional router modem cable. Contact your router vendor to order this cable.

Although [Figure 4-10](#) shows the async modem connection to the console port on the Cisco 857 router, this connection applies to all Cisco 850 series and Cisco 870 series routers.

Figure 4-10 Connecting an Async Modem to the Console Port

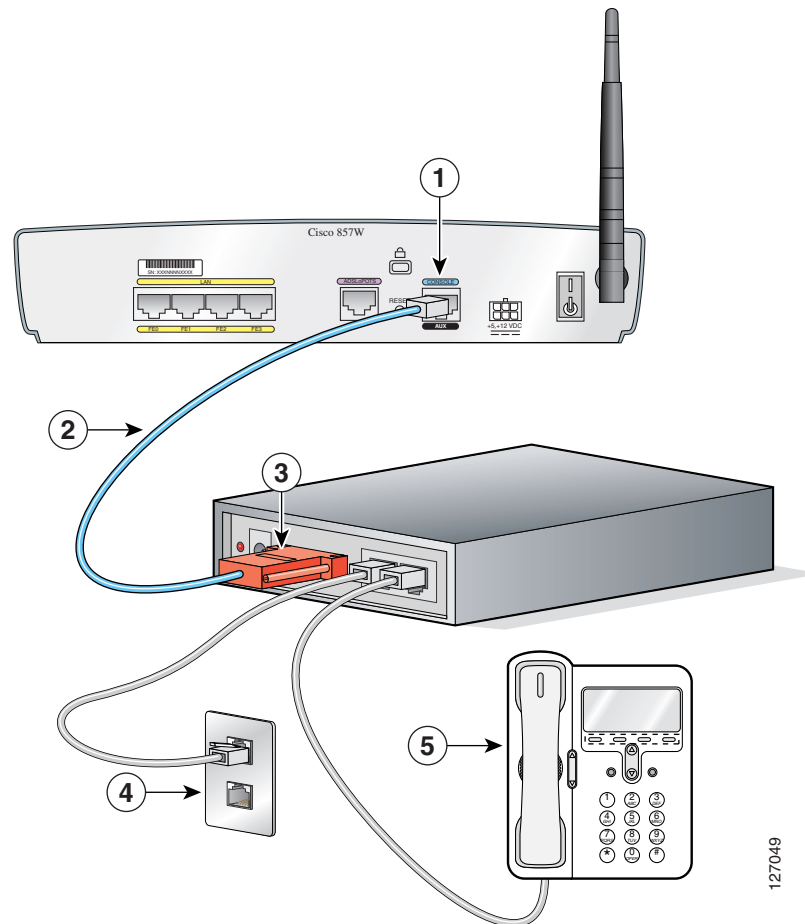

127049

1	Router console port	4	Wall jack connected by an RJ-11 telephone cable to a port on an async modem
2	Router modem cable	5	Telephone connected by an RJ-11 telephone cable to a port on an async modem (optional)
3	Available port on an async modem		

Perform the following steps to connect the console port on the router to an async modem:

-
- Step 1** Connect the RJ-45 end of the router modem cable to the console port.
- Step 2** Connect the DB-25 connector end of the router modem cable to an available port on the async modem.
- Step 3** Connect one end of the RJ-11 telephone cable to a wall jack, and then connect the other end of the RJ-11 cable to the modem.
- Step 4** (Optional) Connect one end of an RJ-11 telephone cable to a telephone, fax, or other device, and then connect the other end of the RJ-11 cable to the modem.
-

Connecting an ISDN S/T Port

This section applies to Cisco 876 and Cisco 878 routers. You can connect the ISDN S/T port to the ISDN service provider as a backup link to the WAN port in case the ADSL service goes down.

The cabling requirements and information for the ISDN S/T connection follow:

- You must provide two unshielded Category 5 cables. The first cable connects the NT1 box to the splitter, and the second cable connects the splitter to the wall jack.
- There are RJ-45 connectors at both ends of the default orange ISDN S/T cable. However, an RJ-45-to-RJ-11 ISDN S/T cable is available upon request if the wall jack at the site requires an RJ-11 connector. Contact your router reseller for the appropriate cable.



Caution

Both LAN and WAN ports can use RJ-45 connectors. Use caution when connecting cables to these connectors. To avoid damage to the router, do not connect telephone-network voltage (TNV) circuits (such as ISDN or DSL circuits) to safety extra-low voltage (SELV) circuits (such as LAN circuits).

Although [Figure 4-11](#) shows an ISDN S/T connection for a Cisco 876 router, this connection also applies to a Cisco 878 router.

Figure 4-11 Connecting the ISDN S/T Port to the ISDN Service Provider

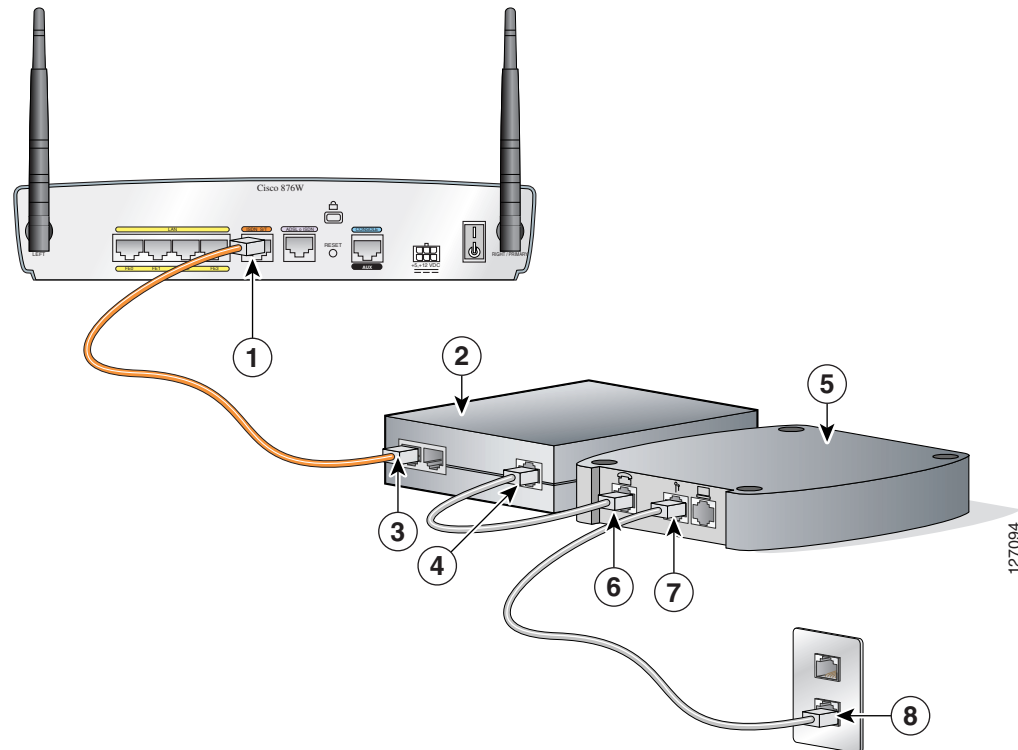

1	One end of the ISDN S/T cable that connects to the ISDN S/T port on the router	5	ADSL splitter that is provided by the ADSL service provider
2	Network termination 1 (NT1) box	6	Other end of the first unshielded Category 5 cable that connects to the telephone line port on the splitter
3	Other end of the ISDN S/T cable that connects to the S/T port on the NT1 box	7	One end of the second unshielded Category 5 cable that connects to the telecommunication service port on the splitter
4	One end of the first unshielded Category 5 cable that connects to the U port on the NT1 box	8	Other end of the second unshielded Category 5 cable that connects to the wall jack

Perform the following steps to connect the ISDN S/T port to the ISDN service provider:

-
- Step 1** Connect one end of the orange ISDN S/T cable to the ISDN S/T port on the router.
- Step 2** Connect the other end of the orange ISDN S/T cable to the S/T port on the NT1 box.
- Step 3** Connect the first unshielded Category 5 cable from the U port on the NT1 box to the telephone line port on the splitter.
- Step 4** Connect the second unshielded Category 5 cable from the telecommunication service port on the splitter to the wall jack to allow a link to the network service provider.
-

Connecting an ADSL Line—ADSLoPOTS Port

This section applies only to Cisco 857 and Cisco 877 routers. Follow the steps shown after [Figure 4-13](#) to connect an asymmetric digital subscriber line (ADSL) over plain old telephone service (ADSLoPOTS) port on the router.

Note

The DSL line must have been provisioned by your service provider and correctly configured for the LED to show the carrier detect (CD) status. If the CD LED is not on, check with the DSL service provider.

Figure 4-12 Connecting the ADSLoPOTS Port to an ADSL Line

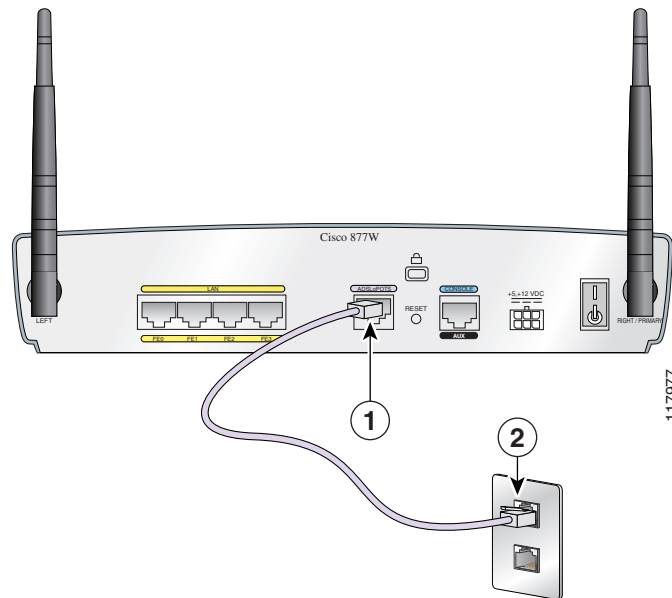

1	ADSLoPOTS port on the router	2	End of ADSL cable that connects to the wall jack
----------	------------------------------	----------	--

Perform the following steps to connect the ADSL cable to a cable wall jack:

-
- Step 1** Connect one end of the ADSL cable to the ADSLoPOTS port on the router.
- Step 2** Connect the other end of the cable to the wall jack.
-

Connecting an ADSL Line—ADSLoISDN Port

This section applies only to the Cisco 876 router. The procedure for connecting an asymmetric digital subscriber line (ADSL) depends on the router and, in some cases, on the location. Follow the steps shown after [Figure 4-13](#) to connect the ADSL cable to a cable wall jack.



Note

The DSL line must have been provisioned by your service provider and correctly configured for the ADSL CD LED to show the status. If the ADSL CD LED is not on, check with the DSL service provider.

Note

You must provide the unshielded Category 5 cable for connecting to the ADSL ISDN splitter that is provided by the service provider.

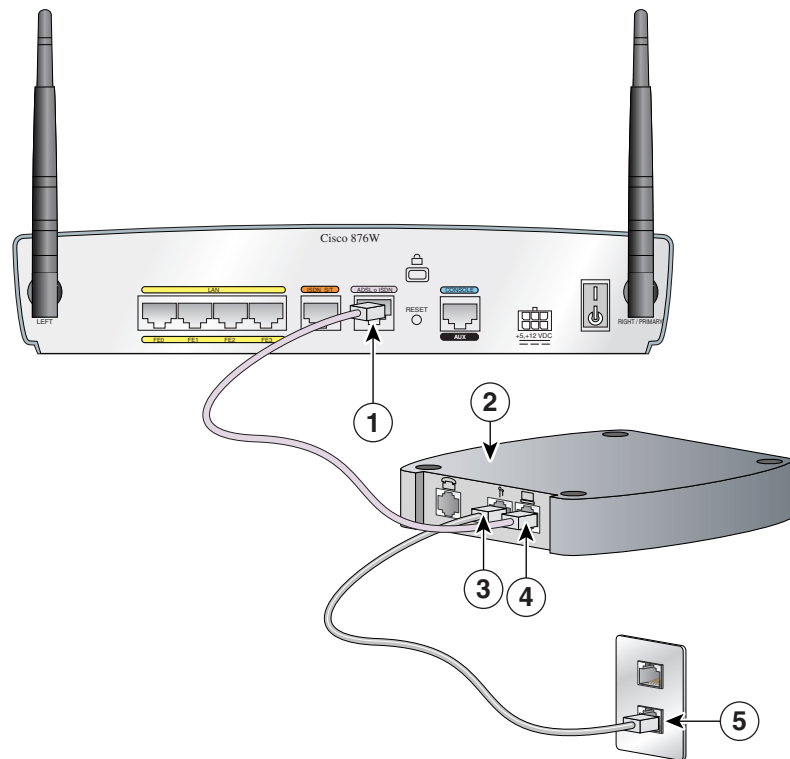
Figure 4-13 Connecting the ADSLoISDN Port to an ADSL Line



1	One end of the ADSL cable that connects to the router	4	RJ-11 end of the ADSL cable that connects to the splitter
2	ADSL splitter	5	Other end of the unshielded Category 5 cable that connects to the wall jack
3	RJ-11 end of an unshielded Category 5 cable that connects to the splitter		

Perform the following steps to connect the ADSL line to a cable wall jack:

-
- Step 1** Connect the RJ-11 end of the ADSL cable to the ADSLoISDN port on the router.
 - Step 2** Connect the other RJ-11 end of the ADSL cable to the local ADSL connector port on the ADSL splitter (provided by the ADSL service provider).
 - Step 3** Connect the unshielded Category 5 cable from the outside ADSL port on the splitter to a wall jack.
-

Connecting a G.SHDSL Line

This section applies to the Cisco 878 router only. To connect the router to a G.SHDSL line, perform the steps given after [Figure 4-14](#).

Figure 4-14 Connecting the G.SHDSL Line

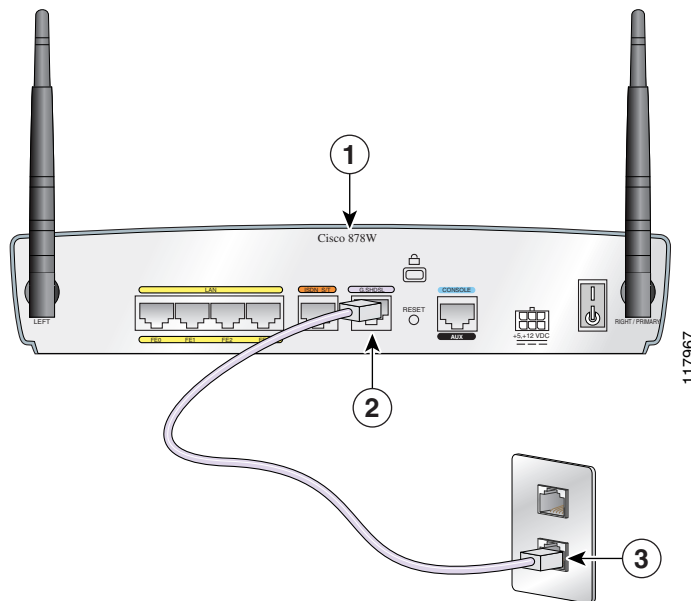

1	G.SHDSL port on the router	2	DSL wall jack
----------	----------------------------	----------	---------------

Perform the following steps to connect the router to an installed DSL:

-
- Step 1** Connect one end of the lavender DSL cable to the G.SHDSL port on the router.
 - Step 2** Connect the other end of the cable to the DSL wall jack.
-

Connecting the AC Adapter

To connect the AC adapter, follow the steps given after [Figure 4-15](#). Although the illustration shows the Cisco 871W router, the procedure applies to all Cisco 850 series and Cisco 870 series routers.

 **Warning**

The device is designed to work with TN power systems. Statement 19

 **Warning**

This product relies on the building's installation for short-circuit (overcurrent) protection. Ensure that a fuse or circuit breaker no larger than 120VAC, 20A U.S. (240VAC, 16 to 20A international) is used on the phase conductors (all current-carrying conductors). The fuse or circuit breaker must have adequate safety approvals recognized by the country of usage. Statement 119

Figure 4-15 Connecting the AC Adapter (No PoE Module)

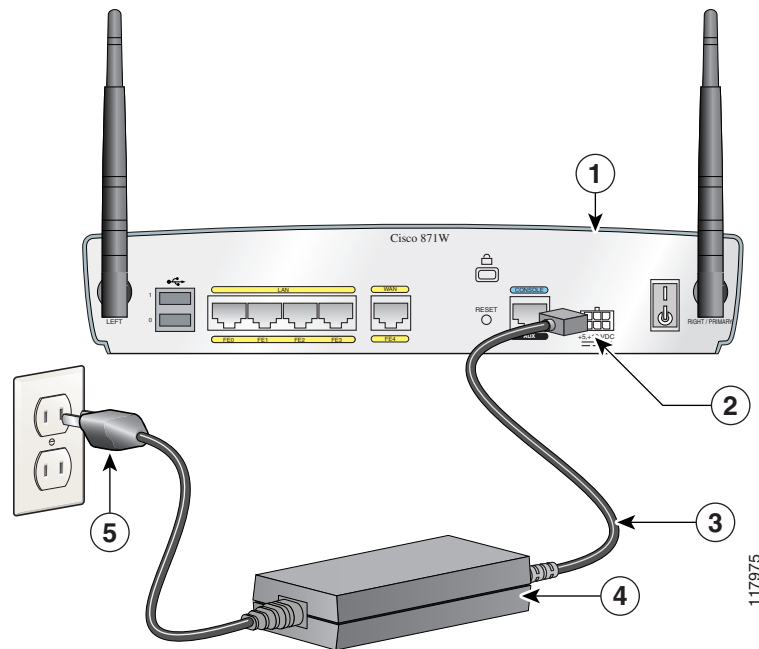

1	Router	4	Desktop power adapter
2	Router input jack	5	Power cord plug
3	Power cord		

Figure 4-16 Connecting AC Adapters to the Router and to the PoE Module

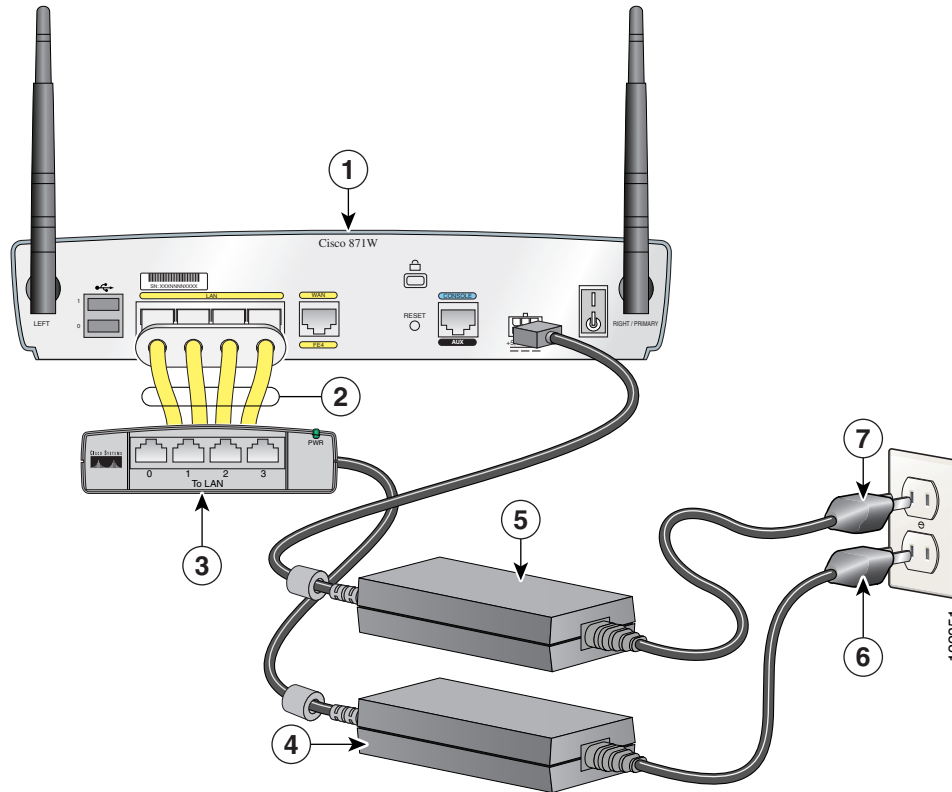

1	Router	5	Router power adapter
2	Ethernet cables on the PoE module	6	PoE module power adapter plug
3	PoE module	7	Router power adapter plug
4	PoE module power adapter		

Perform the following steps to connect power to the router and to the PoE module:

-
- Step 1** Connect one end of the power supply cable to the input jack of the router.
- Step 2** Connect the other end of the power supply cable to the router power adapter.
- Step 3** If a PoE module is connected to the router, connect the PoE module power adapter to the PoE module.
- Step 4** Plug the power cord of the router power adapter into an electrical outlet. If a PoE module is connected to the router, plug the power cord for the PoE module into an electrical outlet.
-

Verifying Router Operations

To verify that all devices are properly connected to the router, turn on all the connected devices; then use [Table 4-1](#) to help you verify correct router operation by checking the LEDs.

Table 4-1 Verifying the Router Operation

Power and Link	LEDs to Check	Normal Patterns
Power	OK	On when power is supplied to router.
To servers, PCs, or workstations connected to the LAN ports (FE0, FE1, FE2, or FE3)	ETHERNET LAN 0, ETHERNET LAN 1, ETHERNET LAN 2, or ETHERNET LAN 3	ETHERNET LAN 0, ETHERNET LAN 1, ETHERNET LAN 2, or ETHERNET LAN 3 is on when the LAN port is physically connected to a server, PC, or workstation.
	WAN RXD	WAN RXD blinks when a port on the built-in Ethernet switch receives an Ethernet packet.
	WAN TXD	WAN TXD blinks when a port on the built-in Ethernet switch sends an Ethernet packet.
To broadband modem, or to an external Ethernet switch	WAN LNK	WAN LNK is on when the WAN port is physically connected to a broadband modem or to an external Ethernet switch.
	WAN RXD	WAN RXD blinks when the WAN port receives an Ethernet packet.
	WAN TXD	WAN TXD blinks when the WAN port sends an Ethernet packet.
To xDSL line (ADSL or G.SHDSL)	ADSL CD, G.SHDSL CD	WAN xDSL carrier detect status: <ul style="list-style-type: none"> On when the line is connected to the ADSL or G.SHDSL DSLAM. Blinks when the router tries to connect to the ADSL or G.SHDSL DSLAM.
	ADSL RXD, G.SHDSL RXD	ADSL RXD or G.SHDSL RXD blinks when the xDSL line receives a packet.
	ADSL TXD, G.SHDSL TXD	ADSL RXD or G.SHDSL TXD blinks when the xDSL line sends a packet.
To ISDN line	ISDN LNK	ISDN line status—Green if the ISDN line is up.
	ISDN B1 and ISDN B2	ISDN BRI channel status—Orange if the channel is up.
To PPP clients	PPP	PPP is on if either a PPPoE or PPPoA client is running.
To VPN tunnel	VPN	VPN is on if a crypto session is running.
To wireless LAN	WLAN OK	Wireless LAN link status: <ul style="list-style-type: none"> Solid green if at least one client is associated. Blinks if no client is associated.
	WLAN DATA	WLAN DATA is on if there is traffic on the wireless link.

What to Do Next

After verifying that the router cabling is correct and the power up is successful, perform the initial configuration of the router as described in [Chapter 5, “Initial Configuration.”](#)



Initial Configuration

This chapter provides instructions for performing the initial configuration of the router, and contains the following sections:

- [Installing Cisco Router and Security Device Manager, page 5-1](#)
- [Initial Configuration Using Cisco SDM, page 5-1](#)
- [Initial Configuration Using the Setup Command Facility, page 5-2](#)
- [Initial Configuration Using the Cisco CLI—Manual Configuration, page 5-4](#)
- [Verifying the Initial Configuration, page 5-5](#)
- [What to Do Next, page 5-5](#)

Installing Cisco Router and Security Device Manager

Once you have completed the cable connections and powered up the router, we recommend that you use the Cisco Router and Security Device Manager (SDM) web-based application to configure the initial router settings.

To install Cisco SDM for configuring the router, follow these steps:

-
- Step 1** Connect a PC to the router console port.
 - Step 2** Insert the Cisco SDM software CD into the CD drive of the PC to launch an installation wizard. Install Cisco SDM by following the instructions on the installation wizard user interface.
 - Step 3** Use Cisco SDM to configure the router by following the instructions in the *Cisco Router and Security Device Manager (SDM) Quick Start Guide*.
-

Initial Configuration Using Cisco SDM

If the following messages appear at the end of the startup sequence, Cisco SDM is installed on your router:

```
yourname con0 is now available
```

```
Press RETURN to get started.
```

For instructions on configuring your router by using SDM, see the *Cisco Router and Security Device Manager (SDM) Quick Start Guide*.

Initial Configuration Using the Setup Command Facility

This section describes how to use the setup command facility to configure a hostname for the router, set passwords, and configure an interface for communication with the management network.

If the following messages appear at the end of the startup sequence, the setup command facility has been invoked automatically:

```
--- System Configuration Dialog ---
```

```
At any point you may enter a question mark '?' for help.
Use ctrl-c to abort configuration dialog at any prompt.
Default settings are in square brackets '['].
```

```
Would you like to enter the initial configuration dialog? [yes/no]:
```

The setup command facility prompts you for basic information about your router and network, and it creates an initial configuration file. After the configuration file is created, you can use the CLI or Security Device Manager to perform additional configuration.

The prompts in the setup command facility vary, depending on your router model, the installed interface modules, and the software image. The following example and the user entries (in **bold**) are shown as examples only.



Note

If you make a mistake while using the setup command facility, you can exit and run the setup command facility again. Press **Ctrl-C**, and enter the **setup** command at the privileged EXEC mode prompt (Router#).

Step 1 To proceed using the setup command facility, enter **yes**:

```
Would you like to enter the initial configuration dialog? [yes/no]: yes
```

Step 2 When the following messages appear, enter **yes** to enter basic management setup:

```
At any point you may enter a question mark '?' for help.
Use ctrl-c to abort configuration dialog at any prompt.
```

```
Default settings are in square brackets '['].
```

```
Basic management setup configures only enough connectivity
for management of the system, extended setup will ask you
to configure each interface on the system
```

```
Would you like to enter basic management setup? [yes/no]: yes
```

Step 3 Enter a hostname for the router (this example uses Router):

```
Configuring global parameters:
Enter host name [Router]: Router
```

- Step 4** Enter an enable secret password. This password is encrypted (more secure) and cannot be seen when viewing the configuration:

The enable secret is a password used to protect access to privileged EXEC and configuration modes. This password, after entered, becomes encrypted in the configuration.

Enter enable secret: **xxxxxxx**

- Step 5** Enter an enable password that is different from the enable secret password. This password is *not* encrypted (less secure) and can be seen when viewing the configuration:

The enable password is used when you do not specify an enable secret password, with some older software versions, and some boot images.

Enter enable password: **xxxxxxx**

- Step 6** Enter the virtual terminal password, which prevents unauthenticated access to the router through ports other than the console port:

The virtual terminal password is used to protect access to the router over a network interface.

Enter virtual terminal password: **xxxxxxx**

- Step 7** Respond to the following prompts as appropriate for your network:

Configure SNMP Network Management? [yes]:
Community string [public]:

A summary of the available interfaces is displayed.

- Step 8** Choose one of the available interfaces for connecting the router to the management network:

Enter interface name used to connect to the management network from the above interface summary: **fastethernet0**

- Step 9** Respond to the following prompts as appropriate for your network:

Configuring interface FastEthernet0:
Use the 100 Base-TX (RJ-45) connector? [yes]: **yes**
Operate in full-duplex mode? [no]: **no**
Configure IP on this interface? [yes]: **yes**
IP address for this interface: **172.1.2.3**
Subnet mask for this interface [255.255.0.0] : **255.255.0.0**
Class B network is 172.1.0.0, 26 subnet bits; mask is /16

- Step 10** The configuration is displayed:

The following configuration command script was created:

```
hostname Router
enable secret 5 $1$D5P6$PYx41/lQIASK.HcSbf05q1
enable password xxxxxx
line vty 0 4
password xxxxxx
snmp-server community public
!
no ip routing
!
interface FastEthernet0
no shutdown
speed 100
half-duplex
ip address 172.1.2.3 255.255.0.0
!
```

Step 11 Respond to the following prompts. Enter **2** to save the initial configuration.

```
[0] Go to the IOS command prompt without saving this config.
[1] Return back to the setup without saving this config.
[2] Save this configuration to nvram and exit.
```

```
Enter your selection [2]: 2
Building configuration...
Use the enabled mode 'configure' command to modify this configuration.
```

```
Press RETURN to get started! RETURN
```

The user prompt is displayed.

```
Router>
```

Step 12 Verify the initial configuration. See the “[Verifying the Initial Configuration](#)” section for verification procedures.

Initial Configuration Using the Cisco CLI—Manual Configuration

This section shows how to display a command-line interface (CLI) prompt for configuration using the CLI, and it directs you to documentation for the CLI configuration.

You can use the CLI if the following messages appear at the end of the startup sequence:

```
--- System Configuration Dialog ---
```

```
At any point you may enter a question mark '?' for help.
Use ctrl-c to abort configuration dialog at any prompt.
Default settings are in square brackets '['].
```

```
Would you like to enter the initial configuration dialog? [yes/no]:
```

If these messages do not appear, SDM and a default configuration file were installed on the router. To use SDM to configure the router, see the “[Initial Configuration Using Cisco SDM](#)” section.



Note

Be sure to save your configuration changes occasionally so that they are not lost during resets, power cycles, or power outages. Use the **copy running-config startup-config** command at the privileged EXEC mode prompt (Router#) to save the configuration to NVRAM.

Step 1 To proceed with manual configuration using the CLI, enter **no** when the power-up messages end.

```
Would you like to enter the initial configuration dialog? [yes/no]: no
```

Step 2 Press **Return** to terminate autoinstall and continue with manual configuration.

```
Would you like to terminate autoinstall? [yes] Return
```

```
Several messages appear, ending with a line similar to the following:
Copyright (c) 1986-2004 by Cisco Systems, Inc.
Compiled <date> <time> by <person>
```

Step 3 Press **Return** to display the Router> prompt.

```
...  
flashfs[4]: Initialization complete.  
Router>
```

Step 4 Enter privileged EXEC mode.

```
Router> enable  
Router#
```

Step 5 For configuration using the CLI, see the applicable configuration procedures in the *Cisco 850 Series and Cisco 870 Series Access Routers Software Configuration Guide*.

Step 6 Verify the initial configuration. See the “[Verifying the Initial Configuration](#)” section for verification procedures.

Verifying the Initial Configuration

To verify that the new interfaces are operating correctly, perform the following tests:

- To verify that the interfaces are operating correctly and that the interfaces and line protocol are in the correct state—up or down—enter the **show interfaces** command.
- To display a summary status of the interfaces configured for IP, enter the **show ip interface brief** command.
- To verify that you configured the correct hostname and password, enter the **show configuration** command.

After you have completed and verified the initial configuration, you can configure your Cisco router for specific functions.

What to Do Next

For information and instructions on how to perform additional configurations for the router, see the *Cisco 850 Series and Cisco 870 Series Access Routers Software Configuration Guide*.



Troubleshooting

This chapter describes problems that could occur with the router hardware, possible causes of the problems, and steps for solving the problems. This chapter contains the following sections:

- [Before You Call Your Cisco Reseller, page 6-1](#)
- [Problems During First Startup, page 6-2](#)
- [Problems After the Router Is Running, page 6-3](#)

For more information on problems that could occur with the software, see the *Cisco 850 Series and Cisco 870 Series Access Routers Software Configuration Guide*.

Before You Call Your Cisco Reseller

Some of the solutions in this chapter instruct you to contact your Cisco reseller. Before you contact your reseller, have the following information ready:

Type of Information	Your Information
Router model and serial number (on the back panel)	
Maintenance agreement or warranty information	
Date you received the router	
Brief description of the problem	
Brief description of the steps you have taken to resolve the problem	

Problems During First Startup

Table 6-1 lists problems that could occur the first time you turn on the router.

Table 6-1 Problems During First Startup

Symptom	Problem	Solutions
All LEDs, including OK LED, are off.	No power to router.	Perform the following tasks in order: <ol style="list-style-type: none"> 1. Make sure that the power switch is set to ON. 2. Make sure that all connections to and from the power supply are secure. 3. Make sure that the power outlet has power. 4. If the problem continues, the power supply could be faulty. Contact your Cisco reseller.
No connection to modem or to Ethernet switch. (WAN LNK LED is off.)	A cable-related problem: <ul style="list-style-type: none"> • Improperly connected cable. • Damaged cable. 	Perform the following tasks in order: <ol style="list-style-type: none"> 1. Make sure that you have cabled the device correctly. Review the instructions in Chapter 4, “Router Cabling Procedures.” 2. Make sure that the connectors at both ends of the cable are securely seated. 3. Check whether the cable is physically damaged. If it is damaged, order another cable from Cisco, or replace it with a similar cable.
No connection to Ethernet devices. (ETHERNET LAN 0, ETHERNET LAN 1, ETHERNET LAN 2, and ETHERNET LAN 3 LEDs are off.)	A cable-related problem: <ul style="list-style-type: none"> • Improperly connected cable. • Damaged cable. 	Perform the following tasks in order: <ol style="list-style-type: none"> 1. Make sure that you have cabled the device correctly. See Chapter 4, “Router Cabling Procedures.” 2. Make sure that the connectors at both ends of the cable are securely seated. 3. Check whether the cable is physically damaged. If it is damaged, order another cable from Cisco Systems, or replace it with a similar cable.
Cannot connect to the Internet.	<ul style="list-style-type: none"> • Broadband modem or external Ethernet switch is not connected or turned on. • There is a problem with the broadband or WAN service. • Router is improperly configured. 	<ul style="list-style-type: none"> • Reconnect the broadband modem or external Ethernet switch, and make sure that it is receiving power. • Check with the Internet service provider or corporate network administrator to determine whether there is a problem. • Use the Cisco Router and Security Device Manager (SDM) software to configure the router, or configure the router using a PC that is connected to the console port.
No connection to xDSL link. (The WAN LNK LED on the front panel is off for a long time.)	Wrong cable.	<ul style="list-style-type: none"> • Make sure that you are using the correct cable. See Appendix A, “Specifications.”

Table 6-1 Problems During First Startup (continued)

Symptom	Problem	Solutions
No connection to xDSL link. (The WAN LNK LED on the front panel is off for a long time.)	Improperly connected cable.	<ul style="list-style-type: none"> Make sure that you have connected the ADSL cable properly. See Chapter 4, “Router Cabling Procedures.” Make sure that the connectors at both ends of the cable are securely seated.
No connection to xDSL link. (The CD LED on the front panel is off for a long time.)	Wrong cable.	<ul style="list-style-type: none"> Make sure that you are using the correct cable. See Appendix A, “Specifications.”
No connection to xDSL link. (The CD LED on the front panel is off for a long time.)	Improperly connected cable.	<ul style="list-style-type: none"> Make sure that you have connected the ADSL cable properly. See Chapter 4, “Router Cabling Procedures.” Make sure that the ADSL port is connected to the correct port on the ISDN splitter. Make sure that the connectors at both ends of the cable are securely seated.

Problems After the Router Is Running

[Table 6-2](#) lists problems that could occur after the router has been up and running.

Table 6-2 Problems After the Router Is Running

Symptom	Problem	Solutions
Problems with Ethernet connection. (ETHERNET LAN 0, ETHERNET LAN 1, ETHERNET LAN 2, and ETHERNET LAN 3 LEDs are off.)	A cable-related problem: <ul style="list-style-type: none"> Disconnected cable. Damaged cable. 	Perform the following tasks in order: <ol style="list-style-type: none"> Make sure that the connectors at both ends of the cable are secure. Check whether the cable is physically damaged. If it is damaged, order another cable from Cisco Systems, or replace it with a similar cable.
Connection to the broadband or Ethernet line is intermittent or lost. (The WAN LNK, ADSL CD, or G.SHDSL CD LED on the front panel is off.)	A cable-related problem: <ul style="list-style-type: none"> Disconnected cable. Damaged cable. 	Perform the following tasks in order: <ol style="list-style-type: none"> Make sure that the connectors at both ends of the cable are secure. Make sure that the cable is not physically damaged. If it is damaged, order another cable from Cisco Systems, or replace it with a similar cable.
Connection to the broadband or Ethernet line is intermittent or lost. (The WAN LNK, ADSL CD, or G.SHDSL CD LED on the front panel is off.)	Problem with broadband line or WAN service.	Contact your broadband line or WAN service provider to determine whether there is a problem.

Table 6-2 Problems After the Router Is Running (continued)

Symptom	Problem	Solutions
Connection to the xDSL line is intermittent or lost. (The ADSL CD or G.SHDSL CD LED on the front panel is off.)	A cable-related problem: <ul style="list-style-type: none"> • Disconnected cable. • Damaged cable. 	<ul style="list-style-type: none"> • Make sure that the connectors are secure at both ends of the cable. • Check whether the cable is physically damaged. If it is damaged, order another cable from Cisco Systems or replace it with a similar cable.
Connection to the xDSL line or WAN port is loose. (The WAN LNK LED and the ETHERNET LAN 0, ETHERNET LAN 1, ETHERNET LAN 2, or ETHERNET LAN 3 LED on the front panel are off.)	Problem with DSL line or WAN service.	Contact your DSL line or WAN service provider to determine whether there is a problem with the DSL or WAN service.
Connection to the xDSL line is intermittent or lost. (The ADSLCD or G.SHDSL CD LED on the front panel is off.)	A cable-related problem: <ul style="list-style-type: none"> • Disconnected cable. • Damaged cable. 	<ul style="list-style-type: none"> • Make sure that the Ethernet port is not configured to be administratively down. • Make sure that the device connected to the Ethernet port is connected, powered on, and properly configured. • Make sure that the connectors at both ends of the cable are secure. • Check whether the cable is physically damaged. If it is damaged, order another cable from Cisco Systems or replace it with a similar cable.
Connection to the xDSL line or WAN is lost. (The ADSL CD or G.SHDSL CD LED and the ETHERNET LAN 0, ETHERNET LAN 1, ETHERNET LAN 2, or ETHERNET LAN 3 LED on the front panel are off).	Problem with xDSL or WAN service.	<ul style="list-style-type: none"> • Check all passwords and device names to make sure that they are correct. • Contact your DSL line or WAN service provider to determine whether there is a problem with the ADSL or WAN service.



Specifications

This appendix provides system, port, and cabling specifications for Cisco 850 series and Cisco 870 series routers. It contains the following sections:

- [Router Specifications, page A-1](#)
- [Power-over-Ethernet Module Specifications, page A-2](#)
- [LAN Port Pinouts, page A-3](#)
- [Console Connector Pinouts, page A-4](#)
- [ADSL Port Connector Pinouts, page A-4](#)
- [Cable Specifications, page A-5](#)

Router Specifications

[Table A-1](#) outlines the system specifications for the routers.

Table A-1 Router Specifications

Description	Design Specification
Physical Dimensions	
Dimensions (H x W x D)	<ul style="list-style-type: none"> • With antenna connectors: 2.0 x 10.25 x 9.13 in. (51 x 260 x 232 mm) • Without antenna connectors: 2.0 x 10.25 x 8.5 in. (51 x 260 x 216 mm)
Weight (not including desktop power supply)	2.10 lb (0.95 kg)
Environmental Operating Ranges	
Nonoperating temperature	−4 to 149°F (−20 to 65°C)
Nonoperating humidity	5 to 95% relative humidity
Nonoperating altitude	0 to 15,000 ft (4570 m)
Operating temperature	32 to 104°F (0 to 40°C)
Operating humidity	10 to 85% relative humidity
Operating altitude	0 to 10,000 ft (3000 m)

Table A-1 Router Specifications (continued)

Description	Design Specification
Router Power	
AC input voltage	100 to 240 VAC
Frequency	50 to 60 Hz
Power output	26 W maximum
Output voltages	5 V and 12 V
Integrated 802.11b/g Radio Module	
Radio technology	IEEE 802.11b and 802.11g standard compliant
Operating frequency	2412 to 2484 MHz ISM ¹ band
Modulation schemes	OFDM ² , DQPSK ³ , DBPSK ⁴ , 16 QAM ⁵ , 64 QAM, and CCK ⁶
Number of channels	11 channels for the U.S., 13 channels for Europe, 14 channels for Japan
Data rate	54 Mbps with fallback rates of 48, 36, 24, 18, 12, 9, and 6 Mbps
Media access protocol	CSMA/CA ⁷ with ACK ⁸
Power consumption (typical)	500 mA/3.3V at transmit mode, 320 mA/3.3V at receive mode

1. ISM = Industrial, Scientific, and Medical
2. OFDM = orthogonal frequency-division multiplexing
3. DQPSK = differential quaternary phase shift keying
4. DBPSK = differential binary phase shift keying
5. QAM = quadrature amplitude modulation
6. CCK = complementary code keying
7. CSMA/CA = carrier sense multiple access with collision avoidance
8. ACK = acknowledgement

Power-over-Ethernet Module Specifications

Table A-2 shows the specifications for the power-over-Ethernet (PoE) module.

Table A-2 POE Module Specifications

Description	Design Specification
Physical Dimensions	
Dimensions (H x W x D)	1.13 x 4.0 x 10.25 in. (29 x 102 x 260 mm)
Weight (not including desktop power supply)	0.32 lb (0.14 kg)

Table A-2 POE Module Specifications (continued)

Description	Design Specification
Environmental Operating Ranges	
Nonoperating temperature	–4 to 149°F (–20 to 65°C)
Nonoperating humidity	5 to 95% relative humidity
Nonoperating altitude	0 to 15,000 ft (4570 m)
Operating temperature	32 to 104°F (0 to 40°C)
Operating humidity	10 to 85% relative humidity
Operating altitude	0 to 10,000 ft (3000 m)
Power	
AC input voltage	100 to 240 VAC
Frequency	50 to 60 Hz
Power output	80 W maximum
Output voltage	48 VDC

For information on regulatory compliance, see the *Regulatory Compliance and Safety Information for Cisco 800 Series and SOHO Series Routers* document that was shipped with your router.

**Warning**

Ultimate disposal of this product should be handled according to all national laws and regulations.
Statement 1040

LAN Port Pinouts

Table A-3 provides pinouts for the Ethernet LAN port on the routers.

Table A-3 Ethernet LAN Port Pinouts

Pin	Function
1	RX+
2	RX–
3	TX+
4	Unused
5	Unused
6	TX–
7	Unused
8	Unused

Console Connector Pinouts

Table A-4 provides pinouts for the console connector (for connecting a terminal or PC).

Table A-4 Console Connector Pinouts (RJ-45-to-DB-9)

RJ-45 Pin	Function	DB-9 Pin
1	RTS	8
2	DTR	6
3	TXD	2
4	GND	5
5	GND	5
6	RXD	3
7	DSR	4
8	CTS	7

The console port is configured as a data communications equipment (DCE) device. The default parameters for the console port are as follows:

- 9600 baud
- 8 data bits
- No parity
- One stop bit

ADSL Port Connector Pinouts

Table A-5 shows ADSL connector pinouts.

Table A-5 ADSL Connector Pinouts (RJ-11-to-RJ-45)

RJ-11 Pin	Function	RJ-45 Pin	Function
1	Unused	1	Unused
2	Unused	2	Unused
3	Ring	3	Unused
4	Tip	4	Ring
5	Unused	5	Tip
6	Unused	6	Unused
		7	Unused
		8	Unused

Cable Specifications

This section provides specifications for the following Ethernet cables, which you might need to provide:

- Straight-through cable
- Crossover cable

Because of the autocrossover (autosensing) function, both straight-through and crossover cables can be used for the Ethernet LAN port.

Ethernet Cable Specifications

[Table A-6](#) provides specifications that apply to both straight-through and crossover Ethernet cables.

Table A-6 *Ethernet Cable Specifications*

Type	Category
10BASE-T	Category 3 or 5
100BASE-T	Category 5 or higher

Maximum Cable Length

The maximum length for the Ethernet cables that connect equipment to the router is 328 ft (100 m). The length also indicates the maximum distance between the router and the equipment connected to it.



Numerics

- 100BASE-T [7](#)
- 10BASE-T [7](#)
- 802.11b/g integrated radio module [8,11](#)

A

- AC adapter
 - connecting to router [19](#)
- AC input voltage specifications
 - PoE module [3](#)
 - router [2](#)
- ADSL connector pinouts [4](#)
- ADSL-over-ISDN port
 - connecting [17](#)
 - description [8](#)
- ADSL-over-POTS port
 - connecting [16](#)
 - description [7](#)
- altitude specifications
 - PoE module [3](#)
 - router [1](#)
- antennas
 - connecting to the router [6](#)
 - supported [12](#)
- asymmetric digital subscriber line
 - See* ADSL
- async modem
 - connecting to console port [13](#)
- autosensing feature [8](#)

B

- back panel
 - Cisco 851 [2](#)
 - Cisco 857 [4](#)
 - Cisco 871 [2](#)
 - Cisco 876 [5](#)
 - Cisco 877 [4](#)
 - Cisco 878 [7](#)
 - PoE module [13](#)
- broadband modem
 - connecting to router [11](#)

C

- cables
 - autosensing in router [8](#)
 - maximum length [5](#)
 - specifications (table) [5](#)
- caution, defined [8](#)
- Cisco reseller, contacting [1](#)
- Cisco Router and Security Device Manager [1](#)
- CLI
 - for initial configuration [4](#)
- connecting
 - AC adapter [19](#)
 - ADSL-over-ISDN port [17](#)
 - ADSL-over-POTS port [16](#)
 - async modem to the console port [13](#)
 - broadband modem [11](#)
 - console port to async modem [13](#)
 - external Ethernet switch [9](#)
 - G.SHDSL port [18](#)

ISDN S/T port [14](#)
 nonwireless routers [2](#)
 PC to the console port [12](#)
 power [18](#)
 power-over-Ethernet module [7](#)
 power supply [19](#)
 server, PC, or workstation [8](#)
 to the Internet [11](#)
 console connector pinouts [4](#)
 console port
 connecting
 to an async modem [13](#)
 to a PC [12](#)
 default parameters [4](#)
 description [8](#)
 crossover cable [8](#)

D

damage to the router, preventing [4](#)
 diversity omnidirectional antenna [12](#)
 DSLAM [8](#)
 dying gasp feature [8](#)

E

electrostatic damage, preventing [3](#)
 Ethernet port
 connecting to a PC [8](#)
 description [7](#)
 Ethernet ports
 pinouts [3](#)
 external Ethernet switch
 connecting to router [9](#)

F

Fast Ethernet WAN port

 connecting to the Internet [11](#)
 description [7](#)
 feature summary (table) [7](#)
 flash memory [8](#)
 frequency specifications
 PoE module [3](#)
 router [2](#)
 front panel
 Cisco 851 and Cisco 871 [2](#)
 Cisco 857 and Cisco 877 [3](#)
 Cisco 876 [5](#)
 Cisco 878 [6](#)
 PoE module [13](#)

G

G.SHDSL port
 connecting [18](#)
 description [8](#)

H

hardware security [17](#)
 humidity specifications
 PoE module [3](#)
 router [1](#)

I

initial configuration
 using
 Cisco SDM [1](#)
 CLI [4](#)
 setup command facility [2](#)
 installation
 Cisco 851 or Cisco 871 router example [3](#)
 Cisco 857 or Cisco 877 router example [4](#)
 Cisco 876 router example [5](#)

- Cisco 878 router example [6](#)
- preparing for [5](#)
- integrated 802.11b/g radio module [8, 11](#)
- IPSec hardware accelerator [8](#)
- ISDN S/T port
 - connecting [14](#)
 - description [7](#)
- items shipped with the router [4](#)

K

- Kensington security slot [17](#)

L

- LAN port pinouts [3](#)
- LEDs
 - PoE module [16](#)
 - router [9](#)
 - used in troubleshooting [2](#)
 - verifying router operations [21](#)

M

- manual configuration
 - using the CLI [4](#)
- memory
 - flash [8](#)
 - SDRAM [8](#)
 - summary [16](#)
- modem
 - connecting to router [11](#)
- mounting
 - on a table [1](#)
 - on a wall
 - guidelines [2](#)
 - PoE module [5](#)
 - router [2](#)

- multirate symmetrical high-data-rate digital subscriber line (G.SHDSL) [6](#)

N

- nonwireless routers [2](#)

O

- omnidirectional antenna [12](#)
- output voltage specifications
 - PoE module [3](#)
 - router [2](#)

P

- patch antenna [12](#)
- PC
 - connecting to router [8](#)
- pinouts
 - ADSL connector [4](#)
 - console connector [4](#)
 - LAN port [3](#)
- PoE module. *See* power-over-Ethernet module
- port
 - ADSL-over-ISDN [8](#)
 - ADSL-over-POTS [7](#)
 - console [8](#)
 - Ethernet [7](#)
 - G.SHDSL [8](#)
 - ISDN S/T port [7](#)
- power
 - problems [2](#)
 - specifications
 - PoE module [3](#)
 - router [2](#)
- power-over-Ethernet module
 - connecting [7](#)
 - description [12](#)

specifications [2](#)
 power supply, connecting [19](#)
 preventing damage to the router [4](#)
 problems
 after router is running (table) [3](#)
 during first startup (table) [2](#)

R

regulatory compliance and safety information [17](#)
 Reset button [8](#)
 router models
 Cisco 851 and Cisco 871 [1](#)
 Cisco 857 and Cisco 877 [3](#)
 Cisco 876 [5](#)
 Cisco 878 [6](#)
 router ports
 Cisco 851 and Cisco 871 [3](#)
 Cisco 857 and Cisco 877 [5](#)
 Cisco 876 [6](#)
 Cisco 878 [7](#)
 router specifications [1](#)

S

safety warnings
 general [1](#)
 wireless routers [3](#)
 SDM
 for initial configuration [1](#)
 installing [1](#)
 SDRAM [8](#)
 security
 IPSec hardware accelerator [8](#)
 Kensington lock [17](#)
 software features [8](#)
 serial number location [9](#)
 server

 connecting to router [8](#)
 setup command facility
 for initial configuration [2](#)
 show configuration command [5](#)
 show interfaces command [5](#)
 show ip interface brief command [5](#)
 specifications
 Ethernet cable (table) [5](#)
 PoE module [2](#)
 router [1](#)
 startup problems [2](#)
 straight-through cable [8](#)
 system specifications (table) [1](#)

T

temperature specifications
 PoE module [3](#)
 router [1](#)
 troubleshooting [1 to 4](#)

U

unpacking the router [4](#)
 USB ports
 description [8](#)
 power allocation [3](#)

V

verifying
 initial configuration [5](#)
 router operations [21](#)

W

wall mounting
 PoE [5](#)

- router [2](#)
- warnings
 - general [1](#)
 - wireless routers [3](#)
- weight specifications
 - PoE module [2](#)
 - router [1](#)
- wireless routers
 - description [11](#)
 - supported antennas [12](#)
- workstation
 - connecting to router [8](#)

