

Software version TC6.3  
OCTOBER 2013



Codec C40/C60



Profile 42"



Profile 52"/55"



Profile 52" Dual / 55" Dual



Profile 65"

# Administrator guide

For Cisco TelePresence System Codec C40/C60 and Profiles using C40/C60

Thank you for choosing Cisco!

Your Cisco product has been designed to give you many years of safe, reliable operation.

This part of the product documentation is aimed at administrators working with the setup of the Codec C60/C40 and Profiles using Codec C60/C40.

Our main objective with this Administrator guide is to address your goals and needs. Please let us know how well we succeeded!

May we recommend that you visit the Cisco web site regularly for updated versions of this guide.

The user documentation can be found on  
 ► <http://www.cisco.com/go/telepresence/docs>

### How to use this guide

The top menu bar and the entries in the Table of contents are all hyperlinks. You can click on them to go to the topic.

## Table of Contents

<b>Introduction.....</b>	<b>4</b>	Managing the list of trusted certificate authorities .....	44
User documentation .....	5	Adding audit certificates .....	45
Software .....	5	Setting strong security mode .....	46
What's new in this version .....	6	Changing the persistency mode.....	47
Profile 42" using Codec C40 at a glance .....	8	Deleting trust lists (CUCM only).....	48
Profile 52"/55" at a glance .....	9	Troubleshooting .....	49
Profile 52" Dual / 55" Dual at a glance .....	10	Downloading log files.....	50
Profile 65" at a glance.....	11	Upgrading the system software.....	51
Codec C60 at a glance.....	12	Backup and restore.....	52
Codec C40 at a glance.....	13	System recovery:	
<b>Web interface .....</b>	<b>14</b>	Revert to the previously used software version .....	53
Accessing the web interface .....	15	System recovery: Factory reset.....	54
Changing the system password .....	16	Restarting the system .....	55
The interactive menu .....	17	<b>System settings .....</b>	<b>56</b>
System information.....	18	Overview of the system settings .....	57
Placing a call.....	19	Audio settings .....	60
Sharing content.....	20	Cameras settings.....	66
Controlling and monitoring a call .....	21	Conference settings .....	69
Controlling your camera.....	22	FacilityService settings.....	74
Local layout control.....	23	GPIO settings .....	75
Capturing snapshots.....	24	H323 settings.....	76
Controlling the far end camera .....	25	Logging settings .....	79
Accessing call information.....	26	Network settings.....	80
Managing the favorites list .....	27	NetworkPort settings.....	87
Favorite list folders.....	28	NetworkServices settings.....	88
System configuration .....	29	Phonebook settings.....	93
Changing system settings .....	30	Provisioning settings.....	94
Setting the Administrator Settings menu password .....	31	RTP settings.....	96
System status .....	32	Security settings .....	97
Choosing a wallpaper .....	33	SerialPort settings.....	99
Choosing a ringtone.....	34	SIP settings.....	100
Peripherals overview .....	35	Standby settings .....	104
User administration.....	36	SystemUnit settings.....	105
Adding a sign in banner .....	40	Time settings .....	107
Managing startup scripts .....	41	UserInterface settings.....	108
Application programming interface.....	42	Video settings .....	109
Managing the video system's certificates .....	43	Experimental settings .....	124



- Setting passwords ..... 125**
  - Setting the system password ..... 126
  - Setting the menu password..... 127
  - Setting a root password..... 128
- Appendices..... 129**
  - Cisco VCS provisioning ..... 130
  - About monitors when you have a Codec C60..... 131
  - About monitors when you have a Codec C40..... 132
  - Connecting the Cisco TelePresence Touch 8” controller..... 133
  - Advanced customization of video and audio ..... 134
  - Optimal definition profiles ..... 135
  - ClearPath – Packet loss resilience ..... 136
  - Requirement for speaker systems connected to a  
Cisco TelePresence C Series codec ..... 137
  - DNAM for Profile 42”/52”/55” ..... 138
  - DNAM for Profile 65” ..... 139
  - Factory resetting ..... 140
  - Factory resetting the Touch 8” controller ..... 141
  - Technical specifications..... 142
  - Supported RFCs ..... 150
  - User documentation on the Cisco web site..... 151
- Cisco contacts ..... 152**

# Chapter 1

## Introduction

This document provides you with the information required to administrate your product at an advanced level.

**Products covered in this guide:**

- Profile 52" / 55" / 65" using C60
- Profile 52" Dual / 55" Dual using C60
- Profile 42" / 52" / 55" using C40
- Codec C60
- Codec C40

## User documentation

The user documentation for the Cisco TelePresence Codec C Series has several guides suitable for various user groups.

- **Installation guides:**  
How to install the product
- **Getting started guide:**  
Initial configurations required to get the system up and running
- **Administering TC Endpoints on CUCM:**  
Tasks to perform to start using the product with the Cisco Unified Communications Manager (CUCM)
- **Administrator guide (this guide):**  
Information required to administer your product
- **Quick reference guides:**  
How to use the product (remote control and Touch controller)
- **User guides:**  
How to use the product (remote control and Touch controller)
- **Camera user guide:**  
User guide for the PrecisionHD cameras
- **API reference guide:**  
How to use the Application Programmer Interface (API), and reference guide for the command line commands
- **User guide for the TC console application:**  
The free TC Console application provides a graphical interface to the advanced customizable features of the codec.
- **Physical interface guides**
- **Knowledge base articles**
- **Video conferencing room primer:**  
General guidelines for room design and best practice
- **Video conference room acoustics guidelines:**  
Things to do to improve the perceived audio quality
- **Software release notes**
- **Regulatory compliance and safety information guide**
- **Legal & license information**

### Downloading the user documentation

We recommend you visit the Cisco web site regularly for updated versions of the user documentation.

Go to: ► <http://www.cisco.com/go/telepresence/docs>

Guidelines how to find the documentation on the Cisco web site are included in the ► [User documentation on the Cisco web site](#) appendix.

## Software

You can download the software for your product from the Cisco web site. Go to:

► <http://www.cisco.com/cisco/software/navigator.html>

We recommend reading the Software Release Notes (TC6), go to:

► [http://www.cisco.com/en/US/products/ps11422/tsd\\_products\\_support\\_series\\_home.html](http://www.cisco.com/en/US/products/ps11422/tsd_products_support_series_home.html)

## What's new in this version

This section provides an overview of the new and changed system settings and new features in the TC6.3 software version.

### Software release notes

For a complete overview of the news and changes, we recommend reading the Software Release Notes (TC6).

Go to: ► [http://www.cisco.com/en/US/products/ps11422/tsd\\_products\\_support\\_series\\_home.html](http://www.cisco.com/en/US/products/ps11422/tsd_products_support_series_home.html)

### Software download

For software download go to: ► <http://www.cisco.com/cisco/software/navigator.html>

## New features and improvements

### Support for CUCM Extension Mobility

The Extension Mobility feature allows you to log in to a TelePresence endpoint with your personal credentials. It is well suited for endpoints that will be used by several users. The feature is fully managed from CUCM (Cisco Unified Communication Manager), and no further configuration is required on the endpoint.

When a user logs in, the endpoint adopts the individual user's default device profile information, including line numbers, speed dials, services links, and other user-specific properties of an endpoint. When another user logs in, the settings and properties change to match the new user.

For details on how to setup Extension Mobility, please refer to the *Features and Services guide for CUCM* at ► [http://www.cisco.com/en/US/products/sw/voicesw/ps556/prod\\_maintenance\\_guides\\_list.html](http://www.cisco.com/en/US/products/sw/voicesw/ps556/prod_maintenance_guides_list.html).

### Support for non-persistent mode

As a general rule, we recommend not to change the default settings for persistency. This means that configurations, call history, internal logs, local phonebook / favorites list and IP connectivity information are stored, and a system restart does not delete the information.

In the case were a new user is not supposed to see or trace back to any kind of logged information from the previous session, non-persistent mode may be switched on. In this mode the configurations etc. are stored only in RAM, and will be wiped at every shutdown. The persistency settings can be configured from the *Configuration > Security* page on the web interface.

### Support for new languages on Touch 8

The following new languages are supported on Touch 8: Arabic and Hebrew.

### ICE support on Active control

Active Control (introduced in TC6.2) now has ICE support (Interactive Connectivity Establishment, RFC 5245) when registered to a VCS. This means that ICE and Active Control can be used at the same time in this case.

### Improved quality for presentation sources

An input source is fed directly to the encoder. The resolution is not changed as long as it does not exceed the endpoint's maximum supported resolution and there are no bandwidth restrictions. If the image must be resized to fit a recipient's screen, the scaling is performed after decoding on the far end.

This leads to improved quality for presentation sources that have other resolutions than the traditional video resolutions.

### Automatic echo reference delay detection in high latency environments

Automatic delay detection is introduced for high latency environments; in earlier TC software releases the delay had to be set manually. This makes it easier to configure the echo cancellation correctly when high latency monitors and HDMI audio output are used. This is typically the case for consumer TVs with image processing.

### Call History available in the web interface

The Call History list is available in the web interface (choose *Call Control > Call History* in the navigation bar ). You can use the web interface to delete entries or clear the complete list.

You can download the Call History in an archive together with the log files if you choose *Diagnostics > Log Files* in the web interface navigation bar.

### Extended logging mode for troubleshooting

You can switch on extended logging from the web interface. Extended logging may help diagnose network issues and problems during call setup.

Extended logging uses more of your video system's resources, and may cause the system to underperform. Therefore extended logging should be enabled just to reproduce an issue, and then disabled.

### Other Web interface enhancements

- Call state indication available from the top bar on all pages in the web interface.
- Far end camera control.

### System configuration changes

#### New configurations

NetworkServices WelcomeText: <Off/On>  
 Provisioning ExternalManager AlternateAddress: <S: 0, 64>  
 Security Audit Server PortAssignment: <Auto/Manual>  
 SIP Profile Ice Mode: <Auto/Off/On>  
     Replacing SIP Profile Ice  
 SIP Profile Ice DefaultCandidate: <Host/Rflx/Relay>  
     Replacing SIP Profile IceDefaultCandidate  
 SIP Profile Turn DiscoverMode: <Off/On>  
 SIP Profile Turn DropRflx: <Off/On>  
 SIP ANAT: <Off/On>  
 SIP PreferredIPMedia: <IPv4/IPv6>  
 SIP PreferredIPSignaling: <IPv4/IPv6>  
 Video Layout Engine LocalMode: <Disabled/Enabled/DisabledPIPs>  
 Video Layout PresentationDefault View: <Default/Minimized/Maximized>  
 Video Layout DisableDisconnectedLocalOutputs: <Off/On>  
 Video OSD CallSettingsSelection: <Off/On>

#### Configurations that are removed

Cameras PowerLine Frequency  
 Conference PacketLossResilience Mode  
 Conference LyncCompatibility  
 SIP Profile Ice  
     Replaced by SIP Profile Ice Mode  
 SIP Profile IceDefaultCandidate  
     Replaced by SIP Profile Ice DefaultCandidate

### Configurations that are modified

Conference DefaultCall Protocol  
     **OLD:** <H323/Sip/H320>  
     **NEW:** <Auto/H323/Sip/H320>  
 Conference CallProtocolIPStack  
     **OLD:** <IPv4/IPv6>  
     **NEW:** <Dual/IPv4/IPv6>  
 SIP Profile Type  
     **OLD:** <Standard/Alcatel/Avaya/Cisco/Microsoft/Nortel>  
     **NEW:** <Standard/Cisco>  
 SIP Profile Ice Mode  
     **OLD:** <Off/On>  
     **NEW:** <Auto/Off/On>  
 SystemUnit MenuLanguage  
     **OLD:** <English/ChineseSimplified/ChineseTraditional/Czech/Danish/Dutch/Finnish/French/German/Hungarian/Italian/Japanese/Korean/Norwegian/Polish/PortugueseBrazilian/Russian/Spanish/SpanishLatin/Swedish/Turkish>  
     **NEW:** <English/ChineseSimplified/ChineseTraditional/Catalan/Czech/Danish/Dutch/Finnish/French/German/Hungarian/Italian/Japanese/Korean/Norwegian/Polish/PortugueseBrazilian/Russian/Spanish/SpanishLatin/Swedish/Turkish/Arabic/Hebrew>  
 Video OSD Output[n]  
     **OLD:** <1/2>  
     **NEW:** <Auto/1/2>  
 Video Output HDMI[n] MonitorRole  
     **OLD:** <First/Second/PresentationOnly/Recorder>  
     **NEW:** <Auto/First/Second/PresentationOnly/Recorder>  
 Video Output DVI[n] MonitorRole  
     **OLD:** <First/Second/PresentationOnly/Recorder>  
     **NEW:** <Auto/First/Second/PresentationOnly/Recorder>  
 Video Output Composite[n] MonitorRole *(only C60)*  
     **OLD:** <First/Second/PresentationOnly/Recorder>  
     **NEW:** <Auto/First/Second/PresentationOnly/Recorder>

## Profile 42" using Codec C40 at a glance

See the installation sheet for the Profile 42" for instructions on how to install the system.

### Codec C40

- Full HD video
- High resolution data sharing
- Full HD Multisite
- Rich I/O capabilities

### PrecisionHD 1080p camera

Full HD Camera designed for visual communication with:

- 12 × optical zoom
- Fast and precise pan, tilt and zoom

### Monitor

42" Full HD LCD, 16:9, 1080 × 1920 resolution

### Audio module

Wide band audio module supporting:

- 20 kHz AAC-LD
- Full echo canceling
- Stereo

### Audio amplifier

Optimized DNAM for the Profile system, providing crystal clear and natural audio

### Microphones

2 × Microphones

### Operating devices

- Touch 8" controller (for C Series)
- Remote control with AAA batteries

### Base options

Floor standing footplate, wheel base, or wall mount on pedestal





## Profile 52"/55" at a glance

See the installation sheets for the Profile 52"/55" for instructions on how to install the system.

### Codec C60/C40

- Full HD video
- High resolution data sharing
- Full HD Multisite
- Rich I/O capabilities

### PrecisionHD 1080p camera

Full HD Camera designed for visual communication with:

- 12 x optical zoom
- Fast and precise pan, tilt and zoom

### Monitor

52"/55" Full HD LCD, 16:9, 1080 x 1920 resolution

### Audio module

Wide band audio module supporting:

- 20 kHz AAC-LD
- Full echo canceling
- Stereo

### Audio amplifier

Optimized DNAM for the Profile system, providing crystal clear and natural audio

### Microphones

Three (with C60) / Two (with C40) microphones with cables

### Operating devices

- Touch 8" controller
- Remote control with AAA batteries

### Base options

Floor standing footplate, wheel base, or wall mount on pedestal



## Profile 52" Dual / 55" Dual at a glance

See the installation sheets for the Profile 52" Dual / 55" Dual for instructions on how to install the system.

### Codec C60

- Full HD video
- High resolution data sharing
- Full HD Multisite
- Rich I/O capabilities

### PrecisionHD 1080p camera

Full HD Camera designed for visual communication with:

- 12 × optical zoom
- Fast and precise pan, tilt and zoom

### Dual monitor

Dual 52" / Dual 55" Full HD LCD, 16:9, 1080 × 1920 resolution

### Audio module

Wide band audio module supporting:

- 20 kHz AAC-LD
- Full echo canceling
- Stereo

### Audio amplifier

Optimized DNAM for the Profile system, providing crystal clear and natural audio

### Microphones

Four microphones with cables

### Operating devices

- Touch 8" controller
- Remote control with AAA batteries

### Base options

Floor standing footplate or wall mount on pedestal

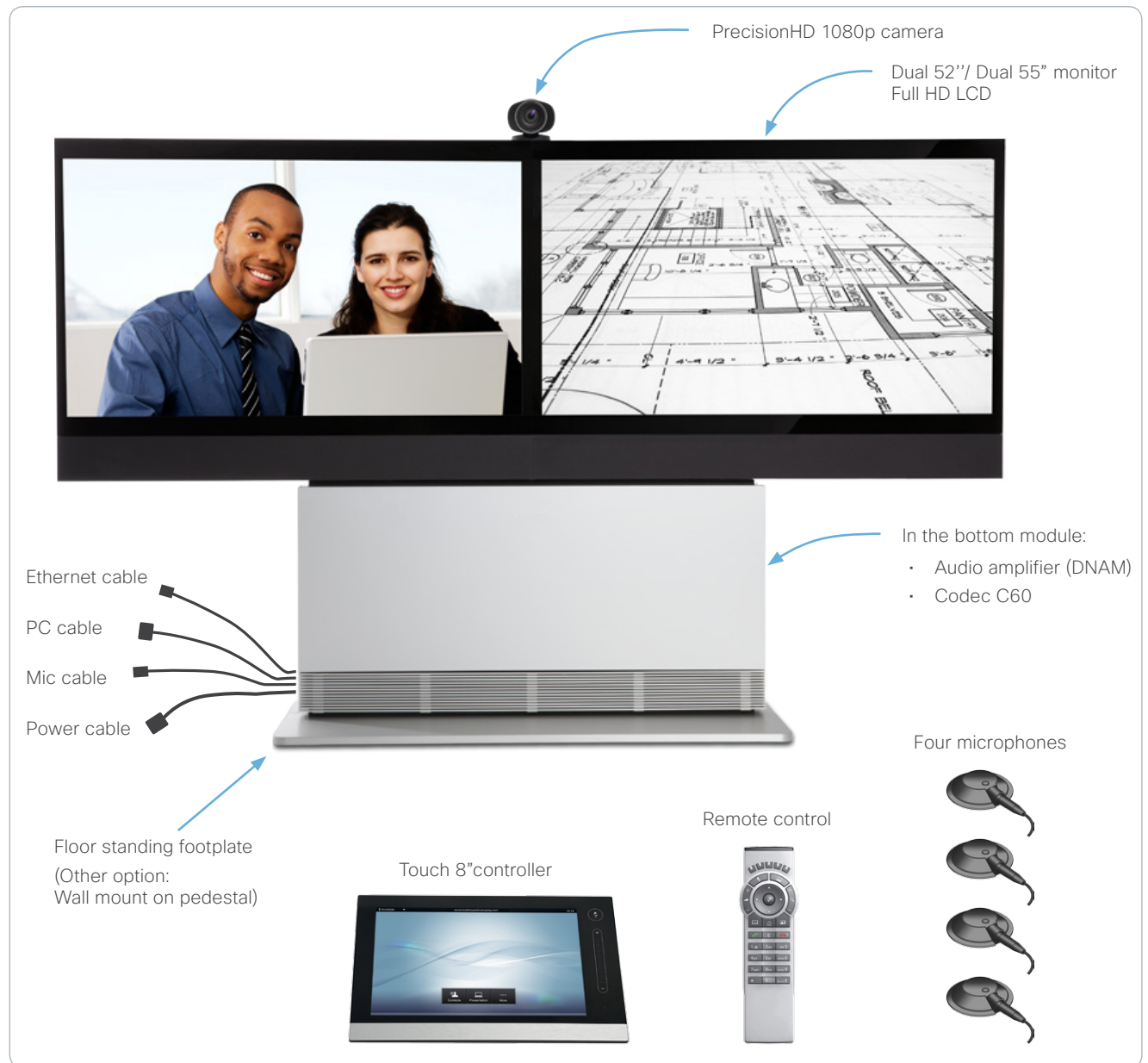

## Profile 65" at a glance

See the Profile 65" Installation Sheet for instructions of how to assemble the system.

### Codec C60

- Full HD video
- High resolution data sharing
- Full HD Multisite
- Rich I/O capabilities

### PrecisionHD 1080p camera

Full HD Camera designed for Visual communication with:

- 12 × optical zoom
- Fast and precise pan, tilt and zoom

### Monitor 65"

65" Full HD LCD, 16:9, 1080 × 1920 resolution

### Audio module

Wide band audio module supporting:

- 20 kHz AAC-LD
- Full echo canceling
- Stereo

### Audio amplifier

Optimized DNAM for the Profile system, providing crystal clear and natural audio

### Microphones

Three microphones with cables

### Operating devices

- Touch 8" controller
- Remote control with AAA batteries

### Base options

Floor standing footplate or wall mount on pedestal



## Codec C60 at a glance

The Codec C60 is the 1080p HD video collaboration engine. Based upon the same technology as the Codec C90, the C60 delivers Full HD video, HD collaboration and superior audio for natural communication at its finest, delivering unrivaled value.

The C60 is a standards-compliant codec for integration into team meeting rooms, boardrooms and industry projects.

- Full High Definition Video with up to 4 HD sources, and collaboration with optimal definition for the best video quality every time, regardless of environment.
- Highest Quality Audio with flexibility to add up to 4 microphones directly from the codec, and superior, full duplex audio with high quality stereo sound.
- Full APIs.
- Ensure successful, streamlined integration projects with standards-compliant professional connectors.

## Integrator package

The integrator package of the Codec C60 comes with the PrecisionHD 1080p camera, microphone and cables.



## Codec C40 at a glance

The Codec C40 provides all the power required to transform any conference room to a HD video collaboration room. Designed for any standard HD integration project, the Codec C40 is the ideal solution for everyday video conferencing and collaboration solution. 1080p HD video, and Multisite™ features combine to make the Codec C40 ideal for a variety of applications.

The Codec C40 is ideal for standard meeting rooms, executive offices and team collaboration rooms.

- Full High Definition Video with up to 2 HD sources, and collaboration with optimal definition for the best video quality every time, regardless of environment.
- Highest Quality Audio with flexibility to add up to 2 microphones directly from the codec, and superior, full duplex audio with high quality stereo sound.
- Full APIs.
- Ensure successful, streamlined integration projects with standards-compliant professional connectors.

## Integrator package

The integrator package of the Codec C40 comes with the PrecisionHD 1080p camera, microphone and cables.



## Chapter 2

# Web interface

## Accessing the web interface

The web interface provides full configuration access to your video conference system.

You can connect from a computer and administer the system remotely.

In this chapter you will find information how to use the web interface for system configuration and maintenance.

We recommend that you use the latest release of one of the major web browsers.

### 1. Connect to the video system

Open a web browser and enter the IP address of the video system in the address bar.



To find the IP address (IPv4 or IPv6), tap *Settings* (✖) on a Touch controller; or navigate to *Home > Settings > System information* when using a remote control and the on-screen menu.

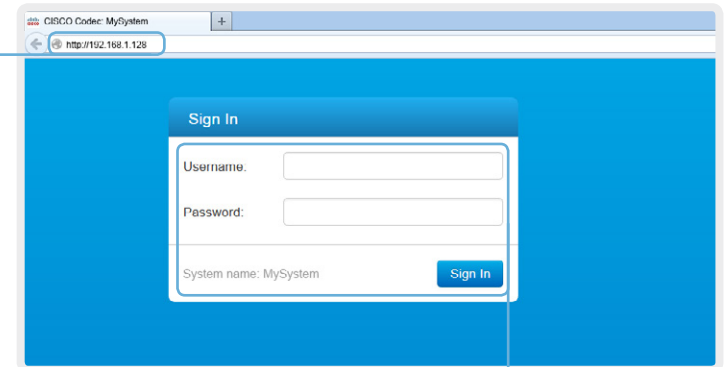

### 2. Sign in

Enter the user name and password for your video system and click *Sign In*.



The system is delivered with a default user named *admin* with no password (i.e. leave the *Password* field blank when signing in for the first time).

We strongly recommend that you set a password for the *admin* user, see the next page.

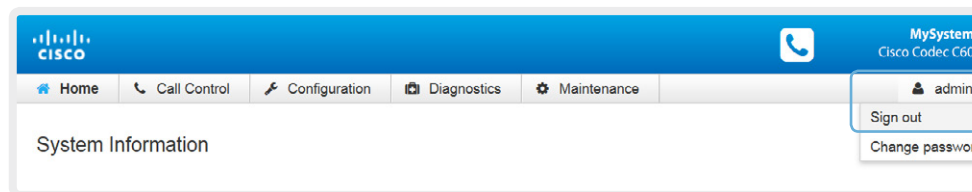

### Signing out

Hover the mouse over your user name and choose *Sign out* from the drop-down list.

## Changing the system password



We strongly recommend that you set a password for any user with ADMIN rights in order to restrict access to system configuration. This includes the default *admin* user.

A warning, saying that the system password is not set, is shown on screen until you set a password.

You can read more about password protection in the [▶ Setting passwords](#) chapter.

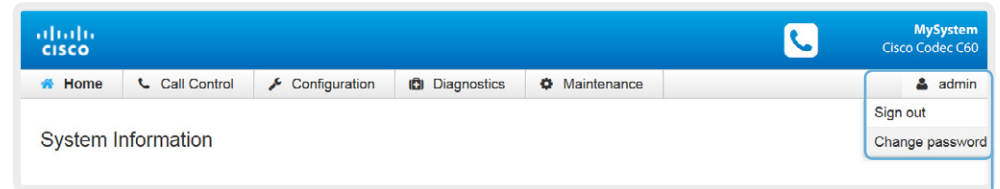

### 1. Open the Change Password dialog

Hover the mouse over your user name, and choose [Change password](#) in the drop-down list.

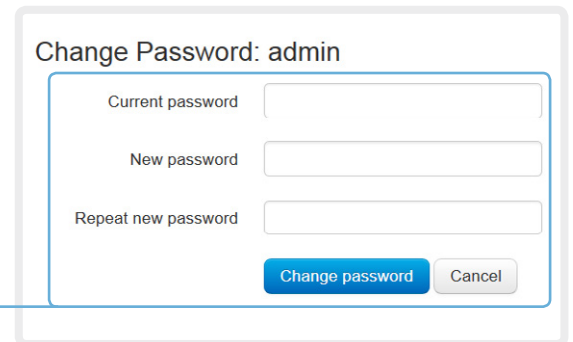

### 2. Set the new password

Enter your current and new passwords as requested, and click [Change password](#) for the change to take effect.



If the password currently is not set, leave the *Current password* field blank.



## The interactive menu

The web interface provides access to tasks and configurations. They are available from the main menu, which appears near the top of the page when you have signed in.

When you hover the mouse over an item in the main menu, you can navigate to its related sub-pages.

### Main menu

Hover the mouse over a main menu item in order to see the titles of the related sub-pages.

Click a sub-page's title to open it. Only pages that the user has access rights for are shown\*.

Click [Home](#) on the main menu to return to the System Information page.

### Sub-pages

Call Control
Call Control
Call History
Favorites Management

Configuration
System Configuration
System Status
Personalization
Peripherals
User Administration
Sign In Banner
Startup Scripts
API
Security

Diagnostics
Troubleshooting
Log Files

Maintenance
Software Upgrade
Backup and Restore
System Recovery
Restart

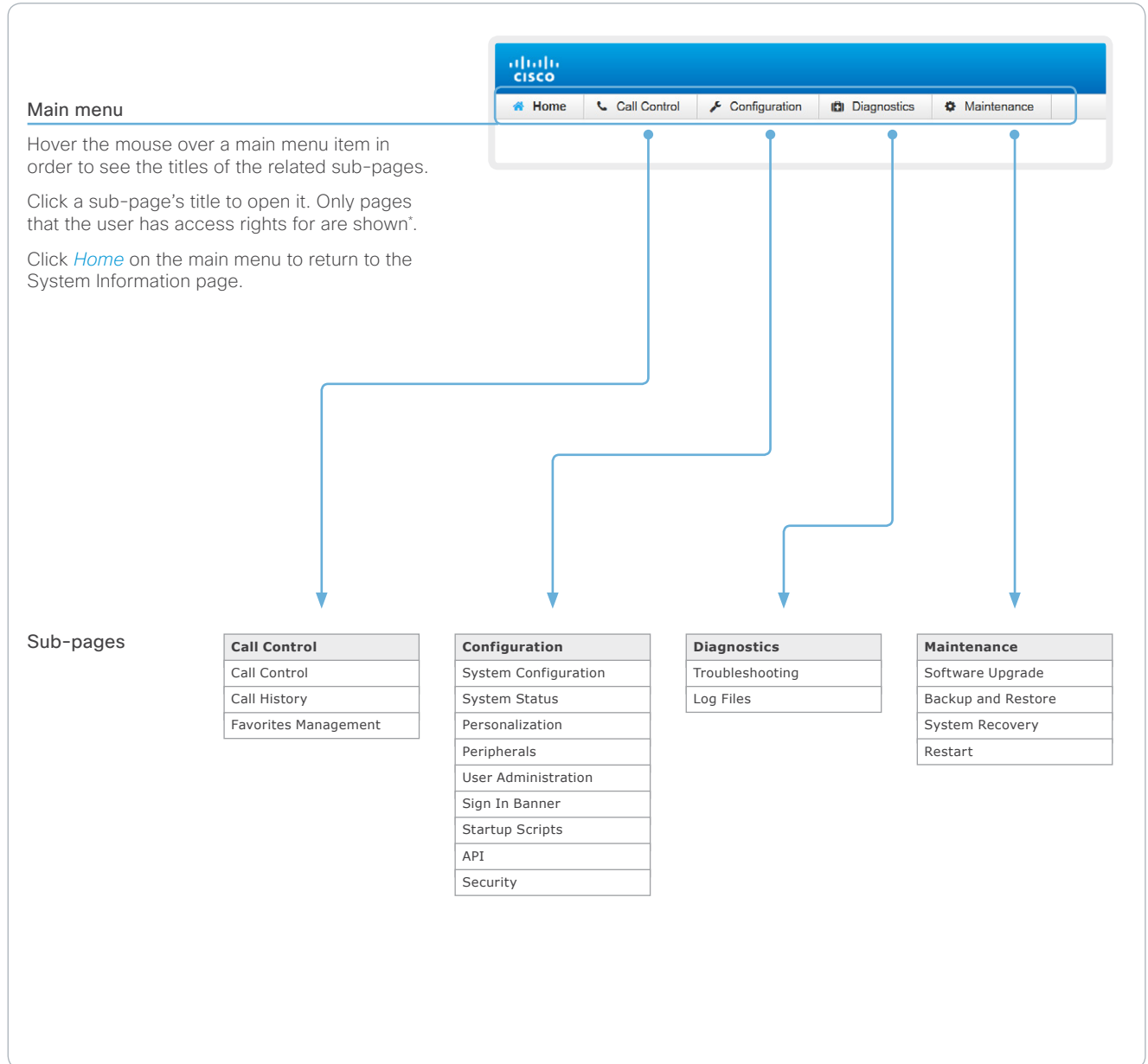

\* You can read more about user administration, user roles and access rights in the [User administration](#) section.

## System information

The video system's Home page shows an overview of the basic set-up and status of the system\*.

This includes information like system name and product type, which software version the system runs, its IP address, etc. Also the registration status for the video networks (SIP and H.323) is included, as well as the number/URI to use when making a call to the system.

Home

### System Information

General	H323
Product: Cisco Codec C60	Status: Registered
Serial number: ABCD12345678	Gatekeeper: 192.168.1.1
Software version: TC6.3.0	Number: 123456
Installed options: PremiumResolution	ID: firstname.lastname@company.com
System name: MySystem	<b>SIP</b>
IPv4 address: 192.168.1.128	Status: Registered
IPv6 address: 2001:DB8:1001:2002:3003:4004:5005:F00F	Proxy: 192.168.1.2
MAC address: 01:23:45:67:89:AB	URI: firstname.lastname@company.com
Temperature: 58.5°C / 137.3°F	

\* The system information shown in the illustration serve as an example. Your system may be different.

## Placing a call

You can use the Call Control page to place a call.

**i** Even if the web interface is used to initiate the call, it is the video system (display, microphones and loudspeakers) that is used for the call; it is not the PC running the web interface.

## Calling

You can call someone either by choosing a contact name in the *Favorites*, *Directory* or *History* lists, or by typing a complete URI or number in the *Search* or *Dial* field. Then click *Call* in the associated contact card.

## Searching the contact lists

Enter one or more characters in the *Search* or *Dial* field. Matching entries from the *Favorites*, *Directory* and *History* lists will be listed as you type.

Select the correct entry in the list before you click *Call*.

## Calling more than one

A point-to-point video call (a call involving two parties only) may be expanded to include more participants.

If your system supports the optional built-in MultiSite feature, up to four participants, yourself included, can join the video call (conference).

One additional participant can join on audio-only.

Follow the same procedure to call the next conference participant as you did when calling the first participant.

Navigate to: Call Control > Call Control

### Call Control

**Main Source** Main camera



Presets...

**Presentation Source** PC



Start Presentation

**Contacts**

Search or Dial x

**Favorites** | Directory | History

Meeting Rooms

Sales and Support Offices

Andrea Carter

**Calling someone**

Click a contact name, either in the *Favorites*, *Directory* or *History* lists. Then click *Call* in the contact card.

Alternatively, enter the complete URI or number in the *Search and Dial* field. Then click the *Call* button that appears next to the URI or number.

**Participants**

Change Layout End All



participant@company.com

participant@company.com

Info Pause End

**Holding and resuming**

Use the Pause button next to the participant's name to put him on hold.

To resume the call, use the Play button that is present when a participant is on hold.

**Ending a call**

If you want to terminate a call or conference, click *End All*. Confirm your choice in the dialog that appears.

To disconnect just one participant in a conference, click the End button for that participant.

## Sharing content

You can connect a presentation source to one of the external inputs of your video system. Most often a PC is used as presentation source, but other options may be available depending on your system setup.

While in a call you can share content with the far end, that is the other participant(s) in the call.

If you are not in a call, the content is shared locally on your display.

Navigate to: Call Control > Call Control

The screenshot displays the Call Control interface with the following components:

- Call Control Header:** Includes microphone status (On), signal strength, and volume controls.
- Main Source:** A video window labeled 'Main camera' showing three participants in a meeting room. Below the video are refresh and mute icons, and a 'Presets...' button.
- Presentation Source:** A window labeled 'PC' showing a slide with the Cisco logo and the text 'Cisco TelePresence Systems'. A 'Start Presentation' button is located at the bottom right.
- Contacts Panel:** Features a search/dial field, tabs for 'Favorites', 'Directory', and 'History', and a list of contacts including 'Meeting Rooms', 'Sales and Support Offices', and 'Andrea Carter'.
- Participants Panel:** Includes a 'Change Layout' button, an 'End All' button, and a list of active participants with their names and email addresses (e.g., 'participant@company.com') and control icons (info, mute, end call).

**Sharing content**

1. Choose a Presentation source from the drop-down list.
2. Click *Start Presentation*.

**Stop content sharing:**  
Click the *Stop Presentation* button that is present while sharing.

## Controlling and monitoring a call

You can control and monitor several call features using the Call Control page.

Navigate to: Call Control > Call Control

Volume down
Volume up

**Microphone mute**

Click the button to mute the microphone. Then the text changes to *Microphone: Off*. Click again to unmute.

**Show/hide call details**

Click the information button to show details about the call. Click the button again to hide the information.

**Call details**

If necessary, scroll your browser to see the call details.

## Controlling your camera

You can control the camera from the Call Control page.

The camera controls (pan, tilt, zoom) are available when the cursor is placed in the Main Source video area. Live snapshots are automatically taken during this period.

Note that the camera controls are not available if the system is in standby mode.

Navigate to: Call Control > Call Control

### Call Control

Main Source
Main camera ▼

**Choose which camera to control**

Click the arrow to open the drop-down list. Then choose the camera you want to control.

**Zoom**

Use + and - to zoom in and out.

**Pan and tilt**

Use the left and right arrows to pan the camera, and the up and down arrows to tilt it.

**Apply preset**

OVERVIEW

WHITEBOARD

Ok

**Camera presets**

If a camera preset is defined it is listed here. Click the preset's name to move the camera(s) to the preset position.

Click **OK** to close the window.

## Local layout control

You can choose a local layout using the Call Control page.

The term layout is used to describe the various ways the videos from the conference participants and a presentation can appear on your screen. Different types of meetings will require different layouts.

Navigate to: Call Control > Call Control

### Call Control

Main Source Main camera

Presets...

Contacts

Search or Dial  ✕

Participants

☰ Change Layout

### Change Layout

Auto

Equal

Prominent

Overlay

Single

**Change the layout**

Click [Change Layout](#), and choose your preferred layout in the window that opens.

You may change the layout while in a call.

## Capturing snapshots

The snapshot feature, which is disabled by default, allows snapshots captured by your video system to be displayed on the Call Control page. Captures from your video system's camera as well as from its presentation channel will be displayed.

This feature might come in handy when administering the video system from a remote location, e.g. to check the camera view.

To use web snapshots you have to sign in with ADMIN credentials.

### Enabling the snapshot feature

The snapshot feature is disabled by default. The feature must be enabled using the remote control and on screen menu, or the Touch controller. The Touch controller must be directly connected to the codec's second Ethernet port.

- Touch controller: Tap *Settings* (✕) > *Administrator Settings* > *Web Snapshots* and choose **On**.
- Remote control and on screen menu: Go to the Advanced configuration menu, navigate to *Video* > *AllowWebSnapshots* and choose **On**.

### Far end snapshots while in a call

While in a call, snapshots of the remote participant's main camera and presentation channel (far end) will be captured and displayed as shown in the illustration. The snapshots are updated approximately every 30 seconds.



Far end snapshots are captured even if web snapshots are disallowed on the far end video system. Web snapshots are prohibited only for encrypted calls.

Navigate to: Call Control > Call Control

The screenshot shows the 'Call Control' interface. At the top, there are status indicators for 'Microphone: On' and a volume control slider. Below this, there are two main video windows: 'Main Source' (Main camera) showing a meeting room with three people, and 'Presentation Source' (PC) showing a 'Cisco TelePresence Systems' slide. Below the video windows are controls for 'Presets...' and 'Start Presentation'. At the bottom, there are two panels: 'Contacts' with a search bar and tabs for 'Favorites', 'Directory', and 'History'; and 'Participants' with a 'Change Layout' button, 'End All' button, and a list of participants with a small thumbnail and controls. A blue box labeled 'Take live snapshots' is overlaid on the interface, with lines pointing to the 'Main Source' and 'Presentation Source' windows. Another blue box labeled 'Far end snapshots' is overlaid on the 'Participants' panel, with a line pointing to a small thumbnail of a participant's video feed.

**Take live snapshots**

While the *Live snapshots* box is checked, snapshots are captured by your video system (main source and presentation source) approximately every two seconds.

**Far end snapshots**

Click the snapshot in order to see a larger image.

**Snapshots from your video system**



## Controlling the far end camera

While in a call, you can control the remote participant's camera (far end) provided that:

- The *Conference FarEndControl Mode* setting is switched **On** on the far end video system.
- The far end camera has pan, tilt or zoom functionality. Only the relevant controls will appear.

Navigate to: Call Control > Call Control

**Call Control**

Main Source: Main camera

Far end camera control indicator

If this symbol is present, you can control the remote participant's camera.

**Control the remote participant's camera**

1. Click the snapshot to show it in a larger window.
2. Place the cursor in the image to enable the controls.
3. Use the left and right arrows to pan the camera; the up and down arrows to tilt it; and + and - to zoom in and out.

## Accessing call information

When administering a video system remotely, it may prove useful to know whether the system is in a call or not, and to be notified when someone places a call to the system.

You can gain this information from the [Call Control](#) page as described in the previous pages, or you can use the [Call state](#) button, which is available on any other page.

The screenshot shows the Cisco TelePresence System web interface. At the top, there is a navigation bar with the Cisco logo and several menu items: Home, Call Control, Configuration, Diagnostics, and Maintenance. On the right side of the navigation bar, there is a 'Call state' indicator, which is a blue telephone handset icon with a small white badge containing the number '1'. A blue arrow points from this indicator to a 'Call Information' dialog box that is open. The dialog box contains a small video thumbnail, the email address 'participant@company.com', and three control buttons: 'i' (info), '||' (hold), and a red handset icon (end call). Below these buttons are two checkboxes: 'Ignore incoming call notices' (unchecked) and 'Open Call Control' (checked). A blue arrow points from the 'Open Call Control' button to the 'Call control' section on the right. Another blue arrow points from the 'Call state' indicator to the 'Call state' section on the right.

**Call state**

The call state indicator is available on all pages except the [Call Control](#) page.

The badge indicates the number of active calls. If the system is idle, there is no badge.

Click the indicator to get more details about connected calls.

**Call control**

Use these buttons to:

- Show call details
- Put the call on hold
- Disconnect the call

**Incoming call notification**

As default, a notification is given when the system receives a call.

Check this box, if you do not want to receive such notifications.

**Opening the Call Control page**

Click [Open Call Control](#) to go straight to the [Call Control](#) page.

## Managing the favorites list

The entries in the favorites list can be accessed from the Touch controller, the on-screen menu (the My contacts folder in the phone book) and the Web interface.

Navigate to: Call Control > Favorites Management

**Favorites Management**

Search contacts  ✕ + Add folder + Add contact

← Back Favorites

Name <span style="font-size: small;">▼</span>	Number
Andrea Carter	
Carlos Jimenez	
Maria Bartelli	
<span style="font-size: small;">Meeting Rooms</span>	
<span style="font-size: small;">Sales and Support Offices</span>	

Cancel Save

**Name**

**Title**

**Folder**

No folder
▼

**Contact method** ✕

Number:

Protocol: Auto ▼

Call rate: Use default ▼

Device:  ▼

+ Add contact method

**Adding a contact**

Click [Add contact](#) and fill in the form that pops up. Then click [Save](#) to store the contact in the favorites list.

**Editing contact details**

Click a contacts name followed by [Edit contact](#). Change the details in the form as appropriate and click [Save](#).

**Deleting a contact**

Click a contacts name followed by [Edit contact](#). Then click [Delete](#) to remove the entry from the favorites list.

**Storing a contact in a folder**

Choose the appropriate folder from the drop down list. No folder means that the contact will be stored at the top level.

**Adding a contact method\***

You can store more than one contact method for each contact, e.g. video, telephone and mobile.

\* Note that only the first contact method will appear in the Favorites list on the Cisco TelePresence Touch controller. All contact methods are available when using the remote control.

## Favorite list folders

The entries in the favorites list can be organized in folders.

Navigate to: Call Control > Favorites Management

**Adding a folder**

Click *Add folder* and fill in the form that pops up. Then click *Save* to create the folder.

**Opening a folder**

Click the folder name to open the folder and show its list of contacts.

**Changing or Deleting a folder**

Click *Edit folder* and update the information in the form that pops up. Then click *Save* to store the changes

Click *Delete* to remove the folder and all its contacts and sub-folders. Confirm your choice in the dialog that pops up.

Name	Number
Berlin Sales Office	berlin@company.com
Buenos Aires Training Center	buenosaires@company.com
Cairo Sales Office	cairo@company.com
Osaka Sales Office	osaka@company.com

## System configuration

The system settings are grouped in several categories. When you choose a category in the left pane all related settings appear to the right\*.

Each system setting is further described in the [System settings](#) chapter.

Navigate to: Configuration > System Configuration

**Searching for settings**

Enter as many letters as needed in the search field.  
All settings (value space included) containing these letters will be highlighted.

### System Configuration

- Audio
- Cameras
- Conference
- Experimental
- FacilityService
- GPIO
- H323
- Logging
- Network
- NetworkPort
- NetworkServices
- Phonebook Server
- Provisioning
- RTP Ports Range
- Security
- SerialPort
- SIP
- Standby
- System Unit

### Conference 1

[Refresh](#)
[^ Collapse all](#)
[v Expand all](#)

Set Administrator Settings menu password.

CallProtocolIPStack	Dual	v	Save
Encryption Mode	BestEffort	v	Save
IncomingMultisiteCall Mode	Allow	v	Save
LyncCompatibility Mode	Off	v	Save
MaxReceiveCallRate	6000	Save	(64 to 6000)
MaxTotalReceiveCallRate	10000	Save	(64 to 10000)
MaxTotalTransmitCallRate	10000	Save	(64 to 10000)
MaxTransmitCallRate	6000	Save	(64 to 6000)
MicUnmuteOnDisconnect Mode	On	v	Save
Multipoint Mode	Auto	v	Save

#### AutoAnswer

Delay	0	Save	(0 to 50)
Mode	On	v	Save

**Selecting a category**

The system settings are structured in categories. Choose a category in order to display the related settings.

**Expanding and collapsing lists**

Use these buttons to expand and collapse all or individual lists.

\* The configuration shown in the illustration serve as an example. Your system may be configured differently.

## Changing system settings

All system settings can be changed from the System Configuration page\*. The value space for a setting is specified either in a drop-down list or by text following the input field.

Different settings may require different user credentials. In order to be sure that an administrator is able to change all system settings, the user must possess all user roles.

You can read more about user administration and user roles in the [User administration](#) chapter.

Navigate to: Configuration > System Configuration

### System Configuration

Conference 1

Set Administrator Settings menu password.

Refresh Collapse all Expand all

Search...

- Audio
- Cameras
- Conference
- Experimental
- FacilityService
- GPIO
- H323
- Logging
- Network
- NetworkPort
- NetworkServices
- Phonebook Server

CallProtocolIPStack	IPv4	Save	
Encryption Mode	BestEffort	Save	
IncomingMultisiteCall Mode	Off	Save	
LyncCompatibility Mode	Off	Save	
MaxReceiveCallRate	6000	Save	(64 to 6000)
MaxTotalReceiveCallRate	10000	Save	(64 to 10000)
MaxTotalTransmitCallRate	9000	Save	(64 to 10000)
MaxTransmitCallRate	6000	Save	(64 to 6000)

**Drop-down list**

Click the arrow to open the drop-down list. Choose the preferred value and click [Save](#) for the change to take effect.

**Text input field**

Enter text in the input field and click [Save](#) for the change to take effect.

\* The configuration shown in the illustration serve as an example. Your system may be configured differently.

## Setting the Administrator Settings menu password

When starting up the video conference system for the first time anyone can access the Administrator Settings menu with either the remote control or the Touch controller because the menu password is not set.



We strongly recommend that you define a menu password, because the Administrator Settings may severely affect the behavior of the video conference system.

You can read more about password protection in the [Setting passwords](#) chapter.

Navigate to: Configuration > System Configuration

**System Configuration**

Search... **Conference 1**

[Set Administrator Settings menu password.](#)

**Changing the menu password**

Click [Set/Change Administrator Settings menu password](#) to open this dialog.

Enter the new password in the text input field and click [Set](#) to set it.

Click [Set](#) without entering a password to leave the Administrator menu unprotected (not recommended).

**Set Administrator Settings menu password** ✕

By specifying an advanced menu password, users will be prompted for a password when trying to enter the advanced settings via an end-point's user interface. Providing an empty password disables the advanced settings password check.

## System status

The system status is grouped in several categories. When you choose a category in the left column, the related status appears in the window to the right\*.

Navigate to: Configuration > System Status

**Searching for status entries**

Enter as many letters as needed in the search field.  
All entries (value space included) containing these letters will be highlighted.

**System Status**

Search...

- Audio
- Camera
- Conference
- Diagnostics
- Experimental
- GPIO
- H320 Gateway
- H323 Gatekeeper
- HttpFeedback
- ICE

**Conference** Refresh Collapse all Expand all

DoNotDisturb		Inactive	^
LoudestSite			
Multipoint Mode		Off	
SelectedCallProtocol		SIP	

**ActiveSpeaker** ^

Mode		Auto	
SiteId		0	

**Selecting a category**

The system status is structured in categories. Choose a category in order to display the related status information.

**Expanding and collapsing lists**

Use these buttons to expand and collapse all or individual lists.

\* The status shown in the illustration serve as an example. The status of your system may be different.



## Choosing a wallpaper

You can choose from a set of predefined wallpapers to use as background on your display.

If you want the company logo or another custom picture as background on the main display, you may upload and use a custom wallpaper.

If you use the Touch controller: The custom wallpaper applies to only the main display and will not appear on the Touch controller.

Navigate to: Configuration > Personalization : Wallpaper tab

### Personalization

Wallpaper
Ringtone

---

**Select active wallpaper**



None

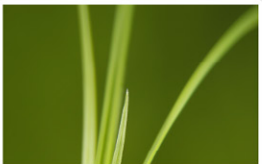

Growing



Summersky

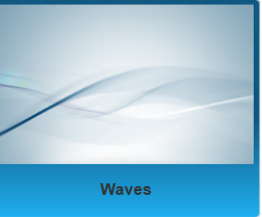

Waves



Custom

---

**Upload custom wallpaper**

Only .png files with a maximum resolution of 1920x1200 are supported.

**Uploading a custom wallpaper file**

Click [Browse...](#) and locate your custom wallpaper image file.

The file format must be .png and the maximum image size is 1920 × 1200 pixels.

Click [Upload](#) to save the file on the video system.

**Choosing a wallpaper**

Choose a wallpaper from the list.

If you have uploaded a custom wallpaper, it will appear in the list together with the predefined wallpapers.

The chosen wallpaper is highlighted.

## Choosing a ringtone

You can choose from a set of predefined ringtones. The chosen ringtone can be played back from this page.

 Even if the web interface is used to initiate the playback it is the video system that plays back the ringtone; it is not the PC running the web interface.

Navigate to: Configuration > Personalization : Ringtone tab

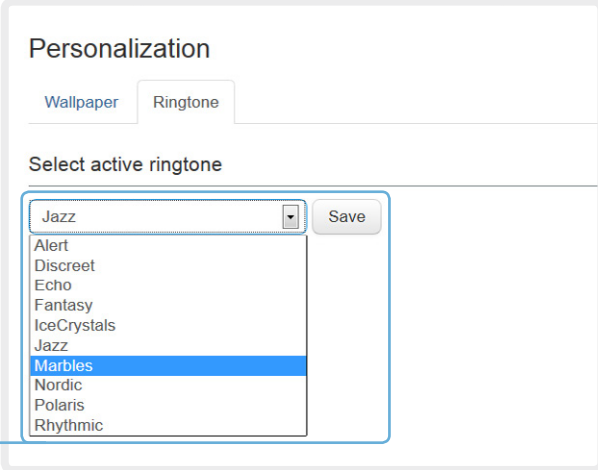

**Personalization**

Wallpaper Ringtone

Select active ringtone

Jazz [v] Save

- Alert
- Discreet
- Echo
- Fantasy
- IceCrystals
- Jazz
- Marbles**
- Nordic
- Polaris
- Rhythmic

### Choosing a ringtone

Choose a ringtone from the drop-down list, and click [Save](#) to make it the active ringtone.

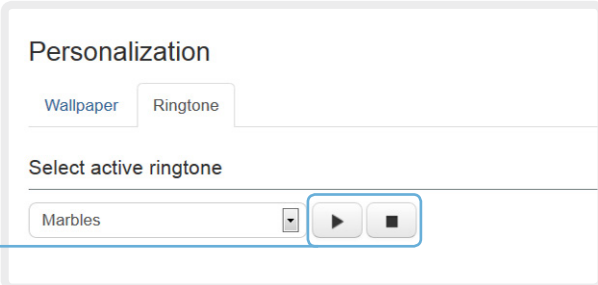

**Personalization**

Wallpaper Ringtone

Select active ringtone

Marbles [v] [▶] [■]

### Playing back a ringtone

Click the play button (▶) to play back the ringtone.

Use the stop button (■) to end the playback.

 You must save the ringtone before it can be played back.

## Peripherals overview

This page shows an overview of the video inputs and outputs, and the devices that are connected to the video system, for example camera(s), microphone(s), a Touch controller or ISDN Link\*.

Navigate to: Configuration > Peripherals

### Peripherals

**Cameras**

⋮

**Video Inputs**

⋮

**Video Outputs**

⋮

**Microphones**

⋮

**ISDN Link**

⋮

Manage ISDN Link

**Touch Panel**

⋮

**Managing ISDN Link**

If an ISDN Link is paired to the video system it can be managed from this page.

How to configure and use the ISDN Link are described in the ISDN Link documentation on <http://www.cisco.com/go/isdnlink-docs>

\* The peripherals shown in the illustration serve as examples. Your system may have different peripherals and video input/output configurations.

## User administration

You can manage your video conference system's user accounts from this page. You can create new users, edit the details of existing users, and delete users.

### The default user account

The system comes with a default administrator user account with full access rights. The user name is *admin* and no password is set.



It is highly recommended to set a password for the *admin* user.

Read more about passwords in the [Setting passwords](#) chapter.

### About user roles

A user account must hold one or a combination of several *user roles*.

The following three user roles, with *non-overlapping rights*, exist:

- ADMIN: A user holding this role can create new users and change most settings. The user neither can upload audit certificates nor change the security audit settings.
- USER: A user holding this role can make calls and search the phone book. The user can modify a few settings, e.g. adjusting the audio volume and changing the menu language.
- AUDIT: A user holding this role can change the security audit configurations and upload audit certificates.



An administrator user account with full access rights, like the default *admin* user, must possess all the three roles.

Navigate to: Configuration > User Administration

### User Administration

User	Roles	Status
admin	Admin, Audit, User	Active
user1	User	Active

[Add new user...](#)

**Default user account**

The system comes with *admin* as the default user account. This user has full access rights.

## User administration, continued

### Creating a new user account

Follow these steps in order to create a new user account:

1. Click [Add new user...](#)
2. Fill in the Username, Password and PIN code\*, and check the appropriate user roles check boxes.

As a default the user has to change the password and PIN code when signing in for the first time.

Do not fill in the Client Certificate DN (Distinguished Name) field unless you want to use certificate login on https.

3. Set the Status to **Active** to activate the user.
4. Click [Create User](#) to save the changes.

Use the [Back](#) button to leave without making any changes.

Navigate to: Configuration > User Administration

### User Administration

User	Roles
admin	Admin, Audit, User
user1	User

[Add new user...](#)

### Add new user [← Back](#)

Username

Roles  Admin  
 Audit  
 User

Status  Active  
 Inactive

Client Certificate DN

Require password change on next user sign in  
 Require PIN change on next user sign in

Password

Repeat Password

PIN

Repeat PIN

Used if login-required has been enabled on telepresence device menu

[Create User](#)

\* The password is used with the web interface and command line interface; the PIN code is used with the remote control and on-screen menu when the *Video OSD LoginRequired* setting is switched **On**.

## User administration, continued

### Changing user privileges

Follow these steps in order to change the user privileges:

1. Click the name of an existing user to open the Editing user window.
2. Check the appropriate user roles check boxes, decide if the user has to change the password and PIN code on the next sign in, and fill in the Client Certificate DN field if using certificate login on https.
3. Click [Update User](#) to save the changes.  
Use the [Back](#) button to leave without making any changes.

### Changing the password or PIN code

Follow these steps in order to change the password or PIN code\*:

1. Click the name of an existing user to open the Editing user window.
2. Enter the new password or PIN code in the appropriate input fields.
3. Click [Change Password](#) or [Change PIN](#) to save the change.  
Use the [Back](#) button to leave without making any changes.

\* The password is used with the web interface and command line interface; the PIN code is used with the remote control and on-screen menu when the *Video OSD LoginRequired* setting is switched **On**.

Navigate to: Configuration > User Administration

### User Administration

User	Roles
admin	Admin
user1	User

[Add new user...](#)

### Editing user: user1

[← Back](#)

#### User Privileges

Roles

Admin

Audit

User

Status

Active

Inactive

Client Certificate DN

Require password change on next user sign in

Require PIN change on next user sign in

[Update User](#)

#### Change Password

Password

Repeat Password

[Change Password](#)

#### Change PIN

PIN

Repeat PIN

Used if login-required has been enabled on telepresence device menu

[Change PIN](#)

## User administration, continued

### Deactivating a user account

Follow these steps in order to deactivate a user account:



Always keep at least one user with ADMIN rights **Active**.

1. Click the name of an existing user to open the Editing user window.
2. Set the Status to **Inactive**.
3. Click [Update User](#) to save the changes.  
Use the [Back](#) button to leave without making any changes.

### Deleting a user account

Follow these steps in order to delete a user account:



It is not possible to delete the default *admin* user. There must always be at least one user with ADMIN rights on the system.

1. Click the name of an existing user to open the Editing user window.
2. Click [Delete <user name>...](#) and confirm when prompted.

Navigate to: Configuration > User Administration

### User Administration

User	Roles
admin	Admin Audit User
user1	User

[Add new user...](#)

### Editing user: user1

[← Back](#)

---

**User Privileges**

Roles

- Admin
- Audit
- User

Status

- Active
- Inactive

Client Certificate DN

---

**Delete user**

[Delete user1...](#)

## Adding a sign in banner

A sign in banner is a message that is shown to the user when signing in.

If a system administrator wants to provide initial information to all users, he can create a sign in banner. The message will be shown when the user signs in to the web interface or the command line interface.

Navigate to: Configuration > Sign In Banner

### Sign In Banner

The Sign In Banner will be displayed when signing in using SSH, telnet, web and RS-232.

The information you type here will be shown to all users when they sign in.

Save

**Adding a sign in banner**

Enter the message that you want to present to the user when signing in, and click [Save](#) to activate the banner.

```
login as: admin
The information you type here will be shown to all users when they sign in.
using keyboard-interactive authentication.
Password: █
```

CISCO Codec: MySystem

http://192.168.1.128

The information you type here will be shown to all users when they sign in.

**Sign In**

Username:

Password:

System name: MySystem



## Managing startup scripts

You can create one or more startup scripts\* that will run every time the video system starts up.

A startup script contains commands (xCommand) and configurations (xConfiguration) that will be executed as part of the start up procedure. A few commands and configurations cannot be placed in a startup script, e.g. xCommand Boot. It is not possible to save a script containing illegal commands and configurations.

Syntax and semantics for xCommand and xConfiguration are explained in the API guide for the product.

If you have more than one startup script, they will run in the order from top to bottom of the list.

Navigate to: Configuration > Startup Scripts

### Startup Scripts

Scripts

my\_script ●

[Create new...](#)

### Edit script

my\_script

```
xConfiguration SystemUnit MenuLanguage: Norwegian
xConfiguration UserInterface TouchPanel DefaultPanel: DialPad
xConfiguration Conference AutoAnswer Mode: On
xConfiguration Conference AutoAnswer Delay: 10
```

[Save](#)
[Cancel](#)
[Run](#)
[On](#)
[Off](#)
[Delete](#)

### Creating a startup script

1. Click [Create new...](#)
2. Enter a name for your script in the title input field.
3. Enter the commands (xConfiguration or xCommand) you want to issue in the command input field. Start each command on a new line.
4. Click [Save](#).

### Running the script immediately

Select the script you want to run and click [Run](#).

### Running the script at every start up

Select the script you want to activate and click [On](#).

### Not running the script at start up

Select the script you want to deactivate and click [Off](#).

### List of startup scripts

Startup scripts are listed here. A green dot appears next to an active script; a red ring appears next to an inactive script.

### Deleting a script

Select the script you want to delete and click [Delete](#).

\* The script name and commands shown in the illustration serve as examples. You may make your own scripts.

## Application programming interface

The application programming interface (API) is a tool for integration professionals and developers working with this video system. The API is described in detail in the API guide for the system.

### XML files

The XML files are part of the codec's API. They structure information about the codec in a hierarchy.

- *Configuration.xml* contains the current system settings (configuration). These settings are controlled from the web interface or from the API (Application Programmer Interface).
- The information in *status.xml* is constantly updated by the system to reflect system and process changes. The status information is normally monitored from the API.
- *Command.xml* contains an overview of the commands available to instruct the system to perform an action. The commands are issued from the API.
- *Valuespace.xml* contains an overview of all the value spaces used in the system settings, status information, and commands.

### API commands

Commands (xCommand) and configurations (xConfiguration) can be executed from this web page. Syntax and semantics are explained in the API guide for the product.

Navigate to: Configuration > API

### API

#### XML API

The XML files below are a part of the codec's API, and can be used by external services to inspect the state and configuration of the codec. The files are protected using Basic Authentication, thus you may be prompted for a user name and password.

File Name	Description
<a href="#">/configuration.xml</a>	Configuration settings
<a href="#">/status.xml</a>	Endpoint status parameters
<a href="#">/command.xml</a>	Available API commands
<a href="#">/valuespace.xml</a>	Value spaces of the XML files

#### Execute API commands and configurations

In the field below you can enter API commands (xCommand and xConfiguration) directly.

For example: xCommand Dial Number: "person@example.com" Protocol: Sip

Enter commands...

#### Opening an XML file

Click the file name to open the XML file.

#### Executing API commands

Enter a command, or a sequence of commands, in the text area and click *Execute* to issue the command(s).

## Managing the video system's certificates

Certificate validation may be required when using TLS (Transport Layer Security).

A server or client may require that your video system presents a valid certificate to them before communication can be set up.

The video system's certificates are text files that verify the authenticity of the system. These certificates may be issued by a certificate authority (CA).

The certificates are listed as shown in the illustration to the right\*. They can be used for the following services: HTTPS, SIP and IEEE 802.1X.

You can store several certificates on the system, but only one certificate can be used for each service at a time.

If authentication fails, the connection will not be established.



Contact your system administrator to obtain the following file(s):

- Certificate (file format: .PEM)
- Private key, may be included in the same file as the certificate (file format: .PEM format)
- Password (required only if the private key is encrypted)

The certificate and the private key will be stored in the same file on the video system.

Navigate to: Configuration > Security: Certificates tab

### Security

Certificates
CAs
Strong Security Mode
Non-persistent Mode
CUCM

Certificate	Issuer	HTTPS	SIP	802.1X	
Certificate_A	CertificateAuthority_A	<input type="checkbox"/>	<input checked="" type="checkbox"/>	<input type="checkbox"/>	Delete... <span style="float: right;">View Certificate</span>
Certificate_B	CertificateAuthority_B	<input checked="" type="checkbox"/>	<input type="checkbox"/>	<input type="checkbox"/>	Delete... <span style="float: right;">View Certificate</span>

#### Add Certificate

Certificate

Private key (optional)

Password (optional)

This system supports PEM formatted certificate files (.pem). The certificate file may contain the certificate and a RSA or DSA encrypted private key with or without a password. Optionally the private key file may be supplied separately.

#### Adding a certificate

1. Click [Browse...](#) and find the Certificate and Private key file(s) on your computer.
2. Fill in the [Password](#) if required.
3. Click [Add certificate...](#) to store the certificate on your system.

#### Enabling and disabling certificates

Use the buttons to switch a certificate on or off for the different services.

You can also view a certificate, and delete a certificate using the corresponding buttons.

\* The certificates and certificate issuers shown in the illustration serve as examples. Your system may have other certificate(s).

## Managing the list of trusted certificate authorities

Certificate validation may be required when using TLS (Transport Layer Security).

Your video system may be set up to require that a server or client presents its certificate to the system before communication can be set up.

The certificates are text files that verify the authenticity of the server or client. The certificates must be signed by a trusted certificate authority (CA).

To be able to verify the signature of the certificates, a list of trusted CAs must reside on the video system. The certificates of the CAs are listed as shown in the illustration to the right\*.

The list must include all CAs needed in order to verify certificates for HTTPS, SIP and IEEE 802.1X connections.

If the server cannot be authenticated, the connection will not be established.

Navigate to: Configuration > Security: CAs tab

Certificates
CAs
Strong Security Mode
Non-persistent Mode
CUCM

Certificate	Issuer	Delete...	View Certificate
CA_Certificate_1	Issuer_1		

**Add Certificate Authority**

CA file  Browse...

This system supports PEM formatted files (.pem) with one or more CA certificates within the file.

Add certificate authority...

### Uploading a list of certificate authorities

The entries in a new file with CA certificates will be appended to the existing list, that is, the previously stored certificates will not be deleted.

- i. Click [Browse...](#) and find the file containing a list of CA certificates (file format: .PEM) on your computer.
- ii. Click the [Add certificate authority...](#) to store the new CA certificate(s) on your system.

Contact your system administrator to obtain the CA certificate list (file format: .PEM).

### Viewing and deleting certificates

You can view a certificate, and delete a certificate using the corresponding buttons.

\* The certificate and certificate issuers shown in the illustration serve as examples. Your system will have other certificate(s).

## Adding audit certificates

Audit logging records all sign in activity and configuration changes on your video system.

Audit logging is disabled by default, but you can enable it using the [Security > Audit > Logging > Mode](#) setting on the on-screen menu or the web interface.

In ExternalSecure audit logging mode the video system sends encrypted audit logs to an external audit server (syslog server), which identity must be verified by a signed certificate.

To be able to verify the signature of the audit server certificates, a list of trusted audit certificate authorities (CAs) must reside on the video system.

If the audit server cannot be authenticated, the logs will not be sent.



Always upload the audit certificate list before enabling secure audit logging.

Navigate to: Configuration > Security: CAs tab / Configuration > System Configuration

### Security

[Certificates](#) | **CAs** | [Strong Security Mode](#) | [Non-persistent Mode](#) | [CUCM](#)

---

#### Add Audit Server Certificate Authority

Audit CA list:  [Browse...](#)

This CA list is used for reporting to the audit server.  
 This system supports PEM formatted files (.pem) with one or n

Add audit certificate

**1. Upload a list of audit server certificates**

The entries in a new file with CA certificates will overwrite the existing list, that is, any previously stored audit certificates will be lost when you add a new file.

- i. Click [Browse...](#) and find the file containing the list of audit CA certificates (.PEM format) on your computer.
- ii. Click [Add audit certificate](#) to store the certificate(s) on your system.

Contact your system administrator to obtain the Audit CA list (file format: .PEM).

### System Configuration

Set

| **Security** | [Refresh](#)

Audio

Cameras

Conference

Experimental

FacilityService

GPIO

H323

Logging

Network

NetworkPort

Security

SerialPort

#### Audit

iii
 Logging Mode:  [Save](#)  
 OnError Action:  [Save](#)  
 Server:  [Save](#)

---

ii
 Address:  [Save](#)  
 Port:  [Save](#)  
 PortAssignment:  [Save](#)

---

Session:  [Save](#)

i
RTP Ports Range

**2. Enable secure audit logging**

- i. Go to the [System Configuration](#) page and choose the [Security](#) category.
- ii. Enter the [Address](#) of the audit server. If you choose **Manual PortAssignment**, you must also enter a [Port](#) number for the audit server. Click [Save](#) for the changes to take effect.
- iii. Choose **ExternalSecure** from the [Logging Mode](#) drop-down list. Click [Save](#) for the change to take effect.

## Setting strong security mode

Strong security mode should be used only when compliance with DoD JITC regulations is required.



Read the provided information carefully before setting strong security mode.

Strong security mode sets very strict password requirements, and requires all users to change their password on the next sign in.

Software upload from TMS, web snapshots and calling from the web interface are prohibited in strong security mode.

Navigate to: Configuration > Security: Strong Security Mode tab

**Security**

Certificates   CAs   **Strong Security Mode**   Non-persistent Mode   CUCM

Strong Security Mode is **not** enabled.

Strong Security Mode is required to adhere to U.S. Department of Defense JITC regulations.

It will introduce the following:

- All users and administrators must change their password and PIN on the next sign in
- New passwords must meet the following criteria:
  - Minimum 15 characters
  - Minimum 2 uppercase alphabetic characters
  - Minimum 2 lowercase alphabetic characters
  - Minimum 2 numerical characters
  - Minimum 2 non-alphanumeric (special) characters
  - No more than 2 consecutive characters may be the same
  - Must be different from the last 10 previous passwords used
  - Not more than 2 characters from the previous password can be in the same position
- Passwords must be changed at least every 30 days
- Passwords cannot be changed more than once per 24 hours
- 3 failed signins will lock the user account until an administrator re-activates the account
- Software upload from TMS will not be possible
- Web snapshots will not be available

**Enable Strong Security Mode...**

### Setting strong security mode

Read carefully about the consequences of strong security mode before you continue.

1. If you want to use strong security mode, click [Enable strong security mode](#). Confirm your choice in the dialog box that appears.

The system will restart automatically.

2. Change the password when you are prompted. The new password must meet the strict criteria as described.

How to change the system password is described in the [Setting passwords](#) section.

**Security**

Certificates   CAs   **Strong Security Mode**

Strong Security Mode is enabled.

**Disable Strong Security Mode...**

### Return to normal mode

1. When in strong security mode, the system can be restored to normal mode by clicking [Disable strong security mode...](#)
2. The system will restart automatically.

## Changing the persistency mode

By default, all persistency settings are set to **Persistent**. This means that configurations, call history, internal logs, local phonebook / favorites list and IP connectivity information are stored as normal. A system restart does not delete information.

As a general rule, we recommend **NOT** to change the default settings for persistency. But in the case were a new user is not supposed to see or trace back to any kind of logged information from the previous session, **Non-persistent** mode must be used.



In order to clear/delete information that was stored before changing to Non-persistent mode, you should consider to factory reset the video system.

There is more information about performing a factory reset in the [Factory resetting](#) appendix.

When in Non-persistent mode, the following information will be lost/cleared each time the system restarts:

- System Configuration changes that have been made since the last system restart.
- Information about calls that are placed or received since the last system restart (call history).
- Internal log files that has been made since the last system restart.
- Changes that are made to the local phonebook / favorites list since the last system restart.
- All IP related information (DHCP) from the last session.

### Checking the persistency status

The radio buttons that are active when you open the [Security](#) page and go to the [Non-persistent Mode](#) tab, shows the current persistency status of the video system.

You can also see the status by checking [Security > Persistency](#) on the [Configuration > System Status](#) page.

Navigate to: Configuration > Security: Non-persistent Mode tab

Certificates CAs Strong Security Mode Non-persistent Mode CUCM

For use in secure environments, system components can be set in non-persistent mode. This will cause the selected system component to be reset to a saved state when the device is shut down. Changing non-persistency settings will automatically reboot the TelePresence device.

Configurations  Persistent  Non-persistent

Call History  Persistent  Non-persistent

Internal Logging  Persistent  Non-persistent

Local Phonebook  Persistent  Non-persistent

DHCP  Persistent  Non-persistent

[Save and reboot...](#)

**Changing the persistency settings**

1. Set the persistency settings for the five categories as desired.
2. Click [Save and reboot...](#)

The system will restart. After the restart, behavior according to the new persistency settings will start.

Note that logs, configurations etc. that was stored before you switch to Non-persistent mode, will not be cleared or deleted.

## Deleting trust lists (CUCM only)

The information on this page is only relevant for video systems that are registered to a Cisco Unified Communications Manager (CUCM).

The web interface can be used to delete existing trust lists (CTL and ITL) that are stored on the video system. Normally, you will not delete the old CTL and ITL files, but there are a few cases when you will need to delete them.

For more information about CUCM and trust lists, read the *Administering TC Endpoints on CUCM* guide available on the Cisco web site.

Navigate to: Configuration > Security: CUCM tab

### Security

Certificates
CAs
Strong Security Mode
Non-persistent Mode
CUCM

<p>CUCM status</p> <p>CTL status</p> <p>ITL status</p> <p>LSC status</p> <p>Operation status</p>	<p><b>CUCM is enabled.</b></p> <p><b>CTL is installed.</b></p> <p><b>ITL is installed.</b></p> <p><b>Certificates are not installed.</b></p> <p><b>No pending operations.</b></p>
--	---



## Troubleshooting

The troubleshooting page lists the status for some common sources of errors. The list may be different for different products and installations\*.

Note that critical issues and errors are clearly marked in red color; warnings are yellow.

Navigate to: Diagnostics > Troubleshooting

**Run diagnostics**

Click [Re-run diagnostics](#) to make sure the information in the list is up-to-date.

**Leave standby mode**

This button is only visible when the system is in standby mode. If in standby mode, click [Deactivate standby](#) to wake up the system.

### Troubleshooting

Deactivate standby
Re-run diagnostics

Diagnostics that helps to identify issues that may cause the TelePresence system to underperform or fail to work as expected.

**CRITICAL:** Valid Admin Password  
No admin password set. Please [secure the system with an admin password](#).

**WARNING:** Do not disturb mode  
Do not disturb is turned on. Until this is **turned off**, the system cannot accept calls.

**OK:** System Name  
The device has a [system name](#) set.

**OK:** System Temperature  
The system is running at an acceptable temperature.

**OK:** Standby Control

**Not Applicable:** H320 Gateway Status

**Not Applicable:** ISDN Link compatibility

\* The messages shown in the illustration serve as examples. Your system may show other information.

## Downloading log files

The log files\* are Cisco specific debug files which may be requested by the Cisco support organization if you need technical support.

The *current log files* are time stamped event log files.

All current log files are archived in a time stamped *historical log file* each time the system restarts. If the maximum number of historical log files is reached, the oldest one will be overwritten.

### About extended logging mode

Extended logging mode may be switched on to help diagnose network issues and problems during call setup. While in this mode more information is stored in the log files.

Note that extended logging use more of your video system's resources, and may cause your video system to under-perform. You should only use extended logging mode when troubleshooting an issue.

Navigate to: Diagnostics > Log Files

### Downloading all log files

Click [Download logs archive](#) and follow the instructions.

You can choose whether to include the call history in the archive or not; and you can choose whether to include the full call history or to make the caller/callee anonymous. Use the drop down list to include the preferred call history list.

### Start extended logging

1. Use the drop down list to choose the duration of extended logging.
2. Click [Start extended logging](#).

You can stop the extended logging before it times out by clicking the [Stop extended logging](#) button that appears when extended logging is on.

### Log Files

#### Download log archive

A full archive of the logs on the device is useful for diagnosing problems.

This archive includes all current and historical logs. Call history is not included by default.

Download logs archive... ▾

#### Extended logging

To help diagnose network issues and problems during call setup, the system can enter a timed extended logging mode. This mode is resource intensive, and populates the existing logs with more detailed information.

Start extended logging for 5 minutes ▾

Extended logging is off.

#### Current logs

File Name ▾	Size	Last Modified
arm0-system.log	11 KB	2013-10-21 09:13
arm1-system.log	11 KB	2013-10-21 09:13
arm2-system.log	11 KB	2013-10-21 09:13

#### Historical logs

File Name ▾	Size	Last Modified
log.0.tar.gz	22 KB	2009-07-07 15:37
log.1.tar.gz	31 KB	2010-01-22 09:34

**Open/save one log file**

Click the file name to open the log file in the web browser; right click to save the file on the computer.

\* The log files shown in the illustration serve as examples. Your system may have other files.

## Upgrading the system software

This video conference system is using TC software. The version described in this document is TC6.3.



Contact your system administrator if you have questions about the software version.

### Software release notes

For a complete overview of the news and changes, we recommend reading the Software Release Notes (TC6).

Go to: [http://www.cisco.com/en/US/products/ps11422/tsd\\_products\\_support\\_series\\_home.html](http://www.cisco.com/en/US/products/ps11422/tsd_products_support_series_home.html)

### New software

For software download, go to the Cisco Download Software web page:

<http://www.cisco.com/cisco/software/navigator.html>.

Then navigate to your product.

The file name is something like “s52000tc6\_3\_0.pkg” (each software version has a unique file name).

### Release key and option keys

You need a valid *release key* to be able to use the TC software. As from version TC6.1, any TC release key will do.

For older releases the release key is specific for each main release (e.g. TC4, TC5, TC6). If you want to downgrade the software to TC6.0 or older, take care to have the correct key.

An *option key* is required to activate optional functionality. You may have several option keys in your system.

The available options are:

- Premium resolution
- MultiSite
- Dual display (only Codec C40)

Navigate to: Maintenance > Software Upgrade

### Software Upgrade

Software package

Current software version is TC6.3.0

Upgrade automatically after upload

Release key   The system has valid release keys for TC5, TC6 and TC6.1+

Option key

---

#### About Release and Options Keys

Any valid release key may be used to upgrade to a newer version.

Successful downgrade to TC6.0 or lower will require a valid release key for the specific version you are going to downgrade to.

Contact your Cisco representative to obtain the required release key and information about available option keys. You need to provide the serial number to get release and option keys. The serial number for this TelePresence device is ...

#### Adding release and option keys

If you already have a valid release key and the proper option keys installed on your system, you can skip this point and continue with the software installation.

If you do not have the required key(s), contact your Cisco representative to obtain them. Then perform the following steps:

- Enter the *Release key* in the appropriate text input field and click [Add](#).
- Enter an *Option Key* in the appropriate text input field and click [Add](#).

If you have more than one option key, repeat step ii for all of them.

Each system has unique keys, for example:
 

- 1TC006-1-0C22E348 (release key)
- 1R000-1-AA7A4A09 (option key)

#### Installing new software

Download the appropriate software package from the Cisco Software Download web page (see link to the left) and store it on your local computer. This is a .pkg file.

- Click [Browse...](#) and find the downloaded .pkg file that contains the new software.
- Check the [Upgrade automatically after upload](#) check box, then click [Upload](#) to start the installation process straight away.

Keep the check box unchecked if you want to upload the software now and do the installation later.

The complete installation may take up to 30 minutes. You can follow the progress on the web page. The system restarts automatically after the installation.

You must sign in anew in order to continue working with the web interface after the restart.

## Backup and restore

All the system settings, which are available on the System configuration page, can be listed on-screen or stored as a text file (.tsh).

The .tsh file can be loaded back onto the system, thereby restoring the configuration.

Navigate to: Maintenance > Backup and Restore

### Backing up or showing the current configuration

Click [Preview backup](#) to display the current settings on-screen.

Click [Take backup](#) to store the configuration as a text file.

### Backup and Restore

#### Take backup of configuration

This will create a backup file of the configurations on the TelePresence system. The backup file can be used to restore the TelePresence system to a previous state.

[Take backup](#) [Preview backup](#)

#### Restore configuration from backup

Restore the TelePresence system from a backup file. Some configurations may require a reboot to take effect.

[Browse...](#) [Restore](#)

### Restoring an earlier configuration

Click [Browse...](#) and find the file with the configuration you want to restore.

Click [Restore](#) to reconfigure the system as defined in the file.

## System recovery: Revert to the previously used software version

If there is a severe problem with the video system, switching to the previously used software version may help solving the problem. The previously used software image still resides on the system, so you do not have to download the software again.

Reverting to the previously used software version should only be done by a system administrator or in contact with Cisco technical support.

We strongly recommend that you backup your system's log files and configuration before you swap to the other software image.

Navigate to: Maintenance > System Recovery : Backup tab and Software Recovery Swap tab

### System Recovery

In order to recover the system when experiencing a severe issue, a Software Recovery Swap or a Factory Reset can be performed. These recovery methods should only be attempted by a system administrator or in contact with Cisco technical support. The preferred recovery method is to perform a Software Recovery Swap and Factory Reset as last resort.

Backup   Software Recovery Swap   Factory Reset

A factory reset deletes all logs and system configurations. Please consider taking a backup of logs and the system's configuration before performing a factory reset.

The log files may be useful to help Cisco identify the cause of the issue you are experiencing. The configuration backup may be used to restore the configurations back to the current settings.

Download Logs   Download Configuration Backup

Backup   Software Recovery Swap   Factory Reset

A Software Recovery Swap will change the running software to the previously used software image which is stored on an inactive partition.

You are currently running TC6.3.0.

Switch to software: TC6.1.0

#### 1. Backing up log files and system configuration

We recommend that you backup your system's log files and configuration before you swap to the other software image.

Click [Download Logs](#) and [Download Configuration Backup](#) and follow the instructions to save the files on your computer.

#### 2. Reverting to the previously used software version

1. Revert to the previously used software version by clicking [Switch to software TCx.y.z...](#), where x.y.z indicates the software version.
2. Click [Yes](#) to confirm your choice, or [Cancel](#) if you have changed your mind.

Wait while the system resets. The system will restart automatically when finished.

## System recovery: Factory reset

If there is a severe problem with the video system, the last resort may be to reset it to its default factory settings. Always consider reverting to the previously used software image before performing a factory reset. In many situations this will recover the system\*.

A factory reset should only be performed by a system administrator or in contact with Cisco technical support.

When factory resetting the video system the following happens:

- The call logs will be deleted.
- Passwords will be reset to default.
- All system parameters will be reset to default values.
- All files that have been uploaded to the system will be deleted. This includes, but is not limited to, custom backgrounds, certificates, and the favorites list (My contacts).
- The previous (inactive) software image will be deleted.
- Release keys and option keys will **not** be affected.

The system restarts automatically after the reset. It is using the same software image as before.

We strongly recommend that you backup your system's log files and configuration before you perform a factory reset.



It is *not* possible to undo a factory reset.

There is more information about performing a factory reset in the ► [Factory resetting](#) appendix.

\* Read about software swapping in the ► [System recovery: Revert to the previously used software version](#) section.

Navigate to: Maintenance > System Recovery : Backup tab and Factory Reset tab

### System Recovery

In order to recover the system when experiencing a severe issue, a Software Recovery Swap or a Factory Reset can be performed. These recovery methods should only be attempted by a system administrator or in contact with Cisco technical support. The preferred recovery method is to perform a Software Recovery Swap and Factory Reset as last resort.

Backup
Software Recovery Swap
Factory Reset

A factory reset deletes all logs and system configurations. Please consider taking a backup of logs and the system's configuration before performing a factory reset.

The log files may be useful to help Cisco identify the cause of the issue you are experiencing. The configuration backup may be used to restore the configurations back to the current settings.

Download Logs
Download Configuration Backup

Backup
Software Recovery Swap
Factory Reset

This will reset the TelePresence device to factory default settings, followed by an automatic reboot of the TelePresence device.

- The call logs will be deleted.
- All system parameters will be reset to default values.
- All files that have been uploaded to the TelePresence device will be deleted. This includes, but are not limited to, custom backgrounds, ring tones, certificates, and the local phonebook.
- Release keys and option keys will **not** be affected.
- Any alternate software image will be deleted.

**Warning:** A factory reset cannot be undone.

Perform a factory reset...

#### 1. Backing up log files and system configuration

We strongly recommend that you backup your system's log files and configuration before you perform a factory reset; otherwise these data will be lost.

Click [Download Logs](#) and [Download Configuration Backup](#) and follow the instructions to save the files on your computer.

#### 2. Performing a factory reset

Read the provided information carefully before you restore the factory settings by clicking [Perform a factory reset...](#)

Click [Yes](#) to confirm your choice, or [Cancel](#) if you have changed your mind.

Wait while the system resets. The system will restart automatically when finished.

## Restarting the system

The system can be shut down or restarted remotely using the web interface.

Navigate to: Maintenance > Restart

### Restart

- Restarting the TelePresence device will make it unavailable for several minutes.
- Shutting down the TelePresence device will require physical presence to turn it on again.

Restart TelePresence device...
Shutdown TelePresence device...

### Restarting the system

Click [Restart TelePresence device...](#) to restart the system.

 It will take a few minutes before the system is ready for use.

### Shutting down the system

Click [Shutdown TelePresence device...](#) to shut down the system.

 The system cannot be turned on again remotely; you must press its power button physically to turn it on.

# Chapter 3

## System settings



## Overview of the system settings

In the following pages you will find a complete list of the system settings which are configured from the [System Configuration](#) page on the web interface. The examples show either the default value or an example of a value.

Open a web browser and enter the IP address of the video system; then sign in.



Navigate to [Home > Settings > System Information](#) using the remote control and on-screen menu, or tap [Settings \(⚙️\) > System Information](#) on the Touch controller to find the system's IP address (IPv4 or IPv6).

<b>Audio settings</b> .....	<b>60</b>	Audio SoundsAndAlerts KeyTones Mode.....	65
Audio Input HDMI [2] Level.....	60	Audio SoundsAndAlerts RingTone.....	65
Audio Input HDMI [2] Mode.....	60	Audio SoundsAndAlerts RingVolume.....	65
Audio Input HDMI [2] VideoAssociation		Audio Volume.....	65
MuteOnInactiveVideo.....	60	<b>Cameras settings</b> .....	<b>66</b>
Audio Input HDMI [2] VideoAssociation VideoInputSource.....	60	Cameras Camera [1..7] Backlight.....	66
Audio Input Line [1..2] Channel.....	61	Cameras Camera [1..7] Brightness Level.....	66
Audio Input Line [1..2] Equalizer ID.....	60	Cameras Camera [1..7] Brightness Mode.....	66
Audio Input Line [1..2] Equalizer Mode.....	60	Cameras Camera [1..7] DHCP.....	68
Audio Input Line [1..2] Level.....	61	Cameras Camera [1..7] Flip.....	66
Audio Input Line [1..2] LoopSuppression.....	61	Cameras Camera [1..7] Focus Mode.....	66
Audio Input Line [1..2] Mode.....	61	Cameras Camera [1..7] Gamma Level.....	67
Audio Input Line [1..2] VideoAssociation		Cameras Camera [1..7] Gamma Mode.....	67
MuteOnInactiveVideo.....	61	Cameras Camera [1..7] IrSensor.....	67
Audio Input Line [1..2] VideoAssociation VideoInputSource.....	61	Cameras Camera [1..7] Mirror.....	67
Audio Input Microphone [1..2]/[1..4] EchoControl		Cameras Camera [1..7] MotorMoveDetection.....	67
Dereverberation.....	62	Cameras Camera [1..7] Whitebalance Level.....	68
Audio Input Microphone [1..2]/[1..4] EchoControl Mode.....	62	Cameras Camera [1..7] Whitebalance Mode.....	68
Audio Input Microphone [1..2]/[1..4] EchoControl		<b>Conference settings</b> .....	<b>69</b>
NoiseReduction.....	62	Conference [1..1] AutoAnswer Delay.....	69
Audio Input Microphone [1..2]/[1..4] Equalizer ID.....	62	Conference [1..1] AutoAnswer Mode.....	69
Audio Input Microphone [1..2]/[1..4] Equalizer Mode.....	62	Conference [1..1] AutoAnswer Mute.....	69
Audio Input Microphone [1..2]/[1..4] Level.....	63	Conference [1..1] CallProtocolIPStack.....	69
Audio Input Microphone [1..2]/[1..4] Mode.....	63	Conference [1..1] DefaultCall Protocol.....	70
Audio Input Microphone [1..2]/[1..4] Type.....	63	Conference [1..1] DefaultCall Rate.....	70
Audio Input Microphone [1..2]/[1..4] VideoAssociation		Conference [1..1] DoNotDisturb DefaultTimeout.....	70
MuteOnInactiveVideo.....	63	Conference [1..1] DoNotDisturb Mode.....	69
Audio Input Microphone [1..2]/[1..4] VideoAssociation		Conference [1..1] Encryption Mode.....	70
VideoInputSource.....	63	Conference [1..1] FarEndControl Mode.....	70
Audio Microphones Mute Enabled.....	65	Conference [1..1] FarEndControl SignalCapability.....	70
Audio Output HDMI [1] Level.....	63	Conference [1..1] IncomingMultisiteCall Mode.....	73
Audio Output HDMI [1] Mode.....	64	Conference [1..1] MaxReceiveCallRate.....	71
Audio Output Line [1..2] Channel.....	64	Conference [1..1] MaxTotalReceiveCallRate.....	71
Audio Output Line [1..2] Equalizer ID.....	64	Conference [1..1] MaxTotalTransmitCallRate.....	71
Audio Output Line [1..2] Equalizer Mode.....	64	Conference [1..1] MaxTransmitCallRate.....	71
Audio Output Line [1..2] Level.....	64	Conference [1..1] MicUnmuteOnDisconnect Mode.....	69
Audio Output Line [1..2] Mode.....	64	Conference [1..1] Multipoint Mode.....	73
Audio Output Line [1] Type.....	64		
Audio Output Line [2] Type.....	65		

Conference [1..1] Presentation OnPlacedOnHold .....	72	Network [1..1] IEEE8021X Mode .....	83	NetworkServices NTP Address .....	90
Conference [1..1] Presentation Policy.....	72	Network [1..1] IEEE8021X Password.....	84	NetworkServices NTP Mode .....	90
Conference [1..1] Presentation RelayQuality .....	72	Network [1..1] IEEE8021X TlsVerify.....	84	NetworkServices SIP Mode.....	88
Conference [1..1] VideoBandwidth MainChannel Weight.....	71	Network [1..1] IEEE8021X UseClientCertificate .....	84	NetworkServices SNMP CommunityName .....	91
Conference [1..1] VideoBandwidth Mode.....	71	Network [1..1] IPStack.....	80	NetworkServices SNMP Host [1..3] Address .....	91
Conference [1..1] VideoBandwidth PresentationChannel Weight.....	72	Network [1..1] IPv4 Address .....	80	NetworkServices SNMP Mode .....	91
<b>FacilityService settings.....</b>	<b>74</b>	Network [1..1] IPv4 Gateway.....	80	NetworkServices SNMP SystemContact .....	91
FacilityService Service [1..5] CallType .....	74	Network [1..1] IPv4 SubnetMask.....	80	NetworkServices SSH AllowPublicKey .....	91
FacilityService Service [1..5] Name .....	74	Network [1..1] IPv6 Address .....	81	NetworkServices SSH Mode .....	91
FacilityService Service [1..5] Number .....	74	Network [1..1] IPv6 Assignment.....	80	NetworkServices Telnet Mode .....	88
FacilityService Service [1..5] Type .....	74	Network [1..1] IPv6 DHCPOptions .....	81	NetworkServices WelcomeText.....	88
<b>GPIO settings.....</b>	<b>75</b>	Network [1..1] IPv6 Gateway.....	81	NetworkServices XMLAPI Mode .....	88
GPIO Pin [1..4] Mode .....	75	Network [1..1] MTU.....	85	<b>Phonebook settings .....</b>	<b>93</b>
<b>H323 settings.....</b>	<b>76</b>	Network [1..1] QoS Diffserv Audio.....	82	Phonebook Server [1..1] ID.....	93
H323 NAT Address .....	76	Network [1..1] QoS Diffserv Data.....	82	Phonebook Server [1..1] Type .....	93
H323 NAT Mode .....	76	Network [1..1] QoS Diffserv ICMPv6 .....	83	Phonebook Server [1..1] URL .....	93
H323 Profile [1..1] Authentication LoginName.....	76	Network [1..1] QoS Diffserv NTP .....	83	<b>Provisioning settings.....</b>	<b>94</b>
H323 Profile [1..1] Authentication Mode.....	76	Network [1..1] QoS Diffserv Signalling.....	83	Provisioning Connectivity .....	94
H323 Profile [1..1] Authentication Password .....	77	Network [1..1] QoS Diffserv Video.....	82	Provisioning ExternalManager Address.....	95
H323 Profile [1..1] CallSetup Mode.....	77	Network [1..1] QoS Mode .....	82	Provisioning ExternalManager AlternateAddress.....	95
H323 Profile [1..1] Gatekeeper Address .....	77	Network [1..1] QoS RemoteAccess Allow.....	86	Provisioning ExternalManager AlternateAddress.....	95
H323 Profile [1..1] Gatekeeper Discovery.....	77	Network [1..1] Speed .....	85	Provisioning ExternalManager Domain .....	95
H323 Profile [1..1] H323Alias E164 .....	77	Network [1..1] TrafficControl Mode.....	85	Provisioning ExternalManager Path .....	95
H323 Profile [1..1] H323Alias ID.....	77	Network [1..1] VLAN Voice Mode .....	86	Provisioning ExternalManager Protocol .....	95
H323 Profile [1..1] PortAllocation.....	78	Network [1..1] VLAN Voice VlanId.....	86	Provisioning HttpMethod .....	94
<b>Logging settings.....</b>	<b>79</b>	<b>NetworkPort settings.....</b>	<b>87</b>	Provisioning LoginName .....	94
Logging Mode.....	79	NetworkPort [2] Mode.....	87	Provisioning Mode .....	94
<b>Network settings.....</b>	<b>80</b>	<b>NetworkServices settings.....</b>	<b>88</b>	Provisioning Password.....	94
Network [1..1] DHCP RequestTFTPServerAddress .....	81	NetworkServices CTMS Encryption .....	92	<b>RTP settings.....</b>	<b>96</b>
Network [1..1] DNS Domain Name.....	81	NetworkServices CTMS Mode .....	92	RTP Ports Range Start.....	96
Network [1..1] DNS Server [1..3] Address.....	81	NetworkServices H323 Mode .....	88	RTP Ports Range Stop .....	96
Network [1..1] IEEE8021X AnonymousIdentity.....	84	NetworkServices HTTP Mode .....	88	<b>Security settings.....</b>	<b>97</b>
Network [1..1] IEEE8021X Eap Md5 .....	84	NetworkServices HTTPS Mode .....	89	Security Audit Logging Mode .....	97
Network [1..1] IEEE8021X Eap Peap .....	85	NetworkServices HTTPS OCSP Mode .....	90	Security Audit OnError Action.....	97
Network [1..1] IEEE8021X Eap Tls .....	85	NetworkServices HTTPS OCSP URL .....	90	Security Audit Server Address .....	97
Network [1..1] IEEE8021X Eap Ttls .....	85	NetworkServices HTTPS VerifyClientCertificate .....	89	Security Audit Server Port .....	97
Network [1..1] IEEE8021X Identity.....	84	NetworkServices HTTPS VerifyServerCertificate .....	89	Security Audit Server PortAssignment.....	97
		NetworkServices MultiWay Address .....	89	Security Session InactivityTimeout.....	98
		NetworkServices MultiWay Protocol .....	89	Security Session ShowLastLogon.....	98

<b>SerialPort settings</b> .....	<b>99</b>	<b>SystemUnit settings</b> .....	<b>105</b>	Video MainVideoSource .....	111
SerialPort BaudRate .....	99	SystemUnit CallLogging Mode .....	105	Video Monitors .....	117
SerialPort LoginRequired .....	99	SystemUnit ContactInfo Type .....	105	Video OSD AutoSelectPresentationSource .....	119
SerialPort Mode .....	99	SystemUnit IrSensor .....	106	Video OSD CallSettingsSelection .....	119
<b>SIP settings</b> .....	<b>100</b>	SystemUnit MenuLanguage .....	105	Video OSD EncryptionIndicator .....	118
SIP ANAT .....	100	SystemUnit Name .....	105	Video OSD InputMethod Cyrillic .....	120
SIP AuthenticateTransferror .....	100	<b>Time settings</b> .....	<b>107</b>	Video OSD InputMethod InputLanguage .....	120
SIP ListenPort .....	100	Time DateFormat .....	107	Video OSD LanguageSelection .....	118
SIP OCSPP DefaultResponder .....	100	Time TimeFormat .....	107	Video OSD LoginRequired .....	120
SIP OCSPP Mode .....	100	Time Zone .....	107	Video OSD MenuStartupMode .....	118
SIP PreferredIPMedia .....	100	<b>UserInterface settings</b> .....	<b>108</b>	Video OSD MissedCallsNotification .....	119
SIP PreferredIPSignaling .....	100	UserInterface TouchPanel DefaultPanel .....	108	Video OSD Mode .....	117
SIP Profile [1..1] Authentication [1..1] LoginName .....	102	<b>Video settings</b> .....	<b>109</b>	Video OSD MyContactsExpanded .....	119
SIP Profile [1..1] Authentication [1..1] Password .....	102	Video AllowWebSnapshots .....	120	Video OSD Output .....	119
SIP Profile [1..1] DefaultTransport .....	102	Video CamCtrlPip CallSetup Duration .....	115	Video OSD TodaysBookings .....	119
SIP Profile [1..1] DisplayName .....	102	Video CamCtrlPip CallSetup Mode .....	115	Video OSD VirtualKeyboard .....	118
SIP Profile [1..1] Ice DefaultCandidate .....	101	Video DefaultPresentationSource .....	111	Video OSD WallpaperSelection .....	117
SIP Profile [1..1] Ice Mode .....	101	Video Input DVI [3]/[2,3] RGBQuantizationRange .....	112	Video Output Composite [3] MonitorRole .....	123
SIP Profile [1..1] Line .....	103	Video Input DVI [3]/[2,3] Type .....	112	Video Output Composite [3] OverscanLevel .....	123
SIP Profile [1..1] Mailbox .....	103	Video Input HDMI [1..2] RGBQuantizationRange .....	111	Video Output Composite [3] Resolution .....	123
SIP Profile [1..1] Outbound .....	103	Video Input Source [1..3] CameraControl Camerald .....	110	Video Output DVI [2] MonitorRole .....	122
SIP Profile [1..1] Proxy [1..4] Address .....	103	Video Input Source [1..3] CameraControl Mode .....	110	Video Output DVI [2] OverscanLevel .....	122
SIP Profile [1..1] Proxy [1..4] Discovery .....	103	Video Input Source [1..3] Name .....	109	Video Output DVI [2] Resolution .....	122
SIP Profile [1..1] TlsVerify .....	102	Video Input Source [1..3] OptimalDefinition Profile .....	110	Video Output DVI [2] RGBQuantizationRange .....	122
SIP Profile [1..1] Turn BandwidthProbe .....	101	Video Input Source [1..3] OptimalDefinition Threshold60fps .....	111	Video Output HDMI [1] CEC Mode .....	121
SIP Profile [1..1] Turn DiscoverMode .....	101	Video Input Source [1..3] PresentationSelection .....	110	Video Output HDMI [1] MonitorRole .....	121
SIP Profile [1..1] Turn DropRflx .....	101	Video Input Source [1..3] Quality .....	111	Video Output HDMI [1] OverscanLevel .....	121
SIP Profile [1..1] Turn Password .....	102	Video Input Source [1..3] Type .....	109	Video Output HDMI [1] Resolution .....	121
SIP Profile [1..1] Turn Server .....	101	Video Input Source [1] Connector .....	109	Video Output HDMI [1] RGBQuantizationRange .....	120
SIP Profile [1..1] Turn UserName .....	101	Video Input Source [2] Connector .....	109	Video Output HDMI [1] PresentationDefault Value Position .....	115
SIP Profile [1..1] Type .....	103	Video Input Source [3] Connector .....	109	Video Output HDMI [1] Selfview .....	113
SIP Profile [1..1] URI .....	102	Video Layout DisableDisconnectedLocalOutputs .....	116	Video Output HDMI [1] SelfviewController AutoResizing .....	113
<b>Standby settings</b> .....	<b>104</b>	Video Layout Engine LocalMode .....	116	Video Output HDMI [1] SelfviewDefault FullscreenMode .....	114
Standby BootAction .....	104	Video Layout LocalLayoutFamily .....	116	Video Output HDMI [1] SelfviewDefault Mode .....	114
Standby Control .....	104	Video Layout PresentationDefault View .....	116	Video Output HDMI [1] SelfviewDefault OnMonitorRole .....	114
Standby Delay .....	104	Video Layout RemoteLayoutFamily .....	117	Video Output HDMI [1] SelfviewDefault PIPPosition .....	114
Standby StandbyAction .....	104	Video Layout ScaleToFrame .....	113	Video Output HDMI [1] SelfviewPosition .....	113
Standby WakeupAction .....	104	Video Layout ScaleToFrameThreshold .....	113	Video Wallpaper .....	123
		Video Layout Scaling .....	112	<b>Experimental settings</b> .....	<b>124</b>

## Audio settings

### Audio Input HDMI [2] Mode

Determine if the audio channels on the HDMI input shall be enabled. The HDMI input 2 has two audio channels.

**Requires user role:** ADMIN

**Value space:** <Off/On>

*Off:* Disable audio on the HDMI input.

*On:* Enable audio on the HDMI input.

**Example:** Audio Input HDMI 2 Mode: On

### Audio Input HDMI [2] Level

Define the audio level of the HDMI input connector, in steps of 1 dB.

See the Audio Level tables in the Physical Interfaces Guide for the codec for a complete overview of the menu values represented in dB.

**Requires user role:** ADMIN

**Value space:** <-24..0>

*Range:* Select a value from -24 to 0 dB.

**Example:** Audio Input HDMI 2 Level: 0

### Audio Input HDMI [2] VideoAssociation MuteOnInactiveVideo

Enable association of a video source to an HDMI audio input.

**Requires user role:** ADMIN

**Value space:** <Off/On>

*Off:* No video source is associated.

*On:* A video source is associated, and the audio will be muted if the associated video source is not displayed.

**Example:** Audio Input HDMI 2 VideoAssociation MuteOnInactiveVideo: Off

### Audio Input HDMI [2] VideoAssociation VideoInputSource

Select the associated video input source.

**Requires user role:** ADMIN

**Value space:** <1/2/3>

*Range:* Select one of the video input sources.

**Example:** Audio Input HDMI 2 VideoAssociation VideoInputSource: 1

### Audio Input Line [1..2] Equalizer ID

Select the audio input line equalizer ID.

**Requires user role:** ADMIN

**Value space:** <1..8>

*Range:* Select EqualizerID 1 to 8.

**Example:** Audio Input Line 1 Equalizer ID: 1

### Audio Input Line [1..2] Equalizer Mode

Set the audio input line equalizer mode.

**Requires user role:** ADMIN

**Value space:** <Off/On>

*Off:* No equalizer.

*On:* Enable the equalizer for the audio input line.

**Example:** Audio Input Line 1 Equalizer Mode: Off

### Audio Input Line [1..2] VideoAssociation MuteOnInactiveVideo

Enable association of a video source to a Line audio input.

**Requires user role:** ADMIN

**Value space:** <Off/On>

*Off:* No video source is associated.

*On:* A video source is associated, and the audio will be muted if the associated video source is not displayed.

**Example:** Audio Input Line 1 VideoAssociation MuteOnInactiveVideo: Off

### Audio Input Line [1..2] VideoAssociation VideoInputSource

Select the associated video input source.

**Requires user role:** ADMIN

**Value space:** <1/2/3>

*Range:* Select one of the video input sources.

**Example:** Audio Input Line 1 VideoAssociation VideoInputSource: 1

### Audio Input Line [1..2] Channel

Define whether the Audio Line input is a mono signal or part of a multichannel signal.

**Requires user role:** ADMIN

**Value space:** <Right/Left/Mono>

*Right:* The Audio Line input signal is the right channel of a stereo signal.

*Left:* The Audio Line input signal is the left channel of a stereo signal.

*Mono:* The Audio Line input signal is a mono signal.

**Example:** Audio Input 1 Channel: Left

### Audio Input Line [1..2] Level

Define the audio level of the Line input connector, in steps of 1 dB.

See the Audio Level tables in the Physical Interfaces Guide for the codec for a complete overview of the menu values represented in dB.

**Requires user role:** ADMIN

**Value space:** <0..24>

*Range:* Select a value from 0 to 24 dB.

**Example:** Audio Input Line 1 Level: 10

### Audio Input Line [1..2] LoopSuppression

Codec C40 and C60 currently does not support loop suppression, hence it is always Off.

**Requires user role:** ADMIN

**Value space:** <Off>

*Off:* Deactivate Loop Suppression.

**Example:** Audio Input Line 1 LoopSuppression: Off

### Audio Input Line [1..2] Mode

Set the audio input line mode.

**Requires user role:** ADMIN

**Value space:** <Off/On>

*Off:* Disable the Audio Line input.

*On:* Enable the Audio Line input.

**Example:** Audio Input Line 1 Mode: On

### Audio Input Microphone [1..2]/[1..4] EchoControl Mode

NOTE: Codec C40 has two microphone connectors. Codec C60 has four microphone connectors.

The echo canceller continuously adjusts itself to the audio characteristics of the room and compensate for any changes it detects in the audio environment. If the changes in the audio conditions are very significant the echo canceller may take a second or two to re-adjust.

**Requires user role:** ADMIN

**Value space:** <Off/On>

*Off:* Echo Control should be switched Off if external echo cancellation or playback equipment is used.

*On:* Echo Control is normally set to On to prevent the far end from hearing their own audio. Once selected, echo cancellation is active at all times.

**Example:** Audio Input Microphone 1 EchoControl Mode: On

### Audio Input Microphone [1..2]/[1..4] EchoControl NoiseReduction

NOTE: Codec C40 has two microphone connectors. Codec C60 has four microphone connectors.

The system has a built-in noise reduction which reduces constant background noise (for example noise from air-conditioning systems, cooling fans etc.). In addition, a high pass filter (Humfilter) reduces very low frequency noise. NOTE: Requires the Echo Control Mode to be enabled for the microphone.

**Requires user role:** ADMIN

**Value space:** <Off/On>

*Off:* Turn off the Noise Reduction.

*On:* The Noise Reduction should be enabled in the presence of low frequency noise.

**Example:** Audio Input Microphone 1 EchoControl NoiseReduction: On

### Audio Input Microphone [1..2]/[1..4] EchoControl Dereverberation

NOTE: Codec C40 has two microphone connectors. Codec C60 has four microphone connectors.

The system has built-in signal processing to reduce the effect of room reverberation. NOTE: Requires the Echo Control Mode to be enabled for the microphone.

**Requires user role:** ADMIN

**Value space:** <Off/On>

*Off:* Turn off the dereverberation.

*On:* Turn on the dereverberation.

**Example:** Audio Input Microphone 1 EchoControl Dereverberation: On

### Audio Input Microphone [1..2]/[1..4] Equalizer ID

NOTE: Codec C40 has two microphone connectors. Codec C60 has four microphone connectors.

Select the audio input microphone equalizer ID.

**Requires user role:** ADMIN

**Value space:** <1..8>

*Range:* Select Equalizer ID 1 to 8.

**Example:** Audio Input Microphone 1 Equalizer ID: 1

### Audio Input Microphone [1..2]/[1..4] Equalizer Mode

NOTE: Codec C40 has two microphone connectors. Codec C60 has four microphone connectors.

Set the audio input microphone equalizer mode.

**Requires user role:** ADMIN

**Value space:** <Off/On>

*Off:* No equalizer.

*On:* Enable the equalizer for the audio input microphone.

**Example:** Audio Input Microphone 1 Equalizer Mode: Off

### Audio Input Microphone [1..2]/[1..4] VideoAssociation MuteOnInactiveVideo

NOTE: Codec C40 has two microphone connectors. Codec C60 has four microphone connectors.

Enable association of a video source to a microphone audio input.

**Requires user role:** ADMIN

**Value space:** <Off/On>

*Off:* No video source is associated.

*On:* A video source is associated, and the audio will be muted if the associated video source is not displayed.

**Example:** Audio Input Microphone 1 VideoAssociation MuteOnInactiveVideo: On

### Audio Input Microphone [1..2]/[1..4] VideoAssociation VideoInputSource

NOTE: Codec C40 has two microphone connectors. Codec C60 has four microphone connectors.

Select the associated video input source.

**Requires user role:** ADMIN

**Value space:** <1/2/3>

*Range:* Select one of the video input sources.

**Example:** Audio Input Microphone 1 VideoAssociation VideoInputSource: 1

### Audio Input Microphone [1..2]/[1..4] Level

NOTE: Codec C40 has two microphone connectors. Codec C60 has four microphone connectors.

Define the audio level of the Microphone input connector, in steps of 1 dB.

See the Audio Level tables in the Physical Interfaces Guide for the codec for a complete overview of the values represented in dB.

**Requires user role:** ADMIN

**Value space:** <0..24>

*Range:* Select a value from 0 to 24 dB.

**Example:** Audio Input Microphone 1 Level: 15

### Audio Input Microphone [1..2]/[1..4] Mode

NOTE: Codec C40 has two microphone connectors. Codec C60 has four microphone connectors.

Set the audio input microphone mode.

**Requires user role:** ADMIN

**Value space:** <Off/On>

*Off:* Disable the microphone connector.

*On:* Enable the microphone connector.

**Example:** Audio Input Microphone 1 Mode: On

### Audio Input Microphone [1..2]/[1..4] Type

NOTE: Codec C40 has two microphone connectors. Codec C60 has four microphone connectors.

The microphone connectors are intended for electret type microphones. The microphone connector can be set to line or microphone mode.

**Requires user role:** ADMIN

**Value space:** <Microphone/Line>

*Microphone:* Select Microphone when you have 48 V Phantom voltage and the pre-amplification is On.

*Line:* Select Line when you have a standard balanced line input. The phantom voltage and pre-amplification is Off.

**Example:** Audio Input Microphone 1 Type: Line

### Audio Output HDMI [1] Level

Define the output level of the HDMI output connector, in steps of 1 dB.

See the Audio Level tables in the Physical Interfaces Guide for the codec for a complete overview of the menu values represented in dB.

**Requires user role:** ADMIN

**Value space:** <-24..0>

*Range:* Select a value from -24 to 0dB.

**Example:** Audio Output HDMI 1 Level: 0

### Audio Output HDMI [1] Mode

Determine if the audio channel on the HDMI output connector shall be enabled.

**Requires user role:** ADMIN

**Value space:** <Off/On>

*Off:* Disable the audio channel on the HDMI output.

*On:* Enable the audio channel on the HDMI output.

**Example:** Audio Output HDMI 1 Mode: On

### Audio Output Line [1..2] Channel

Define whether the Audio Line output is a mono signal or part of a multichannel signal.

**Requires user role:** ADMIN

**Value space:** <Right/Left/Mono>

*Right:* The Audio Line output signal is the right channel of a stereo signal.

*Left:* The Audio Line output signal is the left channel of a stereo signal.

*Mono:* The Audio Line output signal is a mono signal.

**Example:** Audio Output Line 1 Channel: left

### Audio Output Line [1..2] Equalizer ID

Select the audio output line equalizer ID.

**Requires user role:** ADMIN

**Value space:** <1..8>

*Range:* Select EqualizerID 1 to 8.

**Example:** Audio Output Line 1 Equalizer ID: 1

### Audio Output Line [1..2] Equalizer Mode

Set the audio output line equalizer mode.

**Requires user role:** ADMIN

**Value space:** <Off/On>

*Off:* No equalizer.

*On:* Enable the equalizer for the audio output line.

**Example:** Audio Output Line 1 Equalizer Mode: Off

### Audio Output Line [1..2] Level

Define the output level of the Audio Output Line connector, in steps of 1 dB.

See the Audio Level tables in the Physical Interfaces Guide for the codec for a complete overview of the menu values represented in dB.

**Requires user role:** ADMIN

**Value space:** <-24..0>

*Range:* Select a value from -24 to 0 dB.

**Example:** Audio Output Line 1 Level: -10

### Audio Output Line [1..2] Mode

Set the audio output line mode.

**Requires user role:** ADMIN

**Value space:** <Off/On>

*Off:* Disable the Audio Line output.

*On:* Enable the Audio Line output.

**Example:** Audio Output Line 1 Mode: On

### Audio Output Line [1] Type

Determine if the Audio Line output will be analog or digital type output. The digital output on the Cisco TelePresence Profile systems are identified as DNAM (Digital Natural Audio Module).

**Requires user role:** ADMIN

**Value space:** <Auto/SPDIF>

*Auto:* If a Digital NAM is detected then SPDIF mode will be selected, otherwise analog mode will be selected.

*SPDIF:* Set to SPDIF when you want the line output to be in digital mode.

**Example:** Audio Output Line 1 Type: Auto



### Audio Output Line [2] Type

Line output 2 is a dedicated analog output, hence type can be set to analog only.

**Requires user role:** ADMIN

**Value space:** <Analog>

*Analog:* Can be set to analog only.

**Example:** Audio Output Line 2 Type: Analog

### Audio Microphones Mute Enabled

Determine whether audio-mute is allowed or not. The default value is True.

**Requires user role:** ADMIN

**Value space:** <True/InCallOnly>

*True:* Muting of audio is always available.

*InCallOnly:* Muting of audio is only available when the device is in a call. When Idle it is not possible to mute the microphone. This is useful when an external telephone service/audio system is connected via the codec and is to be available when the codec is not in a call. When set to InCallOnly this will prevent the audio-system from being muted by mistake.

**Example:** Audio Microphones Mute Enabled: True

### Audio SoundsAndAlerts KeyTones Mode

The system can be configured to make a keyboard click sound effect (key tone) when pressing a key on the remote control, or when typing text or numbers on a Touch controller.

**Requires user role:** USER

**Value space:** <Off/On>

*Off:* No key tones will be played when you type.

*On:* You will hear a key tone when you press a key or type text.

**Example:** Audio SoundsAndAlerts KeyTones Mode: Off

### Audio SoundsAndAlerts RingTone

Select the ring tone for incoming calls.

**Requires user role:** USER

**Value space:** <Marbles/IceCrystals/Polaris/Alert/Discreet/Fantasy/Jazz/Nordic/Echo/Rhythmic>

*Range:* Select a tone from the list of ring tones.

**Example:** Audio SoundsAndAlerts RingTone: Jazz

### Audio SoundsAndAlerts RingVolume

Sets the ring volume for an incoming call.

**Requires user role:** USER

**Value space:** <0..100>

*Range:* The value goes in steps of 5 from 0 to 100 (from -34.5 dB to 15 dB). Volume 0 = Off.

**Example:** Audio SoundsAndAlerts RingVolume: 50

### Audio Volume

Adjust the speaker volume.

**Requires user role:** USER

**Value space:** <0..100>

*Range:* The value must be between 0 and 100. The values from 1 to 100 correspond to the range from -34.5 dB to 15 dB (0.5 dB steps). The value 0 means that the audio is switched off.

**Example:** Audio Volume: 70

## Cameras settings

### Cameras Camera [1..7] Backlight

This configuration turns backlight compensation on or off. Backlight compensation is useful when there is much light behind the persons in the room. Without compensation the persons will easily appear very dark to the far end.

**Requires user role:** ADMIN

**Value space:** <Off/On>

*Off:* Turn off the camera backlight compensation.

*On:* Turn on the camera backlight compensation.

**Example:** Cameras Camera 1 Backlight: Off

### Cameras Camera [1..7] Brightness Mode

Set the camera brightness mode.

**Requires user role:** ADMIN

**Value space:** <Auto/Manual>

*Auto:* The camera brightness is automatically set by the system.

*Manual:* Enable manual control of the camera brightness. The brightness level is set using the Cameras Camera Brightness Level setting.

**Example:** Cameras Camera 1 Brightness Mode: Auto

### Cameras Camera [1..7] Brightness Level

Set the brightness level. NOTE: Requires the Camera Brightness Mode to be set to Manual.

**Requires user role:** ADMIN

**Value space:** <1..31>

*Range:* Select a value from 1 to 31.

**Example:** Cameras Camera 1 Brightness Level: 1

### Cameras Camera [1..7] Flip

With Flip mode (vertical flip) you can flip the image upside down.

**Requires user role:** ADMIN

**Value space:** <Auto/Off/On>

*Auto:* When the camera is placed upside down the image is automatically flipped upside down. This setting will only take effect for a camera that automatically detects which way it is mounted.

*Off:* Display the video on screen the normal way.

*On:* When enabled the video on screen is flipped. This setting is used when a camera is mounted upside down, but cannot automatically detect which way it is mounted.

**Example:** Cameras Camera 1 Flip: Off

### Cameras Camera [1..7] Focus Mode

Set the camera focus mode.

**Requires user role:** ADMIN

**Value space:** <Auto/Manual>

*Auto:* The camera will auto focus once a call is connected, as well as after moving the camera (pan, tilt, zoom). The system will use auto focus only for a few seconds to set the right focus; then auto focus is turned off to prevent continuous focus adjustments of the camera.

*Manual:* Turn the autofocus off and adjust the camera focus manually.

**Example:** Cameras Camera 1 Focus Mode: Auto

### Cameras Camera [1..7] Gamma Mode

Applies to cameras which support gamma mode. The Gamma Mode setting enables for gamma corrections. Gamma describes the nonlinear relationship between image pixels and monitor brightness. The Cisco TelePresence PrecisionHD 720p camera supports gamma mode. The PrecisionHD 1080p camera does not support gamma mode.

**Requires user role:** ADMIN

**Value space:** <Auto/Manual>

*Auto:* Auto is the default and the recommended setting.

*Manual:* In severe light conditions, you may switch mode to manual and specify explicitly which gamma table to use by setting the Gamma Level.

**Example:** Cameras Camera 1 Gamma Mode: Auto

### Cameras Camera [1..7] Gamma Level

By setting the Gamma Level you can select which gamma correction table to use. This setting may be useful in difficult lighting conditions, where changes to the brightness setting does not provide satisfactory results. NOTE: Requires the Gamma Mode to be set to Manual.

**Requires user role:** ADMIN

**Value space:** <0..7>

*Range:* Select a value from 0 to 7.

**Example:** Cameras Camera 1 Gamma Level: 0

### Cameras Camera [1..7] IrSensor

The IR sensor LED is located in the front of the camera and flickers when the IR sensor is activated from the remote control. Both the Codec C Series and PrecisionHD camera have IR sensors, and only one of them needs to be enabled at the time.

**Requires user role:** ADMIN

**Value space:** <Off/On>

*Off:* Disable the IR sensor on the camera.

*On:* Enable the IR sensor on the camera.

**Example:** Cameras Camera 1 IrSensor: On

### Cameras Camera [1..7] Mirror

With Mirror mode (horizontal flip) you can mirror the image on screen.

**Requires user role:** ADMIN

**Value space:** <Auto/Off/On>

*Auto:* When the camera is placed upside down the image is automatically mirrored. Use this setting with cameras that can be mounted upside down, and that can auto detect that the camera is mounted upside down.

*Off:* See the self view in normal mode, that is the experience of self view is as seeing yourself as other people see you.

*On:* See the self view in mirror mode, that is the self view is reversed and the experience of self view is as seeing yourself in a mirror.

**Example:** Cameras Camera 1 Mirror: Off

### Cameras Camera [1..7] MotorMoveDetection

This setting applies only when using a Cisco TelePresence PrecisionHD 1080p12x camera.

If adjusting the camera position by hand you can configure whether the camera should keep its new position or return to the preset or position it had before.

**Requires user role:** ADMIN

**Value space:** <Off/On>

*Off:* When the camera position is adjusted manually the camera will keep this position until adjusted again. WARNING: If moving the camera by hand, the camera will not register the new pan and tilt values since there is no position feedback. This will result in wrong pan and tilt values when recalling the camera presets subsequently.

*On:* When the camera position is adjusted manually, or the camera detects that the motors have moved, it will first re-initialize (i.e. go to default position) then return to the preset/ position it had before the camera was adjusted.

**Example:** Cameras Camera 1 MotorMoveDetection: Off

## Cameras Camera [1..7] Whitebalance Mode

Set the camera whitebalance mode.

**Requires user role:** ADMIN

**Value space:** <Auto/Manual>

*Auto:* The camera will continuously adjust the whitebalance depending on the camera view.

*Manual:* Enables manual control of the camera whitebalance. The whitebalance level is set using the Cameras Camera Whitebalance Level setting.

**Example:** Cameras Camera 1 Whitebalance Mode: Auto

## Cameras Camera [1..7] Whitebalance Level

Set the whitebalance level. NOTE: Requires the Camera Whitebalance Mode to be set to manual.

**Requires user role:** ADMIN

**Value space:** <1..16>

*Range:* Select a value from 1 to 16.

**Example:** Cameras Camera 1 Whitebalance Level: 1

## Cameras Camera [1..7] DHCP

Applies to cameras which support DHCP (for example the Cisco TelePresence PrecisionHD 1080p 12X camera). The camera must be connected to a LAN. When set, the command enables support for SW upgrade of daisy chained cameras. It will enable the camera's DHCP function and force start of MAC and IP address retrieval. Remember to reset the DHCP when the camera is no longer connected to a LAN.

**Requires user role:** ADMIN

**Value space:** <Off/On>

*Off:* Disable DHCP in the camera. NOTE: This setting should be applied when the camera is not connected to a LAN.

*On:* Enable DHCP in the camera. The camera is automatically re-booted. After re-boot the DHCP is started and the IP address will be retrieved. Run the command "xStatus Camera" for result.

**Example:** Cameras Camera 1 DHCP: Off

## Conference settings

### Conference [1..1] CallProtocolIPStack

Select if the system should enable IPv4, IPv6, or dual IP stack on the call protocol (SIP, H323).

**Requires user role:** ADMIN

**Value space:** <Dual/IPv4/IPv6>

*Dual:* Enables both IPv4 and IPv6 for H323 and SIP calls.

*IPv4:* When set to IPv4, the call protocol (SIP, H323) will use IPv4.

*IPv6:* When set to IPv6, the call protocol (SIP, H323) will use IPv6.

**Example:** Conference 1 CallProtocolIPStack: Dual

### Conference [1..1] AutoAnswer Mode

Set the auto answer mode.

**Requires user role:** ADMIN

**Value space:** <Off/On>

*Off:* An incoming call must be answered manually by pressing the OK key or the green Call key on the remote control, or by tapping the Accept key on the Touch controller.

*On:* Enable auto answer to let the system automatically answer all incoming calls.

**Example:** Conference 1 AutoAnswer Mode: Off

### Conference [1..1] AutoAnswer Mute

Determine if the microphone shall be muted when an incoming call is automatically answered.

NOTE: Requires that AutoAnswer Mode is switched on.

**Requires user role:** ADMIN

**Value space:** <Off/On>

*Off:* The incoming call will not be muted.

*On:* The incoming call will be muted when automatically answered.

**Example:** Conference 1 AutoAnswer Mute: Off

### Conference [1..1] AutoAnswer Delay

Define how long (in seconds) an incoming call has to wait before it is answered automatically by the system. NOTE: Requires that AutoAnswer Mode is switched on.

**Requires user role:** ADMIN

**Value space:** <0..50>

*Range:* Select a value from 0 to 50 seconds.

**Example:** Conference 1 AutoAnswer Delay: 0

### Conference [1..1] MicUnmuteOnDisconnect Mode

Determine if the microphones shall be unmuted automatically when all calls are disconnected. In a meeting room or other shared resources this may be done to prepare the system for the next user.

**Requires user role:** ADMIN

**Value space:** <Off/On>

*Off:* If muted during a call, let the microphones remain muted after the call is disconnected.

*On:* Unmute the microphones after the call is disconnected.

**Example:** Conference 1 MicUnmuteOnDisconnect Mode: On

### Conference [1..1] DoNotDisturb Mode

Determine if there should be an alert on incoming calls.

**Requires user role:** USER

**Value space:** <Off/On/Timed>

*Off:* The incoming calls will come through as normal.

*On:* All incoming calls will be rejected and they will be registered as missed calls. The calling side will receive a busy signal. A message telling that Do Not Disturb is switched on will display on the Touch controller or main display. The calls received while in Do Not Disturb mode will be shown as missed calls.

*Timed:* Select this option only if using the API to switch Do Not Disturb mode on and off (xCommand Conference DoNotDisturb Activate and xCommand Conference DoNotDisturb Deactivate).

**Example:** Conference 1 DoNotDisturb Mode: Off

### Conference [1..1] DoNotDisturb DefaultTimeout

This setting determines the default duration of a Do Not Disturb session, i.e. the period when incoming calls are rejected and registered as missed calls. The session can be terminated earlier by using the user interface (remote control or Touch controller) or the Conference DoNotDisturb Mode setting. The default value is 60 minutes.

**Requires user role:** ADMIN

**Value space:** <0..1440>

*Range:* Select the number of minutes (between 0 and 1440, i.e. 24 hours) before the Do Not Disturb session times out automatically.

**Example:** Conference 1 DoNotDisturb DefaultTimeOut: 60

### Conference [1..1] FarEndControl Mode

Lets you decide if the remote side (far end) should be allowed to select your video sources and control your local camera (pan, tilt, zoom).

**Requires user role:** ADMIN

**Value space:** <Off/On>

*Off:* The far end is not allowed to select your video sources or to control your local camera (pan, tilt, zoom).

*On:* Allows the far end to be able to select your video sources and control your local camera (pan, tilt, zoom). You will still be able to control your camera and select your video sources as normal.

**Example:** Conference 1 FarEndControl Mode: On

### Conference [1..1] FarEndControl SignalCapability

Set the far end control (H.224) signal capability mode.

**Requires user role:** ADMIN

**Value space:** <Off/On>

*Off:* Disable the far end control signal capability.

*On:* Enable the far end control signal capability.

**Example:** Conference 1 FarEndControl SignalCapability: On

### Conference [1..1] Encryption Mode

Set the conference encryption mode. A padlock with the text "Encryption On" or "Encryption Off" displays on screen for a few seconds when the conference starts.

**Requires user role:** ADMIN

**Value space:** <Off/On/BestEffort>

*Off:* The system will not use encryption.

*On:* The system will only allow calls that are encrypted.

*BestEffort:* The system will use encryption whenever possible.

> *In Point to point calls:* If the far end system supports encryption (AES-128), the call will be encrypted. If not, the call will proceed without encryption.

> *In MultiSite calls:* In order to have encrypted MultiSite conferences, all sites must support encryption. If not, the conference will be unencrypted.

**Example:** Conference 1 Encryption Mode: BestEffort

### Conference [1..1] DefaultCall Protocol

Set the Default Call Protocol to be used when placing calls from the system.

**Requires user role:** ADMIN

**Value space:** <Auto/H323/Sip/H320>

*Auto:* Enables auto-selection of the call protocol based on which protocols are available. If multiple protocols are available, the order of priority is: 1) SIP; 2) H323; 3) H320. If the system cannot register, or the call protocol is not enabled, the auto-selection chooses H323.

*H323:* H323 ensures that calls are set up as H.323 calls.

*Sip:* Sip ensures that calls are set up as SIP calls.

*H320:* H320 ensures that calls are set up as H.320 calls (only applicable if connected to a Cisco TelePresence ISDN Link gateway).

**Example:** Conference 1 DefaultCall Protocol: H323

### Conference [1..1] DefaultCall Rate

Set the Default Call Rate to be used when placing calls from the system.

**Requires user role:** ADMIN

**Value space:** <64..6000>

*Range:* Select a value between 64 and 6000 kbps.

**Example:** Conference 1 DefaultCall Rate: 768

### Conference [1..1] MaxTransmitCallRate

Specify the maximum transmit bit rate to be used when placing or receiving calls. Note that this is the maximum bit rate for each individual call; use the Conference MaxTotalTransmitCallRate setting to set the aggregated maximum for all simultaneous active calls.

**Requires user role:** ADMIN

**Value space:** <64..6000>

*Range:* Select a value between 64 and 6000 kbps.

**Example:** Conference 1 MaxTransmitCallRate: 6000

### Conference [1..1] MaxReceiveCallRate

Specify the maximum receive bit rate to be used when placing or receiving calls. Note that this is the maximum bit rate for each individual call; use the Conference MaxTotalReceiveCallRate setting to set the aggregated maximum for all simultaneous active calls.

**Requires user role:** ADMIN

**Value space:** <64..6000>

*Range:* Select a value between 64 and 6000 kbps.

**Example:** Conference 1 MaxReceiveCallRate: 6000

### Conference [1..1] MaxTotalTransmitCallRate

This configuration applies when using a video system's built-in MultiSite feature (optional) to host a multipoint video conference.

Specify the maximum overall transmit bit rate allowed. The bit rate will be divided fairly among all active calls at any time. This means that the individual calls will be up-speeded or down-speeded as appropriate when someone leaves or enters a multipoint conference, or when a call is put on hold (suspended) or resumed.

The maximum transmit bit rate for each individual call is defined in the Conference MaxTransmitCallRate setting.

**Requires user role:** ADMIN

**Value space:** <64..10000>

*Range:* Select a value between 64 and 10000.

**Example:** Conference 1 MaxTotalTransmitCallRate: 9000

### Conference [1..1] MaxTotalReceiveCallRate

This configuration applies when using a video system's built-in MultiSite feature (optional) to host a multipoint video conference.

Specify the maximum overall receive bit rate allowed. The bit rate will be divided fairly among all active calls at any time. This means that the individual calls will be up-speeded or down-speeded as appropriate when someone leaves or enters a multipoint conference, or when a call is put on hold (suspended) or resumed.

The maximum receive bit rate for each individual call is defined in the Conference MaxReceiveCallRate setting.

**Requires user role:** ADMIN

**Value space:** <64..10000>

*Range:* Select a value between 64 and 10000.

**Example:** Conference 1 MaxTotalReceiveCallRate: 9000

### Conference [1..1] VideoBandwidth Mode

Set the conference video bandwidth mode.

**Requires user role:** ADMIN

**Value space:** <Dynamic/Static>

*Dynamic:* The available transmit bandwidth for the video channels are distributed among the currently active channels. If there is no presentation, the main video channels will use the bandwidth of the presentation channel.

*Static:* The available transmit bandwidth is assigned to each video channel, even if it is not active.

**Example:** Conference 1 VideoBandwidth Mode: Dynamic

### Conference [1..1] VideoBandwidth MainChannel Weight

The available transmit video bandwidth is distributed on the main channel and presentation channel according to "MainChannel Weight" and "PresentationChannel Weight". If the main channel weight is 2 and the presentation channel weight is 1, then the main channel will use twice as much bandwidth as the presentation channel.

**Requires user role:** ADMIN

**Value space:** <1..10>

*Range:* 1 to 10.

**Example:** Conference 1 VideoBandwidth MainChannel Weight: 5

### Conference [1..1] VideoBandwidth PresentationChannel Weight

The available transmit video bandwidth is distributed on the main channel and presentation channel according to "MainChannel Weight" and "PresentationChannel Weight". If the main channel weight is 2 and the presentation channel weight is 1, then the main channel will use twice as much bandwidth as the presentation channel.

**Requires user role:** ADMIN

**Value space:** <1..10>

*Range:* 1 to 10.

**Example:** Conference 1 VideoBandwidth PresentationChannel Weight: 5

### Conference [1..1] Presentation Policy

Control how the presentation service is to be performed.

**Requires user role:** ADMIN

**Value space:** <LocalRemote/LocalOnly>

*LocalRemote:* The presentation will be shown locally and sent to remote side.

*LocalOnly:* The presentation will only be shown locally.

**Example:** Conference 1 Presentation Policy: LocalRemote

### Conference [1..1] Presentation RelayQuality

This configuration applies to video systems that are using the built-in MultiSite feature (optional) to host a multipoint video conference. When a remote user shares a presentation, the video system (codec) will transcode the presentation and send it to the other participants in the multipoint conference. The RelayQuality setting specifies whether to give priority to high frame rate or to high resolution for the presentation source.

**Requires user role:** ADMIN

**Value space:** <Motion/Sharpness>

*Motion:* Gives the highest possible frame rate. Used when there is a need for higher frame rates, typically when there is a lot of motion in the picture.

*Sharpness:* Gives the highest possible resolution. Used when you want the highest quality of detailed images and graphics.

**Example:** Conference 1 Presentation RelayQuality: Sharpness

### Conference [1..1] Presentation OnPlacedOnHold

Define whether or not to continue sharing a presentation after the remote site has put you on hold.

**Requires user role:** ADMIN

**Value space:** <Stop/NoAction>

*Stop:* The video system stops the presentation sharing when the remote site puts you on hold. The presentation will not continue when the call is resumed.

*NoAction:* The video system will not stop the presentation sharing when put on hold. The presentation will not be shared while you are on hold, but it will continue automatically when the call is resumed.

**Example:** Conference 1 Presentation OnPlacedOnHold: NoAction



## Conference [1..1] Multipoint Mode

Define how the video system handles multiparty video conferences.

If registered to a Cisco TelePresence Video Communication Server (VCS), the video system can either use its own built-in MultiSite feature, or it can rely on the MultiWay network solution. MultiWay requires that the video network includes a multipoint control unit (MCU).

If registered to a Cisco Unified Communications Manager (CUCM) version 8.6.2 or newer, the video system can use either the CUCM conference bridge, or the video system's own built-in MultiSite feature. Which one to use is set-up by CUCM.

Both Multiway and the CUCM conference bridge allows you to set up conferences with many participants. The MultiSite feature allows up to four participants (yourself included) plus one additional audio call.

Note that the MultiSite feature is optional and may not be available on all video systems.

**Requires user role:** ADMIN

**Value space:** <Auto/Off/MultiSite/MultiWay/CUCMMediaResourceGroupList>

*Auto:* If a MultiWay address is specified in the NetworkServices MultiWay Address setting, MultiWay takes priority over MultiSite. If neither MultiWay nor MultiSite is available, the Multipoint Mode is set to Off automatically.

*Off:* Multiparty conferences are not allowed.

*MultiSite:* Multiparty conferences are set up using MultiSite. If MultiSite is chosen when the MultiSite feature is not available, the Multipoint Mode will be set to Off.

*MultiWay:* Multiparty conferences are set up using MultiWay. The Multipoint Mode will be set to Off automatically if the MultiWay service is unavailable, for example if a server address is not specified in the NetworkServices MultiWay Address setting.

*CUCMMediaResourceGroupList:* Multiparty conferences (ad hoc conferences) are hosted by the CUCM configured conference bridge. This setting is provisioned by CUCM in a CUCM environment and should never be set manually by the user.

**Example:** Conference 1 Multipoint Mode: Auto

## Conference [1..1] IncomingMultisiteCall Mode

Select whether or not to allow incoming calls when already in a call/conference.

**Requires user role:** ADMIN

**Value space:** <Allow/Deny>

*Allow:* You will be notified when someone calls you while you are already in a call. You can accept the incoming call or not. The ongoing call may be put on hold while answering the incoming call; or you may merge the calls (requires MultiSite or MultiWay support).

*Deny:* An incoming call will be rejected if you are already in a call. You will not be notified about the incoming call. However, the call will appear as a missed call in the call history list.

**Example:** Conference 1 IncomingMultisiteCall Mode: Allow

## FacilityService settings

### FacilityService Service [1..5] Type

Up to five different facility services can be supported simultaneously. With this setting you can select what kind of services they are.

A facility service is not available unless both the FacilityService Service Name and the FacilityService Service Number settings are properly set.

Only FacilityService Service 1 with Type Helpdesk is available on the Touch controller. Facility services are not available when using the remote control and on-screen menu.

**Requires user role:** ADMIN

**Value space:** <Other/Concierge/Helpdesk/Emergency/Security/Catering/Transportation>

*Other:* Select this option for services not covered by the other options.

*Concierge:* Select this option for concierge services.

*Helpdesk:* Select this option for helpdesk services.

*Emergency:* Select this option for emergency services.

*Security:* Select this option for security services.

*Catering:* Select this option for catering services.

*Transportation:* Select this option for transportation services.

**Example:** FacilityService Service 1 Type: Helpdesk

### FacilityService Service [1..5] Name

Set the name of each facility service. Up to five different facility services are supported.

A facility service is not available unless both the FacilityService Service Name and the FacilityService Service Number settings are properly set.

Only FacilityService Service 1 is available on the Touch controller, and its Name is used on the facility service call button. Facility services are not available when using the remote control and on-screen menu.

**Requires user role:** ADMIN

**Value space:** <S: 0, 255>

*Format:* String with a maximum of 255 characters.

**Example:** FacilityService Service 1 Name: ""

### FacilityService Service [1..5] Number

Set the number for each facility service. Up to five different facility services are supported.

A facility service is not available unless both the FacilityService Service Name and the FacilityService Service Number settings are properly set.

Only FacilityService Service 1 is available on the Touch controller. Facility services are not available when using the remote control and on-screen menu.

**Requires user role:** ADMIN

**Value space:** <S: 0, 255>

*Format:* String with a maximum of 255 characters.

**Example:** FacilityService Service 1 Number: ""

### FacilityService Service [1..5] CallType

Set the call type for each facility service. Up to five different facility services are supported.

A facility service is not available unless both the FacilityService Service Name and the FacilityService Service Number settings are properly set.

Only FacilityService Service 1 is available on the Touch controller. Facility services are not available when using the remote control and on-screen menu.

**Requires user role:** ADMIN

**Value space:** <Video/Audio>

*Video:* Select this option for video calls.

*Audio:* Select this option for audio calls.

**Example:** FacilityService Service 1 CallType: Video

## GPIO settings

### GPIO Pin [1..4] Mode

NOTE: This command is not supported on Codec C40.

The four GPIO pins are configured individually. The state can be retrieved by "xStatus GPIO Pin [1..4] State". The default pin state is High (+12 V). When activated as output, they are set to 0 V. To activate them as input, they must be pulled down to 0 V.

**Requires user role:** ADMIN

**Value space:** <InputNoAction/OutputManualState/OutputInCall/OutputMicrophonesMuted/OutputPresentationOn/OutputAllCallsEncrypted/OutputStandbyActive/InputMuteMicrophones>

*InputNoAction:* The pin state can be set, but no operation is performed.

*OutputManualState:* The pin state can be set by "xCommand GPIO ManualState Set PinX: <High/Low>" (to +12 V or 0 V, respectively).

*OutputInCall:* The pin is activated when in call, deactivated when not in call.

*OutputMicrophonesMuted:* The pin is activated when microphones are muted, deactivated when not muted.

*OutputPresentationOn:* The pin is activated when presentation is active, deactivated when presentation is not active.

*OutputAllCallsEncrypted:* The pin is activated when all calls are encrypted, deactivated when one or more calls are not encrypted.

*OutputStandbyActive:* The pin is activated when the system is in standby mode, deactivated when no longer in standby.

*InputMuteMicrophones:* When the pin is activated (0 V), the microphones will be muted. When deactivated (+ 12 V), the microphones are unmuted.

**Example:** GPIO Pin 1 Mode: InputNoAction

## H323 settings

### H323 NAT Mode

The firewall traversal technology creates a secure path through the firewall barrier, and enables proper exchange of audio/video data when connected to an external video conferencing system (when the IP traffic goes through a NAT router). NOTE: NAT does not work in conjunction with gatekeepers.

**Requires user role:** ADMIN

**Value space:** <Auto/Off/On>

*Auto:* The system will determine if the H323 NAT Address or the real IP address should be used in signaling. This makes it possible to place calls to endpoints on the LAN as well as endpoints on the WAN. If the H323 NAT Address is wrong or not set, the real IP address will be used.

*Off:* The system will signal the real IP address.

*On:* The system will signal the configured H323 NAT Address instead of its real IP address in Q.931 and H.245. The NAT Server Address will be shown in the startup-menu as: "My IP Address: 10.0.2.1". If the H323 NAT Address is wrong or not set, H.323 calls cannot be set up.

**Example:** H323 NAT Mode: Off

### H323 NAT Address

Enter the external/global IP address to the router with NAT support. Packets sent to the router will then be routed to the system. Note that NAT cannot be used when registered to a gatekeeper.

In the router, the following ports must be routed to the system's IP address:

- \* Port 1720
- \* Port 5555-6555
- \* Port 2326-2487

**Requires user role:** ADMIN

**Value space:** <S: 0, 64>

*Format:* A valid IPv4 address or IPv6 address.

**Example:** H323 NAT Address: ""

### H323 Profile [1..1] Authentication Mode

Set the authentication mode for the H.323 profile.

**Requires user role:** ADMIN

**Value space:** <Off/On>

*Off:* If the H.323 Gatekeeper Authentication Mode is set to Off the system will not try to authenticate itself to a H.323 Gatekeeper, but will still try a normal registration.

*On:* If the H.323 Gatekeeper Authentication Mode is set to On and a H.323 Gatekeeper indicates that it requires authentication, the system will try to authenticate itself to the gatekeeper. NOTE: Requires the Authentication LoginName and Authentication Password to be defined on both the codec and the Gatekeeper.

**Example:** H323 Profile 1 Authentication Mode: Off

### H323 Profile [1..1] Authentication LoginName

The system sends the Authentication Login Name and the Authentication Password to a H.323 Gatekeeper for authentication. The authentication is a one way authentication from the codec to the H.323 Gatekeeper, i.e. the system is authenticated to the gatekeeper. If the H.323 Gatekeeper indicates that no authentication is required, the system will still try to register. NOTE: Requires the H.323 Gatekeeper Authentication Mode to be enabled.

**Requires user role:** ADMIN

**Value space:** <S: 0, 50>

*Format:* String with a maximum of 50 characters.

**Example:** H323 Profile 1 Authentication LoginName: ""

### H323 Profile [1..1] Authentication Password

The system sends the Authentication Login Name and the Authentication Password to a H.323 Gatekeeper for authentication. The authentication is a one way authentication from the codec to the H.323 Gatekeeper, i.e. the system is authenticated to the gatekeeper. If the H.323 Gatekeeper indicates that no authentication is required, the system will still try to register. NOTE: Requires the H.323 Gatekeeper Authentication Mode to be enabled.

**Requires user role:** ADMIN

**Value space:** <S: 0, 50>

*Format:* String with a maximum of 50 characters.

**Example:** H323 Profile 1 Authentication Password: ""

### H323 Profile [1..1] CallSetup Mode

The H.323 Call Setup Mode defines whether to use a Gatekeeper or Direct calling when establishing H323 calls.

NOTE: Direct H.323 calls can be made even though the H.323 Call Setup Mode is set to Gatekeeper.

**Requires user role:** ADMIN

**Value space:** <Direct/Gatekeeper>

*Direct:* An IP address must be used when dialing in order to make the H323 call.

*Gatekeeper:* The system will use a Gatekeeper to make a H.323 call. When selecting this option the H323 Profile Gatekeeper Address and H323 Profile Gatekeeper Discovery settings must also be configured.

**Example:** H323 Profile 1 CallSetup Mode: Gatekeeper

### H323 Profile [1..1] Gatekeeper Discovery

Determine how the system shall register to a H.323 Gatekeeper.

**Requires user role:** ADMIN

**Value space:** <Manual/Auto>

*Manual:* The system will use a specific Gatekeeper identified by the Gatekeeper's IP address.

*Auto:* The system will automatically try to register to any available Gatekeeper. If a Gatekeeper responds to the request sent from the codec within 30 seconds this specific Gatekeeper will be used. This requires that the Gatekeeper is in auto discovery mode as well. If no Gatekeeper responds, the system will not use a Gatekeeper for making H.323 calls and hence an IP address must be specified manually.

**Example:** H323 Profile 1 Gatekeeper Discovery: Manual

### H323 Profile [1..1] Gatekeeper Address

Enter the IP address of the Gatekeeper. NOTE: Requires the H.323 Call Setup Mode to be set to Gatekeeper and the Gatekeeper Discovery to be set to Manual.

**Requires user role:** ADMIN

**Value space:** <S: 0, 255>

*Format:* A valid IPv4 address, IPv6 address or DNS name.

**Example:** H323 Profile 1 Gatekeeper Address: "192.0.2.0"

### H323 Profile [1..1] H323Alias E164

The H.323 Alias E.164 defines the address of the system, according to the numbering plan implemented in the H.323 Gatekeeper. The E.164 alias is equivalent to a telephone number, sometimes combined with access codes.

**Requires user role:** ADMIN

**Value space:** <S: 0, 30>

*Format:* Compact string with a maximum of 30 characters. Valid characters are 0-9, \* and #.

**Example:** H323 Profile 1 H323Alias E164: "90550092"

### H323 Profile [1..1] H323Alias ID

Lets you specify the H.323 Alias ID which is used to address the system on a H.323 Gatekeeper and will be displayed in the call lists. Example: "firstname.lastname@company.com", "My H.323 Alias ID"

**Requires user role:** ADMIN

**Value space:** <S: 0, 49>

*Format:* String with a maximum of 49 characters.

**Example:** H323 Profile 1 H323Alias ID: "firstname.lastname@company.com"

### H323 Profile [1..1] PortAllocation

The H.323 Port Allocation setting affects the H.245 port numbers used for H.323 call signalling.

**Requires user role:** ADMIN

**Value space:** <Dynamic/Static>

*Dynamic:* The system will allocate which ports to use when opening a TCP connection. The reason for doing this is to avoid using the same ports for subsequent calls, as some firewalls consider this as a sign of attack. When Dynamic is selected, the H.323 ports used are from 11000 to 20999. Once 20999 is reached they restart again at 11000. For RTP and RTCP media data, the system is using UDP ports in the range 2326 to 2487. Each media channel is using two adjacent ports, ie 2330 and 2331 for RTP and RTCP respectively. The ports are automatically selected by the system within the given range. Firewall administrators should not try to deduce which ports are used when, as the allocation schema within the mentioned range may change without any further notice.

*Static:* When set to Static the ports are given within a static predefined range [5555-6555].

**Example:** H323 Profile 1 PortAllocation: Dynamic



## Logging settings

### Logging Mode

Not applicable in this version.

## Network settings

### Network [1..1] IPStack

Select if the sFSystem should use IPv4, IPv6, or dual IP stack, on the network interface. NOTE: After changing this setting you may have to wait up to 30 seconds before it takes effect.

**Requires user role:** ADMIN

**Value space:** <Dual/IPv4/IPv6>

*Dual:* When set to Dual, the network interface can operate on both IP versions at the same time, and can have both an IPv4 and an IPv6 address at the same time.

*IPv4:* When set to IPv4, the system will use IPv4 on the network interface.

*IPv6:* When set to IPv6, the system will use IPv6 on the network interface.

**Example:** Network 1 IPStack: Dual

### Network [1..1] IPv4 Assignment

Define how the system will obtain its IPv4 address, subnet mask and gateway address. This setting only applies to systems on IPv4 networks.

**Requires user role:** ADMIN

**Value space:** <Static/DHCP>

*Static:* The addresses must be configured manually using the Network IPv4 Address, Network IPv4 Gateway and Network IPv4 SubnetMask settings (static addresses).

*DHCP:* The system addresses are automatically assigned by the DHCP server.

**Example:** Network 1 IPv4 Assignment: DHCP

### Network [1..1] IPv4 Address

Enter the static IPv4 network address for the system. This setting is only applicable when Network Assignment is set to Static.

**Requires user role:** ADMIN

**Value space:** <S: 0, 64>

*Format:* A valid IPv4 address.

**Example:** Network 1 IPv4 Address: "192.0.2.2"

### Network [1..1] IPv4 Gateway

Define the IPv4 network gateway. This setting is only applicable when the Network Assignment is set to Static.

**Requires user role:** ADMIN

**Value space:** <S: 0, 64>

*Format:* A valid IPv4 address.

**Example:** Network 1 IPv4 Gateway: "192.0.2.1"

### Network [1..1] IPv4 SubnetMask

Define the IPv4 network subnet mask. This setting is only applicable when the Network Assignment is set to Static.

**Requires user role:** ADMIN

**Value space:** <S: 0, 64>

*Format:* The valid IPv4 address format.

**Example:** Network 1 IPv4 SubnetMask: "255.255.255.0"

### Network [1..1] IPv6 Assignment

Define how the system will obtain its IPv6 address and the default gateway address. This setting only applies to systems on IPv6 networks.

**Requires user role:** ADMIN

**Value space:** <Static/DHCPv6/Autoconf>

*Static:* The codec and gateway IP addresses must be configured manually using the Network IPv6 Address and Network IPv6 Gateway settings. The options, for example NTP and DNS server addresses, must either be set manually or obtained from a DHCPv6 server. The Network IPv6 DHCPv6Options setting determines which method to use.

*DHCPv6:* All IPv6 addresses, including options, will be obtained from a DHCPv6 server. See RFC 3315 for a detailed description. The Network IPv6 DHCPv6Options setting will be ignored.

*Autoconf:* Enable IPv6 stateless autoconfiguration of the IPv6 network interface. See RFC 4862 for a detailed description. The options, for example NTP and DNS server addresses, must either be set manually or obtained from a DHCPv6 server. The Network IPv6 DHCPv6Options setting determines which method to use.

**Example:** Network 1 IPv6 Assignment: Autoconf



### Network [1..1] IPv6 Address

Enter the static IPv6 network address for the system. This setting is only applicable when the Network IPv6 Assignment is set to Static.

**Requires user role:** ADMIN

**Value space:** <S: 0, 64>

*Format:* A valid IPv6 address.

**Example:** Network 1 IPv6 Address: "2001:0DB8:0000:0000:0000:0000:0002"

### Network [1..1] IPv6 Gateway

Define the IPv6 network gateway address. This setting is only applicable when the Network IPv6 Assignment is set to Static.

**Requires user role:** ADMIN

**Value space:** <S: 0, 64>

*Format:* A valid IPv6 address.

**Example:** Network 1 IPv6 Gateway: "2001:0DB8:0000:0000:0000:0000:0001"

### Network [1..1] IPv6 DHCPOptions

Retrieve a set of DHCP options, for example NTP and DNS server addresses, from a DHCPv6 server.

**Requires user role:** ADMIN

**Value space:** <Off/On>

*Off:* Disable the retrieval of DHCP options from a DHCPv6 server.

*On:* Enable the retrieval of a selected set of DHCP options from a DHCPv6 server.

**Example:** Network 1 IPv6 DHCPOptions: On

### Network [1..1] DHCP RequestTFTPServerAddress

This setting is used only for video systems that are registered to a Cisco Unified Communications Manager (CUCM).

The setting determines whether the endpoint should ask the DHCP server for DHCP option 150, so that it can discover the address of the TFTP server (provisioning server) automatically.

If this setting is Off or the DHCP server does not support option 150, the TFTP server address must be set manually using the Provisioning ExternalManager Address setting.

Note: If the Network VLAN Voice Mode setting is Auto and the Cisco Discovery Protocol (CDP) assigns an ID to the voice VLAN, then a request for option 150 will always be sent. That is, the Network DHCP RequestTFTPServerAddress setting will be ignored.

**Requires user role:** ADMIN

**Value space:** <Off/On>

*Off:* The video system will not send a request for DHCP option 150 and the address of the TFTP server must be set manually. See the note above for any exception to this rule.

*On:* The video system will send a request for option 150 to the DHCP server so that it can automatically discover the address of the TFTP server.

**Example:** Network 1 DHCP RequestTFTPServerAddress: On

### Network [1..1] DNS Domain Name

DNS Domain Name is the default domain name suffix which is added to unqualified names.

Example: If the DNS Domain Name is "company.com" and the name to lookup is "MyVideoSystem", this will result in the DNS lookup "MyVideoSystem.company.com".

**Requires user role:** ADMIN

**Value space:** <S: 0, 64>

*Format:* String with a maximum of 64 characters.

**Example:** Network 1 DNS Domain Name: ""

### Network [1..1] DNS Server [1..3] Address

Define the network addresses for DNS servers. Up to 3 addresses may be specified. If the network addresses are unknown, contact your administrator or Internet Service Provider.

**Requires user role:** ADMIN

**Value space:** <S: 0, 64>

*Format:* A valid IPv4 address or IPv6 address.

**Example:** Network 1 DNS Server 1 Address: ""

## Network [1..1] QoS Mode

The QoS (Quality of Service) is a method which handles the priority of audio, video and data in the network. The QoS settings must be supported by the infrastructure. Diffserv (Differentiated Services) is a computer networking architecture that specifies a simple, scalable and coarse-grained mechanism for classifying, managing network traffic and providing QoS priorities on modern IP networks.

**Requires user role:** ADMIN

**Value space:** <Off/Diffserv>

*Off:* No QoS method is used.

*Diffserv:* When you set the QoS Mode to Diffserv, the Network QoS Diffserv Audio, Network QoS Diffserv Video, Network QoS Diffserv Data, Network QoS Diffserv Signalling, Network QoS Diffserv ICMPv6 and Network QoS Diffserv NTP settings are used to prioritize packets.

**Example:** Network 1 QoS Mode: Diffserv

## Network [1..1] QoS Diffserv Audio

Note: This setting will only take effect if Network QoS Mode is set to Diffserv.

Define which priority Audio packets should have in the IP network.

The priority for the packets ranges from 0 to 63 - the higher the number, the higher the priority. The recommended class for Audio is CS4, which equals the decimal value 32. If in doubt, contact your network administrator.

The priority set here might be overridden when packets are leaving the network controlled by the local network administrator.

**Requires user role:** ADMIN

**Value space:** <0..63>

*Range:* Select a value between 0 to 63 - the higher the number, the higher the priority. The default value is 0 (best effort).

**Example:** Network 1 QoS Diffserv Audio: 0

## Network [1..1] QoS Diffserv Video

Note: This setting will only take effect if Network QoS Mode is set to Diffserv.

Define which priority Video packets should have in the IP network. The packets on the presentation channel (shared content) are also in the Video packet category.

The priority for the packets ranges from 0 to 63 - the higher the number, the higher the priority. The recommended class for Video is CS4, which equals the decimal value 32. If in doubt, contact your network administrator.

The priority set here might be overridden when packets are leaving the network controlled by the local network administrator.

**Requires user role:** ADMIN

**Value space:** <0..63>

*Range:* Select a value between 0 to 63 - the higher the number, the higher the priority. The default value is 0 (best effort).

**Example:** Network 1 QoS Diffserv Video: 0

## Network [1..1] QoS Diffserv Data

Note: This setting will only take effect if Network QoS Mode is set to Diffserv.

Define which priority Data packets should have in the IP network.

The priority for the packets ranges from 0 to 63 - the higher the number, the higher the priority. The recommended value for Data is 0, which means best effort. If in doubt, contact your network administrator.

The priority set here might be overridden when packets are leaving the network controlled by the local network administrator.

**Requires user role:** ADMIN

**Value space:** <0..63>

*Range:* Select a value between 0 to 63 - the higher the number, the higher the priority. The default value is 0 (best effort).

**Example:** Network 1 QoS Diffserv Data: 0

### Network [1..1] QoS Diffserv Signalling

Note: This setting will only take effect if Network QoS Mode is set to Diffserv.

Define which priority Signalling packets that are deemed critical (time-sensitive) for the real-time operation should have in the IP network.

The priority for the packets ranges from 0 to 63 - the higher the number, the higher the priority. The recommended class for Signalling is CS3, which equals the decimal value 24. If in doubt, contact your network administrator.

The priority set here might be overridden when packets are leaving the network controlled by the local network administrator.

**Requires user role:** ADMIN

**Value space:** <0..63>

*Range:* Select a value between 0 to 63 - the higher the number, the higher the priority. The default value is 0 (best effort).

**Example:** Network 1 QoS Diffserv Signalling: 0

### Network [1..1] QoS Diffserv ICMPv6

Note: This setting will only take effect if Network QoS Mode is set to Diffserv.

Define which priority ICMPv6 packets should have in the IP network.

The priority for the packets ranges from 0 to 63 - the higher the number, the higher the priority. The recommended value for ICMPv6 is 0, which means best effort. If in doubt, contact your network administrator.

The priority set here might be overridden when packets are leaving the network controlled by the local network administrator.

**Requires user role:** ADMIN

**Value space:** <0..63>

*Range:* Select a value between 0 to 63 - the higher the number, the higher the priority. The default value is 0 (best effort).

**Example:** Network 1 QoS Diffserv ICMPv6: 0

### Network [1..1] QoS Diffserv NTP

Note: This setting will only take effect if Network QoS Mode is set to Diffserv.

Define which priority NTP packets should have in the IP network.

The priority for the packets ranges from 0 to 63 - the higher the number, the higher the priority. The recommended value for NTP is 0, which means best effort. If in doubt, contact your network administrator.

The priority set here might be overridden when packets are leaving the network controlled by the local network administrator.

**Requires user role:** ADMIN

**Value space:** <0..63>

*Range:* Select a value between 0 to 63 - the higher the number, the higher the priority. The default value is 0 (best effort).

**Example:** Network 1 QoS Diffserv NTP: 0

### Network [1..1] IEEE8021X Mode

The system can be connected to an IEEE 802.1X LAN network, with a port-based network access control that is used to provide authenticated network access for Ethernet networks.

**Requires user role:** ADMIN

**Value space:** <Off/On>

*Off:* The 802.1X authentication is disabled (default).

*On:* The 802.1X authentication is enabled.

**Example:** Network 1 IEEE8021X Mode: Off

### Network [1..1] IEEE8021X TlsVerify

Verification of the server-side certificate of an IEEE802.1x connection against the certificates in the local CA-list when TLS is used. The CA-list must be uploaded to the video system. This can be done from the web interface.

This setting takes effect only when Network [1..1] IEEE8021X Eap Tls is enabled (On).

**Requires user role:** ADMIN

**Value space:** <Off/On>

*Off:* When set to Off, TLS connections are allowed without verifying the server-side X.509 certificate against the local CA-list. This should typically be selected if no CA-list has been uploaded to the codec.

*On:* When set to On, the server-side X.509 certificate will be validated against the local CA-list for all TLS connections. Only servers with a valid certificate will be allowed.

**Example:** Network 1 IEEE8021X TlsVerify: Off

### Network [1..1] IEEE8021X UseClientCertificate

Authentication using a private key/certificate pair during an IEEE802.1x connection. The authentication X.509 certificate must be uploaded to the video system. This can be done from the web interface.

**Requires user role:** ADMIN

**Value space:** <Off/On>

*Off:* When set to Off client-side authentication is not used (only server-side).

*On:* When set to On the client (video system) will perform a mutual authentication TLS handshake with the server.

**Example:** Network 1 IEEE8021X UseClientCertificate: Off

### Network [1..1] IEEE8021X Identity

The 802.1X Identity is the user name needed for 802.1X authentication.

**Requires user role:** ADMIN

**Value space:** <S: 0, 64>

*Format:* String with a maximum of 64 characters.

**Example:** Network 1 IEEE8021X Identity: ""

### Network [1..1] IEEE8021X Password

The 802.1X Password is the password needed for 802.1X authentication.

**Requires user role:** ADMIN

**Value space:** <S: 0, 32>

*Format:* String with a maximum of 32 characters.

**Example:** Network 1 IEEE8021X Password: ""

### Network [1..1] IEEE8021X AnonymousIdentity

The 802.1X Anonymous ID string is to be used as unencrypted identity with EAP (Extensible Authentication Protocol) types that support different tunneled identity, like EAP-PEAP and EAP-TTLS. If set, the anonymous ID will be used for the initial (unencrypted) EAP Identity Request.

**Requires user role:** ADMIN

**Value space:** <S: 0, 64>

*Format:* String with a maximum of 64 characters.

**Example:** Network 1 IEEE8021X AnonymousIdentity: ""

### Network [1..1] IEEE8021X Eap Md5

Set the Md5 (Message-Digest Algorithm 5) mode. This is a Challenge Handshake Authentication Protocol that relies on a shared secret. Md5 is a Weak security.

**Requires user role:** ADMIN

**Value space:** <Off/On>

*Off:* The EAP-MD5 protocol is disabled.

*On:* The EAP-MD5 protocol is enabled (default).

**Example:** Network 1 IEEE8021X Eap Md5: On

### Network [1..1] IEEE8021X Eap Ttls

Set the TTLS (Tunneled Transport Layer Security) mode. Authenticates LAN clients without the need for client certificates. Developed by Funk Software and Certicom. Usually supported by Agere Systems, Proxim and Avaya.

**Requires user role:** ADMIN

**Value space:** <Off/On>

*Off:* The EAP-TTLS protocol is disabled.

*On:* The EAP-TTLS protocol is enabled (default).

**Example:** Network 1 IEEE8021X Eap Ttls: On

### Network [1..1] IEEE8021X Eap Tls

Enable or disable the use of EAP-TLS (Transport Layer Security) for IEEE802.1x connections. The EAP-TLS protocol, defined in RFC 5216, is considered one of the most secure EAP standards. LAN clients are authenticated using client certificates.

**Requires user role:** ADMIN

**Value space:** <Off/On>

*Off:* The EAP-TLS protocol is disabled.

*On:* The EAP-TLS protocol is enabled (default).

**Example:** Network 1 IEEE8021X Eap Tls: On

### Network [1..1] IEEE8021X Eap Peap

Set the Peap (Protected Extensible Authentication Protocol) mode. Authenticates LAN clients without the need for client certificates. Developed by Microsoft, Cisco and RSA Security.

**Requires user role:** ADMIN

**Value space:** <Off/On>

*Off:* The EAP-PEAP protocol is disabled.

*On:* The EAP-PEAP protocol is enabled (default).

**Example:** Network 1 IEEE8021X Eap Peap: On

### Network [1..1] MTU

Set the Ethernet MTU (Maximum Transmission Unit).

**Requires user role:** ADMIN

**Value space:** <576..1500>

*Range:* Select a value from 576 to 1500 bytes.

**Example:** Network 1 MTU: 1500

### Network [1..1] Speed

Set the Ethernet link speed.

NOTE: If running older software versions than TC6.0, restart the system for any change to this setting to take effect.

**Requires user role:** ADMIN

**Value space:** <Auto/10half/10full/100half/100full/1000full>

*Auto:* Autonegotiate link speed.

*10half:* Force link to 10 Mbps half-duplex.

*10full:* Force link to 10 Mbps full-duplex.

*100half:* Force link to 100 Mbps half-duplex.

*100full:* Force link to 100 Mbps full-duplex.

*1000full:* Force link to 1 Gbps full-duplex.

**Example:** Network 1 Speed: Auto

### Network [1..1] TrafficControl Mode

Set the network traffic control mode to decide how to control the video packets transmission speed.

**Requires user role:** ADMIN

**Value space:** <Off/On>

*Off:* Transmit video packets at link speed.

*On:* Transmit video packets at maximum 20 Mbps. Can be used to smooth out bursts in the outgoing network traffic.

**Example:** Network 1 TrafficControl: On

### Network [1..1] RemoteAccess Allow

Filter IP addresses for access to ssh/telnet/HTTP/HTTPS.

**Requires user role:** ADMIN

**Value space:** <S: 0, 255>

*Format:* String with a maximum of 255 characters, comma separated IP addresses or IP range.

**Example:** Network 1 RemoteAccess Allow: "192.168.1.231, 192.168.1.182"

### Network [1..1] VLAN Voice Mode

Set the VLAN voice mode. The VLAN Voice Mode will be set to Auto automatically if you choose Cisco UCM (Cisco Unified Communications Manager) as provisioning infrastructure via the Provisioning Wizard on the Touch controller.

**Requires user role:** ADMIN

**Value space:** <Auto/Manual/Off>

*Auto:* The Cisco Discovery Protocol (CDP), if available, assigns an id to the voice VLAN. If CDP is not available, VLAN is not enabled.

*Manual:* The VLAN ID is set manually using the Network VLAN Voice VlanId setting. If CDP is available, the manually set value will be overruled by the value assigned by CDP.

*Off:* VLAN is not enabled.

**Example:** Network 1 VLAN Voice Mode: Off

### Network [1..1] VLAN Voice VlanId

Set the VLAN voice ID. This setting will only take effect if VLAN Voice Mode is set to Manual.

**Requires user role:** ADMIN

**Value space:** <1..4094>

*Range:* Select a value from 1 to 4094.

**Example:** Network 1 VLAN Voice VlanId: 1

## NetworkPort settings

### NetworkPort [2] Mode

Define if the network port 2 shall be enabled for direct pairing with a Cisco TelePresence Touch controller.

NOTE: Restart the system for any change to this setting to take effect.

**Requires user role:** ADMIN

**Value space:** <Inactive/DirectPairing>

*Inactive:* Set the NetworkPort 2 to Inactive when no device is connected.

*DirectPairing:* Set the NetworkPort 2 to DirectPairing when you have a Cisco TelePresence Touch controller connected to the port. This will enable for direct pairing between the Touch controller and the codec.

**Example:** NetworkPort 2 Mode: Inactive

## NetworkServices settings

### NetworkServices H323 Mode

Determine whether the system should be able to place and receive H.323 calls or not.

**Requires user role:** ADMIN

**Value space:** <Off/On>

*Off:* Disable the possibility to place and receive H.323 calls.

*On:* Enable the possibility to place and receive H.323 calls (default).

**Example:** NetworkServices H323 Mode: On

### NetworkServices HTTP Mode

Set the HTTP mode to enable/disable access to the system through a web browser. The web interface is used for system management, call management such as call transfer, diagnostics and software uploads.

NOTE: Restart the system for any change to this setting to take effect.

**Requires user role:** ADMIN

**Value space:** <Off/On>

*Off:* The HTTP protocol is disabled.

*On:* The HTTP protocol is enabled.

**Example:** NetworkServices HTTP Mode: On

### NetworkServices SIP Mode

Determine whether the system should be able to place and receive SIP calls or not.

**Requires user role:** ADMIN

**Value space:** <Off/On>

*Off:* Disable the possibility to place and receive SIP calls.

*On:* Enable the possibility to place and receive SIP calls (default).

**Example:** NetworkServices SIP Mode: On

### NetworkServices Telnet Mode

Telnet is a network protocol used on the Internet or Local Area Network (LAN) connections.

**Requires user role:** ADMIN

**Value space:** <Off/On>

*Off:* The Telnet protocol is disabled. This is the factory setting.

*On:* The Telnet protocol is enabled.

**Example:** NetworkServices Telnet Mode: Off

### NetworkServices WelcomeText

Choose which information the user should see when logging on to the codec through Telnet/SSH.

**Requires user role:** ADMIN

**Value space:** <Off/On>

*Off:* The welcome text is: Login successful

*On:* The welcome text is: Welcome to <system name>; Software version; Software release date; Login successful.

**Example:** NetworkServices WelcomeText: On

### NetworkServices XMLAPI Mode

Enable or disable the video system's XML API. For security reasons this may be disabled. Disabling the XML API will limit the remote manageability with for example TMS, which no longer will be able to connect to the video system.

**Requires user role:** ADMIN

**Value space:** <Off/On>

*Off:* The XML API is disabled.

*On:* The XML API is enabled (default).

**Example:** NetworkServices XMLAPI Mode: On



### NetworkServices MultiWay Address

The MultiWay address must be equal to the Conference Factory Alias, as configured on the Video Communication Server. The Multiway™ conferencing enables video endpoint users to introduce a 3rd party into an existing call.

Multiway™ can be used in the following situations:

- 1) When you want to add someone else in to your existing call.
- 2) When you are called by a 3rd party while already in a call and you want to include that person in the call.

Requirements: The Codec C60/C40 must run software version TC4.0 (or later), Video Communication Server (VCS) version X5 (or later) and Codian MCU version 3.1 (or later). Video systems invited to join the Multiway™ conference must support the H.323 routeToMC facility message if in an H.323 call, or SIP REFER message if in a SIP call.

**Requires user role:** ADMIN

**Value space:** <S: 0, 255>

*Format:* String with a maximum of 255 characters (a valid dial URI).

**Example:** NetworkServices MultiWay Address: "h323:multiway@company.com"

### NetworkServices MultiWay Protocol

Determine the protocol to be used for MultiWay calls.

**Requires user role:** ADMIN

**Value space:** <Auto/H323/Sip>

*Auto:* The system will select the protocol for MultiWay calls.

*H323:* The H323 protocol will be used for MultiWay calls.

*Sip:* The SIP protocol will be used for MultiWay calls.

**Example:** NetworkServices MultiWay Protocol: Auto

### NetworkServices HTTPS Mode

HTTPS is a web protocol that encrypts and decrypts user page requests as well as the pages that are returned by the web server.

NOTE: Restart the system for any change to this setting to take effect.

**Requires user role:** ADMIN

**Value space:** <Off/On>

*Off:* The HTTPS protocol is disabled.

*On:* The HTTPS protocol is enabled.

**Example:** NetworkServices HTTPS Mode: On

### NetworkServices HTTPS VerifyServerCertificate

When the video system connects to an external HTTPS server (like a phone book server or an external manager), this server will present a certificate to the video system to identify itself.

**Requires user role:** ADMIN

**Value space:** <Off/On>

*Off:* Do not verify server certificates.

*On:* Requires the system to verify that the server certificate is signed by a trusted Certificate Authority (CA). This requires that a list of trusted CAs are uploaded to the system in advance.

**Example:** NetworkServices HTTPS VerifyServerCertificate: Off

### NetworkServices HTTPS VerifyClientCertificate

When the video system connects to a HTTPS client (like a web browser), the client can be asked to present a certificate to the video system to identify itself.

**Requires user role:** ADMIN

**Value space:** <Off/On>

*Off:* Do not verify client certificates.

*On:* Requires the client to present a certificate that is signed by a trusted Certificate Authority (CA). This requires that a list of trusted CAs are uploaded to the system in advance.

**Example:** NetworkServices HTTPS VerifyClientCertificate: Off

### NetworkServices HTTPS OCSP Mode

Define the support for OCSP (Online Certificate Status Protocol) responder services. The OCSP feature allows users to enable OCSP instead of certificate revocation lists (CRLs) to check the certificate status.

For any outgoing HTTPS connection, the OCSP responder is queried of the status. If the corresponding certificate has been revoked, then the HTTPS connection will not be used.

**Requires user role:** ADMIN

**Value space:** <Off/On>

*Off:* Disable OCSP support.

*On:* Enable OCSP support.

**Example:** NetworkServices HTTPS OCSP Mode: Off

### NetworkServices HTTPS OCSP URL

Specify the URL of the OCSP responder (server) that will be used to check the certificate status.

**Requires user role:** ADMIN

**Value space:** <S: 0, 255>

*Format:* String with a maximum of 255 characters.

**Example:** NetworkServices HTTPS OCSP URL: "http://ocspserver.company.com:81"

### NetworkServices NTP Mode

The Network Time Protocol (NTP) is used to synchronize the time of the system to a reference time server. The time server will subsequently be queried every 24th hour for time updates. The time will be displayed on the top of the screen. The system will use the time to timestamp messages transmitted to Gatekeepers or Border Controllers requiring H.235 authentication. The system will use the time to timestamp messages transmitted to Gatekeepers or Border Controllers that requires H.235 authentication. It is also used for timestamping Placed Calls, Missed Calls and Received Calls.

**Requires user role:** ADMIN

**Value space:** <Auto/Off/Manual>

*Auto:* The system will use the NTP server, by which address is supplied from the DHCP server in the network. If no DHCP server is used, or the DHCP server does not provide the system with a NTP server address, the system will use the static defined NTP server address specified by the user.

*Off:* The system will not use an NTP server.

*Manual:* The system will always use the static defined NTP server address specified by the user.

**Example:** NetworkServices NTP Mode: Manual

### NetworkServices NTP Address

Enter the NTP Address to define the network time protocol server address. This address will be used if NTP Mode is set to Manual, or if set to Auto and no address is supplied by a DHCP server.

**Requires user role:** ADMIN

**Value space:** <S: 0, 64>

*Format:* A valid IPv4 address, IPv6 address or DNS name.

**Example:** NetworkServices NTP Address: "1.ntp.tandberg.com"

### NetworkServices SNMP Mode

SNMP (Simple Network Management Protocol) is used in network management systems to monitor network-attached devices (routers, servers, switches, projectors, etc) for conditions that warrant administrative attention. SNMP exposes management data in the form of variables on the managed systems, which describe the system configuration. These variables can then be queried (set to ReadOnly) and sometimes set (set to ReadWrite) by managing applications.

**Requires user role:** ADMIN

**Value space:** <Off/ReadOnly/ReadWrite>

*Off:* Disable the SNMP network service.

*ReadOnly:* Enable the SNMP network service for queries only.

*ReadWrite:* Enable the SNMP network service for both queries and commands.

**Example:** NetworkServices SNMP Mode: ReadWrite

### NetworkServices SNMP Host [1..3] Address

Enter the address of up to three SNMP Managers.

The system's SNMP Agent (in the codec) responds to requests from SNMP Managers (a PC program etc.), for example about system location and system contact. SNMP traps are not supported.

**Requires user role:** ADMIN

**Value space:** <S: 0, 64>

*Format:* A valid IPv4 address, IPv6 address or DNS name.

**Example:** NetworkServices SNMP Host 1 Address: ""

### NetworkServices SNMP CommunityName

Enter the name of the Network Services SNMP Community. SNMP Community names are used to authenticate SNMP requests. SNMP requests must have a password (case sensitive) in order to receive a response from the SNMP Agent in the codec. The default password is "public". If you have the Cisco TelePresence Management Suite (TMS) you must make sure the same SNMP Community is configured there too. NOTE: The SNMP Community password is case sensitive.

**Requires user role:** ADMIN

**Value space:** <S: 0, 50>

*Format:* String with a maximum of 50 characters.

**Example:** NetworkServices SNMP CommunityName: "public"

### NetworkServices SNMP SystemContact

Enter the name of the Network Services SNMP System Contact.

**Requires user role:** ADMIN

**Value space:** <S: 0, 50>

*Format:* String with a maximum of 50 characters.

**Example:** NetworkServices SNMP SystemContact: ""

### NetworkServices SNMP SystemLocation

Enter the name of the Network Services SNMP System Location.

**Requires user role:** ADMIN

**Value space:** <S: 0, 50>

*Format:* String with a maximum of 50 characters.

**Example:** NetworkServices SNMP SystemLocation: ""

### NetworkServices SSH Mode

SSH (or Secure Shell) protocol can provide secure encrypted communication between the codec and your local computer.

**Requires user role:** ADMIN

**Value space:** <Off/On>

*Off:* The SSH protocol is disabled.

*On:* The SSH protocol is enabled.

**Example:** NetworkServices SSH Mode: On

### NetworkServices SSH AllowPublicKey

Secure Shell (SSH) public key authentication can be used to access the codec.

**Requires user role:** ADMIN

**Value space:** <Off/On>

*Off:* The SSH public key is not allowed.

*On:* The SSH public key is allowed.

**Example:** NetworkServices SSH AllowPublicKey: On

## NetworkServices CTMS Mode

This setting determines whether or not to allow multiparty conferences controlled by a Cisco TelePresence Multipoint Switch (CTMS).

Video systems running software TC5.0 or later are able to initiate or join non-encrypted multiparty conferences controlled by CTMS version 1.8 or later. Encrypted conferences are supported as from software versions TC6.0 and CTMS 1.9.1. Encryption is addressed in the NetworkServices CTMS Encryption setting.

**Requires user role:** ADMIN

**Value space:** <Off/On>

*Off:* Multiparty conferencing via CTMS is prohibited.

*On:* Multiparty conferencing via CTMS is allowed.

**Example:** NetworkServices CTMS Mode: On

## NetworkServices CTMS Encryption

This setting indicates whether or not the video system supports encryption when participating in a multiparty meeting controlled by a Cisco TelePresence Multipoint Switch (CTMS).

CTMS allows three security settings for meetings: non-secure (not encrypted), best effort (encrypted if all participants support encryption, otherwise not encrypted) and secure (always encrypted).

**Requires user role:** ADMIN

**Value space:** <Off/BestEffort>

*Off:* The video system does not allow encryption and therefore cannot participate in a secure CTMS meeting (encrypted). When participating in a best effort CTMS meeting, the meeting will be downgraded to non-secure (not encrypted).

*BestEffort:* The video system can negotiate encryption parameters with CTMS and participate in a secure CTMS meeting (encrypted). Do not use this value if the CTMS version is older than 1.9.1.

**Example:** NetworkServices CTMS Encryption: Off

## Phonebook settings

### Phonebook Server [1..1] ID

Enter a name for the external phone book.

**Requires user role:** ADMIN

**Value space:** <S: 0, 64>

*Format:* String with a maximum of 64 characters.

**Example:** Phonebook Server 1 ID: ""

### Phonebook Server [1..1] Type

Select the phonebook server type.

**Requires user role:** ADMIN

**Value space:** <VCS/TMS/Callway/CUCM>

*VCS:* Select VCS if the phonebook is located on the Cisco TelePresence Video Communication Server.

*TMS:* Select TMS if the phonebook is located on the Cisco TelePresence Management Suite server.

*Callway:* Select Callway if the phonebook is to be provided by the WebEx TelePresence subscription service (formerly called CallWay). Contact your WebEx TelePresence provider for more information.

*CUCM:* Select CUCM if the phonebook is located on the Cisco Unified Communications Manager.

**Example:** Phonebook Server 1 Type: TMS

### Phonebook Server [1..1] URL

Enter the address (URL) to the external phone book server.

**Requires user role:** ADMIN

**Value space:** <S: 0, 255>

*Format:* String with a maximum of 255 characters.

**Example:** Phonebook Server 1 URL: "http://tms.company.com/tms/public/external/phonebook/phonebookservice.asmx"

## Provisioning settings

### Provisioning Connectivity

This setting controls how the device discovers whether it should request an internal or external configuration from the provisioning server.

**Requires user role:** ADMIN

**Value space:** <Internal/External/Auto>

*Internal:* Request internal configuration.

*External:* Request external configuration.

*Auto:* Automatically discover using NAPTR queries whether internal or external configurations should be requested. If the NAPTR responses have the "e" flag, external configurations will be requested. Otherwise internal configurations will be requested.

**Example:** Provisioning Connectivity: Auto

### Provisioning Mode

It is possible to configure a video system using a provisioning system (external manager). This allows video conferencing network administrators to manage many video systems simultaneously.

With this setting you choose which type of provisioning system to use. Provisioning can also be switched off. Contact your provisioning system provider/representative for more information.

**Requires user role:** ADMIN

**Value space:** <Off/TMS/VCS/CallWay/CUCM/Auto>

*Off:* The video system will not be configured by a provisioning system.

*TMS:* The video system will be configured using TMS (Cisco TelePresence Management System).

*VCS:* Not applicable in this version.

*Callway:* The video system will be configured using the WebEx TelePresence subscription service (formerly called Callway).

*CUCM:* The video system will be configured using CUCM (Cisco Unified Communications Manager).

*Auto:* The provisioning server will automatically be selected by the video system.

**Example:** Provisioning Mode: TMS

### Provisioning LoginName

This is the user name part of the credentials used to authenticate the video system with the provisioning server. This setting must be used when required by the provisioning server. If Provisioning Mode is Callway (WebEx TelePresence), enter the video number.

**Requires user role:** ADMIN

**Value space:** <S: 0, 80>

*Format:* String with a maximum of 80 characters.

**Example:** Provisioning LoginName: ""

### Provisioning Password

This is the password part of the credentials used to authenticate the video system with the provisioning server. This setting must be used when required by the provisioning server. If Provisioning Mode is Callway (WebEx TelePresence), enter the activation code.

**Requires user role:** ADMIN

**Value space:** <S: 0, 64>

*Format:* String with a maximum of 64 characters.

**Example:** Provisioning Password: ""

### Provisioning HttpMethod

Select the HTTP method to be used for the provisioning.

**Requires user role:** ADMIN

**Value space:** <GET/POST>

*GET:* Select GET when the provisioning server supports GET.

*POST:* Select POST when the provisioning server supports POST.

**Example:** Provisioning HttpMethod: POST

### Provisioning ExternalManager Address

Enter the IP Address or DNS name of the external manager / provisioning system.

If an External Manager Address (and Path) is configured, the system will send a message to this address when starting up. When receiving this message the external manager / provisioning system can return configurations/commands to the unit as a result.

When using CUCM or TMS provisioning, the DHCP server can be set up to provide the external manager address automatically (DHCP Option 242 for TMS, and DHCP Option 150 for CUCM). An address set in the Provisioning ExternalManager Address setting will override the address provided by DHCP.

**Requires user role:** ADMIN

**Value space:** <S: 0, 64>

*Format:* A valid IPv4 address, IPv6 address or DNS name.

**Example:** Provisioning ExternalManager Address: ""

### Provisioning ExternalManager AlternateAddress

Only applicable when the endpoint is provisioned by Cisco Unified Communication Manager (CUCM) and an alternate CUCM is available for redundancy. Enter the address of the alternate CUCM. If the main CUCM is not available, the endpoint will be provisioned by the alternate CUCM. When the main CUCM is available again, the endpoint will be provisioned by this CUCM.

**Requires user role:** ADMIN

**Value space:** <S: 0, 64>

*Format:* A valid IPv4 address, IPv6 address or DNS name.

**Example:** Provisioning ExternalManager AlternateAddress: ""

### Provisioning ExternalManager Protocol

Determine whether to use secure management or not.

**Requires user role:** ADMIN

**Value space:** <HTTP/HTTPS>

*HTTP:* Set to HTTP to disable secure management. Requires HTTP to be enabled in the NetworkServices HTTP Mode setting.

*HTTPS:* Set to HTTPS to enable secure management. Requires HTTPS to be enabled in the NetworkServices HTTPS Mode setting.

**Example:** Provisioning ExternalManager Protocol: HTTP

### Provisioning ExternalManager Path

Set the Path to the external manager / provisioning system. This setting is required when several management services reside on the same server, i.e. share the same External Manager address.

**Requires user role:** ADMIN

**Value space:** <S: 0, 255>

*Format:* String with a maximum of 255 characters.

**Example:** Provisioning ExternalManager Path: "tms/public/external/management/SystemManagementService.asmx"

### Provisioning ExternalManager Domain

Enter the SIP domain for the VCS provisioning server.

**Requires user role:** ADMIN

**Value space:** <S: 0, 64>

*Format:* String with a maximum of 64 characters.

**Example:** Provisioning ExternalManager Domain: "any.domain.com"

## RTP settings

### RTP Ports Range Start

Specify the first port in the range of RTP ports. Also see the H323 Profile [1..1] PortAllocation setting.

NOTE: Restart the system for any change to this setting to take effect.

**Requires user role:** ADMIN

**Value space:** <1024..65502>

*Range:* Select a value from 1024 to 65502.

**Example:** RTP Ports Range Start: 2326

### RTP Ports Range Stop

Specify the last RTP port in the range. Also see the H323 Profile [1..1] PortAllocation setting.

NOTE: Restart the system for any change to this setting to take effect.

**Requires user role:** ADMIN

**Value space:** <1056..65535>

*Range:* Select a value from 1056 to 65535.

**Example:** RTP Ports Range Stop: 2486



## Security settings

### Security Audit Logging Mode

Determine where to record or transmit the audit logs. The audit logs are sent to a syslog server. When using the External/ExternalSecure modes and setting the port assignment to manual in the Security Audit Server PortAssignment setting, you must also enter the address and port number for the audit server in the Security Audit Server Address and Security Audit Server Port settings.

**Requires user role:** AUDIT

**Value space:** <Off/Internal/External/ExternalSecure>

*Off:* No audit logging is performed.

*Internal:* The system records the audit logs to internal logs, and rotates logs when they are full.

*External:* The system sends the audit logs to an external syslog server. The syslog server must support UDP.

*ExternalSecure:* The system sends encrypted audit logs to an external syslog server that is verified by a certificate in the Audit CA list. The Audit CA list file must be uploaded to the codec using the web interface. The common\_name parameter of a certificate in the CA list must match the IP address of the syslog server, and the secure TCP server must be set up to listen for secure (TLS) TCP Syslog messages.

**Example:** Security Audit Logging Mode: Off

### Security Audit OnError Action

Determine what happens when the connection to the syslog server is lost. This setting is only relevant when Security Audit Logging Mode is set to ExternalSecure.

**Requires user role:** AUDIT

**Value space:** <Halt/Ignore>

*Halt:* If a halt condition is detected the system codec is rebooted and only the auditor is allowed to operate the unit until the halt condition has passed. When the halt condition has passed the audit logs are re-spooled to the syslog server. Halt conditions are: A network breach (no physical link), no syslog server running (or incorrect address or port to the syslog server), TLS authentication failed (if in use), local backup (re-spooling) log full.

*Ignore:* The system will continue its normal operation, and rotate internal logs when full. When the connection is restored it will again send its audit logs to the syslog server.

**Example:** Security Audit OnError Action: Ignore

### Security Audit Server Address

The audit logs are sent to a syslog server. Enter the IP address of the syslog server. Only valid IPv4 or IPv6 address formats are accepted. Host names are not supported. This setting is only relevant when Security Audit Logging Mode is set to External or ExternalSecure.

**Requires user role:** AUDIT

**Value space:** <S: 0, 64>

*Format:* A valid IPv4 address or IPv6 address

**Example:** Security Audit Server Address: ""

### Security Audit Server Port

The audit logs are sent to a syslog server. Enter the port of the syslog server that the system shall send its audit logs to. This setting is only relevant when Security Audit PortAssignment is set to Manual.

**Requires user role:** AUDIT

**Value space:** <0..65535>

*Range:* Select a value from 0 to 65535.

**Example:** Security Audit Server Port: 514

### Security Audit Server PortAssignment

The audit logs are sent to a syslog server. You can define how the port number of the external syslog server will be assigned. This setting is only relevant when Security Audit Logging Mode is set to External or ExternalSecure. To see which port number is used you can check the Security Audit Server Port status. Navigate to Configuration > System status on the web interface or; if on a command line interface, run the command xStatus Security Audit Server Port.

**Requires user role:** AUDIT

**Value space:** <Auto/Manual>

*Auto:* Will use UDP port number 514 when the Security Audit Logging Mode is set to External. Will use TCP port number 6514 when the Security Audit Logging Mode is set to ExternalSecure.

*Manual:* Will use the port value defined in the Security Audit Server Port setting.

**Example:** Security Audit Server PortAssignment: Auto

## Security Session ShowLastLogon

When logging in to the system using SSH or Telnet you will see the UserId, time and date of the last session that did a successful login.

**Requires user role:** ADMIN

**Value space:** <Off/On>

*On:* Show information about the last session.

*Off:* Do not show information about the last session.

**Example:** Security Session ShowLastLogon: Off

## Security Session InactivityTimeout

Determine how long the system will accept inactivity from the user before he is automatically logged out.

**Requires user role:** ADMIN

**Value space:** <0..10000>

*Range:* Select a value between 1 and 10000 seconds; or select 0 when inactivity should not enforce automatic logout.

**Example:** Security Session InactivityTimeout: 0

## SerialPort settings

### SerialPort Mode

Enable/disable the serial port (COM port).

**Requires user role:** ADMIN

**Value space:** <Off/On>

*Off:* Disable the serial port.

*On:* Enable the serial port.

**Example:** SerialPort Mode: On

### SerialPort BaudRate

Specify the baud rate (data transmission rate, bits per second) for the serial port. The default value is 38400.

Other connection parameters for the serial port are: Data bits: 8; Parity: None; Stop bits: 1; Flow control: None.

**Requires user role:** ADMIN

**Value space:** <9600/19200/38400/57600/115200>

*Range:* Select a baud rate from the baud rates listed (bps).

**Example:** SerialPort BaudRate: 38400

### SerialPort LoginRequired

Determine if login shall be required when connecting to the serial port.

**Requires user role:** ADMIN

**Value space:** <Off/On>

*Off:* The user can access the codec via the serial port without any login.

*On:* Login is required when connecting to the codec via the serial port.

**Example:** SerialPort LoginRequired: On

## SIP settings

### SIP ANAT

ANAT (Alternative Network Address Types) enables media negotiation for multiple addresses and address types, as specified in RFC 4091.

**Requires user role:** ADMIN

**Value space:** <Off/On>

*Off:* Disable ANAT.

*On:* Enable ANAT.

**Example:** SIP ANAT: Off

### SIP AuthenticateTransferror

Not applicable in this version.

### SIP ListenPort

Turn on or off the listening for incoming connections on the SIP TCP/UDP ports. If turned off, the endpoint will only be reachable through the SIP registrar (CUCM or VCS). It is recommended to leave this setting at its default value.

**Requires user role:** ADMIN

**Value space:** <On/Off>

*On:* Listening for incoming connections on the SIP TCP/UDP ports is turned on.

*Off:* Listening for incoming connections on the SIP TCP/UDP ports is turned off.

**Example:** SIP ListenPort: On

### SIP PreferredIPMedia

Define the preferred IP version for sending and receiving media (audio, video, data). Only applicable when both Network IPStack and Conference CallProtocolIPStack are set to Dual, and the network does not have a mechanism for choosing the preferred IP version.

**Requires user role:** ADMIN

**Value space:** <IPv4/IPv6>

*IPv4:* The preferred IP version for media is IPv4.

*IPv6:* The preferred IP version for media is IPv6.

**Example:** SIP PreferredIPMedia: IPv4

### SIP PreferredIPSignaling

Define the preferred IP version for signaling (audio, video, data). Only applicable when both Network IPStack and Conference CallProtocolIPStack are set to Dual, and the network does not have a mechanism for choosing the preferred IP version. It also determines the priority of the A/AAAA lookups in DNS, so that the preferred IP version is used for registration.

**Requires user role:** ADMIN

**Value space:** <IPv4/IPv6>

*IPv4:* The preferred IP version for signaling is IPv4.

*IPv6:* The preferred IP version for signaling is IPv6.

**Example:** SIP PreferredIPSignaling: IPv4

### SIP OCSP Mode

Not applicable in this version.

### SIP OCSP DefaultResponder

Not applicable in this version.

### SIP Profile [1..1] Ice Mode

ICE (Interactive Connectivity Establishment, RFC 5245) is a NAT traversal solution that the endpoints can use to discover the optimized media path. Thus the shortest route for audio and video is always secured between the endpoints. NOTE: ICE is not supported when registered to CUCM (Cisco Unified Communication Manager).

**Requires user role:** ADMIN

**Value space:** <Auto/Off/On>

*Auto:* When set to Auto, ICE will be enabled if a turn server is provided, otherwise ICE will be disabled.

*Off:* Set to Off to disable ICE.

*On:* Set to On to enable ICE.

**Example:** SIP Profile 1 Ice Mode: Auto

### SIP Profile [1..1] Ice DefaultCandidate

This is the default IP address that the endpoint will receive media on until ICE has reached a conclusion about which media route to use (up to the first 5 seconds of a call).

**Requires user role:** ADMIN

**Value space:** <Off/On>

*Host:* The endpoint will receive media on its own IP address.

*Rflx:* The endpoint will receive media on its public IP address as seen by the TURN server.

*Relay:* The endpoint will receive media on the IP address and port allocated on the TURN server, and is used as a fallback until ICE has concluded.

**Example:** SIP Profile 1 Ice DefaultCandidate: Host

### SIP Profile [1..1] Turn DiscoverMode

Set the discover mode to enable/disable the application to search for available Turn servers in DNS. Before making calls, the system will test if port allocation is possible.

**Requires user role:** ADMIN

**Value space:** <Off/On>

*Off:* Set to Off to disable discovery mode.

*On:* When set to On, the system will search for available Turn servers in DNS, and before making calls the system will test if port allocation is possible.

**Example:** SIP Profile Turn DiscoverMode: On

### SIP Profile [1..1] Turn BandwidthProbe

Not applicable in this version.

### SIP Profile [1..1] Turn DropRflx

DropRflx will make the endpoint force media through the Turn relay, unless the remote endpoint is on the same network.

**Requires user role:** ADMIN

**Value space:** <Off/On>

*Off:* Disable DropRflx.

*On:* The system will force media through the Turn relay when the remote endpoint is on another network.

**Example:** SIP Profile Turn DropRflx: Off

### SIP Profile [1..1] Turn Server

This is the address of the TURN (Traversal Using Relay NAT) server that the endpoints will use. It is used as a media relay fallback and it is also used to discover the endpoint's own public IP address.

**Requires user role:** ADMIN

**Value space:** <S: 0, 255>

*Format:* The preferred format is DNS SRV record (e.g. `_turn._udp.<domain>`), or it can be a valid IPv4 or IPv6 address.

**Example:** SIP Profile 1 Turn Server: `"_turn._udp.example.com"`

### SIP Profile [1..1] Turn UserName

The user name needed for accessing the TURN server.

**Requires user role:** ADMIN

**Value space:** <S: 0, 128>

*Format:* String with a maximum of 128 characters.

**Example:** SIP Profile 1 Turn UserName: `""`

### SIP Profile [1..1] Turn Password

The password needed for accessing the TURN server.

**Requires user role:** ADMIN

**Value space:** <S: 0, 128>

*Format:* String with a maximum of 128 characters.

**Example:** SIP Profile 1 Turn Password: ""

### SIP Profile [1..1] URI

The SIP URI (Uniform Resource Identifier) is the address that is used to identify the video system. The URI is registered and used by the SIP services to route inbound calls to the system. The SIP URI syntax is defined in RFC 3261.

**Requires user role:** ADMIN

**Value space:** <S: 0, 255>

*Format:* String with maximum 255 characters and compliant with the SIP URI syntax.

**Example:** SIP Profile 1 URI: "sip:firstname.lastname@company.com"

### SIP Profile [1..1] DisplayName

When configured the incoming call will report the DisplayName instead of the SIP URI.

**Requires user role:** ADMIN

**Value space:** <S: 0, 255>

*Format:* String with a maximum of 255 characters.

**Example:** SIP Profile 1 DisplayName: ""

### SIP Profile [1..1] Authentication [1..1] LoginName

This is the user name part of the credentials used to authenticate towards the SIP proxy.

**Requires user role:** ADMIN

**Value space:** <S: 0, 128>

*Format:* String with a maximum of 128 characters.

**Example:** SIP Profile 1 Authentication 1 LoginName: ""

### SIP Profile [1..1] Authentication [1..1] Password

This is the password part of the credentials used to authenticate towards the SIP proxy.

**Requires user role:** ADMIN

**Value space:** <S: 0, 128>

*Format:* String with a maximum of 128 characters.

**Example:** SIP Profile 1 Authentication 1 Password: ""

### SIP Profile [1..1] DefaultTransport

Select the transport protocol to be used over the LAN.

**Requires user role:** ADMIN

**Value space:** <TCP/UDP/Tls/Auto>

*TCP:* The system will always use TCP as the default transport method.

*UDP:* The system will always use UDP as the default transport method.

*Tls:* The system will always use TLS as the default transport method. For TLS connections a SIP CA-list can be uploaded to the video system. If no such CA-list is available on the system then anonymous Diffie Hellman will be used.

*Auto:* The system will try to connect using transport protocols in the following order: TLS, TCP, UDP.

**Example:** SIP Profile 1 DefaultTransport: Auto

### SIP Profile [1..1] TlsVerify

For TLS connections a SIP CA-list can be uploaded to the video system. This can be done from the web interface.

**Requires user role:** ADMIN

**Value space:** <Off/On>

*Off:* Set to Off to allow TLS connections without verifying them. The TLS connections are allowed to be set up without verifying the x.509 certificate received from the server against the local CA-list. This should typically be selected if no SIP CA-list has been uploaded.

*On:* Set to On to verify TLS connections. Only TLS connections to servers, whose x.509 certificate is validated against the CA-list, will be allowed.

**Example:** SIP Profile 1 TlsVerify: Off

### SIP Profile [1..1] Outbound

Turn on or off the client initiated connections mechanism for firewall traversal, connection reuse and redundancy. The current version supports RFC 5626.

**Requires user role:** ADMIN

**Value space:** <Off/On>

*Off:* Connect to the single proxy configured first in Proxy Address list.

*On:* Set up multiple outbound connections to servers in the Proxy Address list.

**Example:** SIP Profile 1 Outbound: Off

### SIP Profile [1..1] Proxy [1..4] Address

The Proxy Address is the manually configured address for the outbound proxy. It is possible to use a fully qualified domain name, or an IP address. The default port is 5060 for TCP and UDP but another one can be provided. If SIP Profile Outbound is enabled, multiple proxies can be addressed.

**Requires user role:** ADMIN

**Value space:** <S: 0, 255>

*Format:* A valid IPv4 address, IPv6 address or DNS name.

**Example:** SIP Profile 1 Proxy 1 Address: ""

### SIP Profile [1..1] Proxy [1..4] Discovery

Select if the SIP Proxy address is to be obtained manually or by using Dynamic Host Configuration Protocol (DHCP).

**Requires user role:** ADMIN

**Value space:** <Auto/Manual>

*Auto:* When Auto is selected, the SIP Proxy address is obtained using Dynamic Host Configuration Protocol (DHCP).

*Manual:* When Manual is selected, the manually configured SIP Proxy address will be used.

**Example:** SIP Profile 1 Proxy 1 Discovery: Manual

### SIP Profile [1..1] Type

Enables SIP extensions and special behaviour for a vendor or provider.

NOTE: The SIP types Alcatel, Avaya, Microsoft, and Nortel are no longer supported from software version TC6.3.

**Requires user role:** ADMIN

**Value space:** <Standard/Cisco>

*Standard:* Use this when registering to standard SIP Proxy (tested with Cisco TelePresence VCS and Broadsoft)

*Cisco:* Use this when registering to Cisco Unified Communication Manager.

**Example:** SIP Profile 1 Type: Standard

### SIP Profile [1..1] Mailbox

When registered to a Cisco Unified Communications Manager (CUCM) you may be offered the option of having a private voice mailbox. Enter the number (address) of the mailbox in this setting, or leave the string empty if you do not have a voice mailbox.

**Requires user role:** ADMIN

**Value space:** <S: 0, 255>>

*Format:* String with a maximum of 255 characters.

**Example:** SIP Profile 1 Mailbox: "12345678"

### SIP Profile [1..1] Line

When registered to a Cisco Unified Communications Manager (CUCM) the endpoint may be part of a shared line. This means that several devices share the same directory number. The different devices sharing the same number receive status from the other appearances on the line as defined in RFC 4235.

Note that shared lines are set up by CUCM, not by the endpoint. Therefore do not change this setting manually; CUCM pushes this information to the endpoint when required.

**Requires user role:** ADMIN

**Value space:** <Private/Shared>

*Shared:* The system is part of a shared line and is therefore sharing its directory number with other devices.

*Private:* This system is not part of a shared line (default).

**Example:** SIP Profile 1 Line: Private

## Standby settings

### Standby Control

Determine whether the system should go into standby mode or not.

**Requires user role:** ADMIN

**Value space:** <Off/On>

*Off:* The system will not enter standby mode.

*On:* Enter standby mode when the Standby Delay has timed out. NOTE: Requires the Standby Delay to be set to an appropriate value.

**Example:** Standby Control: On

### Standby Delay

Define how long (in minutes) the system shall be in idle mode before it goes into standby mode. NOTE: Requires the Standby Control to be enabled.

**Requires user role:** ADMIN

**Value space:** <1..480>

*Range:* Select a value from 1 to 480 minutes.

**Example:** Standby Delay: 10

### Standby BootAction

Define the camera position after a restart of the codec.

**Requires user role:** ADMIN

**Value space:** <None/Preset1/Preset2/Preset3/Preset4/Preset5/Preset6/Preset7/Preset8/Preset9/Preset10/Preset11/Preset12/Preset13/Preset14/Preset15/RestoreCameraPosition/DefaultCameraPosition>

*None:* No action.

*Preset1 to Preset15:* After a reboot the camera position will be set to the position defined by the selected preset.

*RestoreCameraPosition:* After a reboot the camera position will be set to the position it had before the last boot.

*DefaultCameraPosition:* After a reboot the camera position will be set to the factory default position.

**Example:** Standby BootAction: DefaultCameraPosition

### Standby StandbyAction

Define the camera position when going into standby mode.

**Requires user role:** ADMIN

**Value space:** <None/PrivacyPosition>

*None:* No action.

*PrivacyPosition:* Turns the camera to a sideways position for privacy.

**Example:** Standby StandbyAction: PrivacyPosition

### Standby WakeupAction

Define the camera position when leaving standby mode.

**Requires user role:** ADMIN

**Value space:** <None/Preset1/Preset2/Preset3/Preset4/Preset5/Preset6/Preset7/Preset8/Preset9/Preset10/Preset11/Preset12/Preset13/Preset14/Preset15/RestoreCameraPosition/DefaultCameraPosition>

*None:* No action.

*Preset1 to Preset15:* When leaving standby the camera position will be set to the position defined by the selected preset.

*RestoreCameraPosition:* When leaving standby the camera position will be set to the position it had before entering standby.

*DefaultCameraPosition:* When leaving standby the camera position will be set to the factory default position.

**Example:** Standby WakeupAction: RestoreCameraPosition



## SystemUnit settings

### SystemUnit Name

Enter a System Name to define a name of the system unit. If the H.323 Alias ID is configured on the system then this ID will be used instead of the system name. The system name will be displayed:

- 1) When the codec is acting as an SNMP Agent.
- 2) Towards a DHCP server.

**Requires user role:** ADMIN

**Value space:** <S: 0, 50>

*Format:* String with a maximum of 50 characters.

**Example:** SystemUnit Name: "Meeting Room"

### SystemUnit MenuLanguage

Select the language to be used in the menus on screen, or on the Touch controller. All languages are not supported on both user interfaces. The default language is English.

**Requires user role:** USER

**Value space:** <English/ChineseSimplified/ChineseTraditional/Catalan/Czech/Danish/Dutch/Finnish/French/German/Hungarian/Italian/Japanese/Korean/Norwegian/Polish/PortugueseBrazilian/Russian/Spanish/SpanishLatin/Swedish/Turkish/Arabic/Hebrew>

**Example:** SystemUnit MenuLanguage: English

### SystemUnit CallLogging Mode

Set the call logging mode for calls that are received or placed by the system. The call logs may then be viewed via the web interface or using the xHistory command.

**Requires user role:** ADMIN

**Value space:** <Off/On>

- Off:* Disable logging.
- On:* Enable logging.

**Example:** SystemUnit CallLogging Mode: On

### SystemUnit ContactInfo Type

Choose which type of contact information to show in the status field in the upper left corner of the main display and Touch controller. The information can also be read with the command xStatus SystemUnit ContactInfo.

**Requires user role:** ADMIN

**Value space:** <Auto/None/IPv4/IPv6/H323Id/E164Alias/H320Number/SipUri/SystemName/DisplayName>

*Auto:* Show the address which another system can dial to reach this system. The address depends on the default call protocol and system registration.

*None:* Do not show any contact information in the status field.

*IPv4:* Show the IPv4 address as contact information.

*IPv6:* Show the IPv6 address as contact information.

*H323Id:* Show the H.323 ID as contact information (see the H323 Profile [1..1] H323Alias ID setting).

*E164Alias:* Show the H.323 E164 Alias as contact information (see the H323 Profile [1..1] H323Alias E164 setting).

*H320Number:* Show the H.320 number as contact information (only applicable if connected to a Cisco TelePresence ISDN Link gateway).

*SipUri:* Show the SIP URI as contact information (see the SIP Profile [1..1] URI setting).

*SystemName:* Show the system name as contact information (see the SystemUnit Name setting).

*DisplayName:* Show the display name as contact information (see the SIP Profile [1..1] DisplayName setting).

**Example:** SystemUnit ContactInfo Type: Auto

## SystemUnit IrSensor

Both the Codec C Series and PrecisionHD camera have IR sensors, and only one of them needs to be enabled at the time. The IR sensor LED is located on the front of the codec and the camera and flickers when an IR signal is received from the remote control.

**Requires user role:** ADMIN

**Value space:** <Auto/Off/On>

*Auto:* The system will automatically disable the IR sensor on the codec if the IR sensor at camera is enabled. Otherwise, the IR sensor on the codec will be enabled.

*Off:* Disable the IR sensor on the codec.

*On:* Enable the IR sensor on the codec.

**Example:** SystemUnit IrSensor: Auto

## Time settings

### Time Zone

Set the time zone where the system is located, using Windows time zone description format.

**Requires user role:** USER

**Value space:** <GMT-12:00 (International Date Line West)/GMT-11:00 (Midway Island, Samoa)/GMT-10:00 (Hawaii)/GMT-09:00 (Alaska)/GMT-08:00 (Pacific Time (US & Canada); Tijuana)/GMT-07:00 (Arizona)/GMT-07:00 (Mountain Time (US & Canada))/GMT-07:00 (Chihuahua, La Paz, Mazatlan)/GMT-06:00 (Central America)/GMT-06:00 (Saskatchewan)/GMT-06:00 (Guadalajara, Mexico City, Monterrey)/GMT-06:00 (Central Time (US & Canada))/GMT-05:00 (Indiana (East))/GMT-05:00 (Bogota, Lima, Quito)/GMT-05:00 (Eastern Time (US & Canada))/GMT-04:30 (Caracas)/GMT-04:00 (La Paz)/GMT-04:00 (Santiago)/GMT-04:00 (Atlantic Time (Canada))/GMT-03:30 (Newfoundland)/GMT-03:00 (Buenos Aires, Georgetown)/GMT-03:00 (Greenland)/GMT-03:00 (Brasilia)/GMT-02:00 (Mid-Atlantic)/GMT-01:00 (Cape Verde Is.)/GMT-01:00 (Azores)/GMT (Casablanca, Monrovia)/GMT (Coordinated Universal Time)/GMT (Greenwich Mean Time : Dublin, Edinburgh, Lisbon, London)/GMT+01:00 (West Central Africa)/GMT+01:00 (Amsterdam, Berlin, Bern, Rome, Stockholm, Vienna)/GMT+01:00 (Brussels, Copenhagen, Madrid, Paris)/GMT+01:00 (Sarajevo, Skopje, Warsaw, Zagreb)/GMT+01:00 (Belgrade, Bratislava, Budapest, Ljubljana, Prague)/GMT+02:00 (Harare, Pretoria)/GMT+02:00 (Jerusalem)/GMT+02:00 (Athens, Istanbul, Minsk)/GMT+02:00 (Helsinki, Kyiv, Riga, Sofia, Tallinn, Vilnius)/GMT+02:00 (Cairo)/GMT+02:00 (Bucharest)/GMT+03:00 (Nairobi)/GMT+03:00 (Kuwait, Riyadh)/GMT+04:00 (Moscow, St. Petersburg, Volgograd)/GMT+03:00 (Baghdad)/GMT+03:30 (Tehran)/GMT+04:00 (Abu Dhabi, Muscat)/GMT+04:00 (Baku, Tbilisi, Yerevan)/GMT+04:30 (Kabul)/GMT+05:00 (Islamabad, Karachi, Tashkent)/GMT+05:00 (Ekaterinburg)/GMT+05:30 (Chennai, Kolkata, Mumbai, New Delhi)/GMT+05:45 (Kathmandu)/GMT+06:00 (Sri Jayawardenepura)/GMT+06:00 (Astana, Dhaka)/GMT+06:00 (Almaty, Novosibirsk)/GMT+06:30 (Rangoon)/GMT+07:00 (Bangkok, Hanoi, Jakarta)/GMT+07:00 (Krasnoyarsk)/GMT+08:00 (Perth)/GMT+08:00 (Taipei)/GMT+08:00 (Kuala Lumpur, Singapore)/GMT+08:00 (Beijing, Chongqing, Hong Kong, Urumqi)/GMT+08:00 (Irkutsk, Ulaan Bataar)/GMT+09:00 (Osaka, Sapporo, Tokyo)/GMT+09:00 (Seoul)/GMT+09:00 (Yakutsk)/GMT+09:30 (Darwin)/GMT+09:30 (Adelaide)/GMT+10:00 (Guam, Port Moresby)/GMT+10:00 (Brisbane)/GMT+10:00 (Vladivostok)/GMT+10:00 (Hobart)/GMT+10:00 (Canberra, Melbourne, Sydney)/GMT+11:00 (Magadan, Solomon Is., New Caledonia)/GMT+12:00 (Fiji, Kamchatka, Marshall Is.)/GMT+12:00 (Auckland, Wellington)/GMT+13:00 (Nuku alofa)>

*Range:* Select a time zone from the list time zones. If using a command line interface; watch up for typos.

**Example:** Time Zone: "GMT (Greenwich Mean Time : Dublin, Edinburgh, Lisbon, London)"

### Time TimeFormat

Set the time format.

**Requires user role:** USER

**Value space:** <24H/12H>

*24H:* Set the time format to 24 hours.

*12H:* Set the time format to 12 hours (AM/PM).

**Example:** Time TimeFormat: 24H

### Time DateFormat

Set the date format.

**Requires user role:** USER

**Value space:** <DD\_MM\_YY/MM\_DD\_YY/YY\_MM\_DD>

*DD\_MM\_YY:* The date January 30th 2010 will be displayed: 30.01.10

*MM\_DD\_YY:* The date January 30th 2010 will be displayed: 01.30.10

*YY\_MM\_DD:* The date January 30th 2010 will be displayed: 10.01.30

**Example:** Time DateFormat: DD\_MM\_YY

## UserInterface settings

### UserInterface TouchPanel DefaultPanel

Select whether to display the list of contacts, the list of scheduled meetings, or a dial pad on the Touch controller as default.

**Requires user role:** USER

**Value space:** <ContactList/MeetingList/Dialpad>

*ContactList:* The contact list (favorites, directory and history) will appear as default on the Touch controller.

*MeetingList:* The list of scheduled meetings will appear as default on the Touch controller.

*Dialpad:* A dial pad will appear as default on the Touch controller.

**Example:** UserInterface TouchPanel DefaultPanel: ContactList

## Video settings

### Video Input Source [1..3] Name

Enter a name for the video input source.

**Requires user role:** ADMIN

**Value space:** <S: 0, 50>

*Format:* String with a maximum of 50 characters.

**Example:** Video Input Source 1 Name: ""

### Video Input Source [1] Connector

Select which video input connector to be active on video input source 1.

**Requires user role:** ADMIN

**Value space:** <HDMI>

*HDMI:* Select HDMI when you want to use the HDMI 1 as input source 1.

**Example:** Video Input Source 1 Connector: HDMI

### Video Input Source [2] Connector

NOTE: Codec C40 has one DVI input (DVI-I 3). Codec C60 has two DVI inputs (DVI-I 2 and 3).

Select which video input connector to be active on video input source 2.

**Requires user role:** ADMIN

**Value space:** <HDMI/DVI>

*HDMI:* Select HDMI when you want to use the HDMI 2 as input source 2.

*DVI:* Select DVI-I when you want to use the DVI-I 2 as input source 2.

**Example:** Video Input Source 2 Connector: HDMI

### Video Input Source [3] Connector

NOTE: Codec C40 has one DVI input (DVI-I 3). Codec C60 has two DVI inputs (in this context, use DVI-I 3).

Select which video input connector to be active on video input source 3.

**Requires user role:** ADMIN

**Value space:** <DVI/Composite/YC>

*DVI:* Select DVI when you want to use the DVI-I 3 as input source 3.

*Composite:* Select Composite when you want to use the Composite as input source 3.

*YC:* Select YC when you want to use the S-Video (YC) as input source 3. Connect to the two connectors marked Y/Comp and C.

**Example:** Video Input Source 3 Connector: DVI

### Video Input Source [1..3] Type

Set which type of input source is connected to the video input.

**Requires user role:** ADMIN

**Value space:** <other/camera/PC/DVD/document\_camera>

*Other:* Select Other when some other type of equipment is connected to the selected video input.

*Camera:* Select Camera when you have a camera connected to the selected video input.

*PC:* Select PC when you have a PC connected to the selected video input.

*DVD:* Select DVD when you have a DVD player connected to the selected video input.

*Document\_Camera:* Select Document\_Camera when you have a document camera connected to the selected video input.

**Example:** Video Input Source 1 Type: PC

### Video Input Source [1..3] PresentationSelection

In general, any input source can be used as a presentation source; normally, the main camera (self view) will not be used as a presentation source.

This setting is used to define whether to display the presentation source on the local video system's display automatically or not. To share the presentation with the far end always requires additional action (tap Start Presenting on the Touch controller or the Presentation key on the remote control). The default value for all input sources is Manual.

**Requires user role:** ADMIN

**Value space:** <Manual/Automatic/Hidden>

*Manual:* The content on the input source will not be presented on the local video system's display before you select it. Use either the remote control or the Touch controller to choose which input source to present.

*Automatic:* Any content on the input source will be presented on the local video system's display automatically. If there is active content on more than one input source (which is set to Automatic) the most recent one will be used.

*Hidden:* The input source is not expected to be used as a presentation source.

**Example:** Video Input Source 1 PresentationSelection: Manual

### Video Input Source [1..3] CameraControl Mode

Select whether or not to enable camera control for the selected video input source when the video input is active.

**Requires user role:** ADMIN

**Value space:** <Off/On>

*Off:* Disable camera control.

*On:* Enable camera control.

**Example:** Video Input Source 1 CameraControl Mode: On

### Video Input Source [1..3] CameraControl CameraId

Select the ID of the camera in the Visca chain that is connected to this camera source. The CameraId setting represents the camera's position in the Visca chain.

**Requires user role:** ADMIN

**Value space:** <1/2/3/4/5/6/7>

*Range:* Select the ID of the camera in the Visca chain.

**Example:** Video Input Source 1 CameraControl CameraId: 1

### Video Input Source [1..3] OptimalDefinition Profile

The Video Input Source Quality setting must be set to Motion for the optimal definition settings to take any effect.

The optimal definition profile should reflect the lighting conditions in your room and the quality of the video input (camera); the better the lighting conditions and video input, the higher the profile. Then, in good lighting conditions, the video encoder will provide better quality (higher resolution or frame rate) for a given call rate.

Generally, we recommend using the Normal or Medium profiles. However, when the lighting conditions are good, the High profile can be set in order to increase the resolution for a given call rate.

Some typical resolutions used for different optimal definition profiles, call rates and transmit frame rates are shown in the table below. It is assumed that dual video is not used. The resolution must be supported by both the calling and called systems.

Use the Video Input Source OptimalDefinition Threshold60fps setting to decide when to use the 60 fps frame rate.

Typical resolutions used for different optimal definition profiles, call rates and frame rates								
Frame rate	Optimal Definition Profile	Call rate						
		256 kbps	768 kbps	1152 kbps	1472 kbps	2560 kbps	4 Mbps	6 Mbps
30 fps	Normal	512×288	1024×576	1280×720	1280×720	1920×1080	1920×1080	1920×1080
	Medium	640×360	1280×720	1280×720	1280×720	1920×1080	1920×1080	1920×1080
	High	768×448	1280×720	1280×720	1920×1080	1920×1080	1920×1080	1920×1080
60 fps	Normal	256×144	512×288	768×448	1024×576	1280×720	1280×720	1280×720*
	Medium	256×144	768×448	1024×576	1024×576	1280×720	1280×720*	1280×720*
	High	512×288	1024×576	1280×720	1280×720	1280×720*	1280×720*	1280×720*

\* The resolution will be 1920×1080 for 1080p60 capable C60 codecs (main board rev F and later).

**Requires user role:** ADMIN

**Value space:** <Normal/Medium/High>

*Normal:* Use this profile for a normally to poorly lit environment. Resolutions will be set rather conservative.

*Medium:* Requires good and stable lighting conditions and a good quality video input. For some call rates this leads to higher resolution.

*High:* Requires nearly optimal video conferencing lighting conditions and a good quality video input in order to achieve a good overall experience. Rather high resolutions will be used.

**Example:** Video Input Source 1 OptimalDefinition Profile: Normal

### Video Input Source [1..3] OptimalDefinition Threshold60fps

For each video input, this setting tells the system the lowest resolution where it should transmit 60fps. So for all resolutions lower than this, the maximum transmitted framerate would be 30fps, while above this resolution 60fps would also be possible, if the available bandwidth is adequate.

**Requires user role:** ADMIN

**Value space:** <512\_288/768\_448/1024\_576/1280\_720/1920\_1080/Never>

*512\_288:* Set the threshold to 512x288.

*768\_448:* Set the threshold to 768x448.

*1024\_576:* Set the threshold to 1024x576.

*1280\_720:* Set the threshold to 1280x720.

*1920\_1080:* Set the threshold to 1920x1080.

*Never:* Do not set a threshold for transmitting 60fps.

**Example:** Video Input Source 1 OptimalDefinition Threshold60fps: 1280\_720

### Video Input Source [1..3] Quality

When encoding and transmitting video there will be a trade-off between high resolution and high framerate. For some video sources it is more important to transmit high framerate than high resolution and vice versa. The Quality setting specifies whether to give priority to high frame rate or to high resolution for a given source.

**Requires user role:** ADMIN

**Value space:** <Motion/Sharpness>

*Motion:* Gives the highest possible framerate. Used when there is a need for higher frame rates, typically when a large number of participants are present or when there is a lot of motion in the picture.

*Sharpness:* Gives the highest possible resolution. Used when you want the highest quality of detailed images and graphics.

**Example:** Video Input Source 1 Quality: Motion

### Video MainVideoSource

Define which video input source shall be used as the main video source.

**Requires user role:** USER

**Value space:** <1/2/3>

*Range:* Select the source to be used as the main video source.

**Example:** Video MainVideoSource: 1

### Video DefaultPresentationSource

Define which video input source shall be used as the default presentation source when you press the Presentation key on the remote control. If using a Touch controller this setting has no effect. The Video Input Source n Connector setting defines which input connector to use for input source n.

**Requires user role:** USER

**Value space:** <1/2/3>

*Range:* Select the video source to be used as the presentation source.

**Example:** Video DefaultPresentationSource: 3

### Video Input HDMI [1..2] RGBQuantizationRange

All devices with HDMI inputs should follow the rules for RGB video quantization range defined in CEA-861. Unfortunately some devices do not follow the standard and this configuration may be used to override the settings to get a perfect image with any source.

**Requires user role:** ADMIN

**Value space:** <Auto/Full/Limited>

*Auto:* RGB quantization range is automatically selected based on the RGB Quantization Range bits (Q0, Q1) in the AVI infoframe. If no AVI infoframe is available, RGB quantization range is selected based on video format according to CEA-861-E.

*Full:* Full quantization range. The R, G, B quantization range includes all code values (0 - 255). This is defined in CEA-861-E.

*Limited:* Limited Quantization Range. R, G, B quantization range that excludes some code values at the extremes (16 - 235). This is defined in CEA-861-E.

**Example:** Video Input 1 HDMI 1 RGBQuantizationRange: Auto

### Video Input DVI [3]/[2,3] RGBQuantizationRange

NOTE: Codec C40 has one DVI input (DVI-I 3). Codec C60 has two DVI inputs (DVI-I 2 and 3). All devices with DVI inputs should follow the rules for RGB video quantization range defined in CEA-861. Unfortunately some devices do not follow the standard and this configuration may be used to override the settings to get a perfect image with any source. The default value is set to Full because most DVI sources expects full quantization range.

**Requires user role:** ADMIN

**Value space:** <Auto/Full/Limited>

*Auto:* RGB quantization range is automatically selected based on video format according to CEA-861-E. CE video formats will use limited quantization range levels. IT video formats will use full quantization range levels.

*Full:* Full quantization range. The R, G, B quantization range includes all code values (0 - 255). This is defined in CEA-861-E.

*Limited:* Limited Quantization Range. R, G, B quantization range that excludes some code values at the extremes (16 - 235). This is defined in CEA-861-E.

**Example:** Video Input 1 DVI 3 RGBQuantizationRange: Full

### Video Input DVI [3]/[2,3] Type

NOTE: Codec C40 has one DVI input (DVI-I 3). Codec C60 has two DVI inputs (DVI-I 2 and 3). The official DVI standard supports both digital and analog signals. In most cases the default AutoDetect setting can detect whether the signal is analog RGB or digital. However, in some rare cases when DVI-I cables are used (these cables can carry both the analog and digital signals) the auto detection fails. This setting makes it possible to override the AutoDetect and select the correct DVI video input.

This setting should also be used if the video input is an analog component (YPbPr) type signal. This is used by some cameras (Sony EVI-HD1) and DVD/Blu-ray players. Since it is not possible to auto detect the difference between AnalogRGB and AnalogYPbPr, the AnalogYPbPr setting must be selected.

**Requires user role:** ADMIN

**Value space:** <AutoDetect/Digital/AnalogRGB/AnalogYPbPr>

*AutoDetect:* Set to AutoDetect to automatically detect if the signal is analog RGB or digital.

*Digital:* Set to Digital to force the DVI video input to Digital when using DVI-I cables with both analog and digital pins and AutoDetect fails.

*AnalogRGB:* Set to AnalogRGB to force the DVI video input to AnalogRGB when using DVI-I cables with both analog and digital pins and AutoDetect fails.

*AnalogYPbPr:* Set to AnalogYPbPr to force the DVI video input to AnalogYPbPr, as the component (YPbPr) signal cannot be auto detected.

**Example:** Video Input DVI 3 Type: AutoDetect

### Video Layout Scaling

Define how the system shall adjust the aspect ratio for images or frames when there is a difference between the image and the frame it is to be placed in.

**Requires user role:** ADMIN

**Value space:** <Off/On>

*Off:* No adjustment of the aspect ratio.

*On:* Let the system automatically adjust aspect ratio.

**Example:** Video Layout Scaling: On



## Video Layout ScaleToFrame

Define what to do if the aspect ratio of a video input source doesn't match the aspect ratio of the corresponding image frame in a composition. For example if you have a 4:3 input source (like XGA) to be displayed on a 16:9 output (like HD720).

**Requires user role:** ADMIN

**Value space:** <Manual/MaintainAspectRatio/StretchToFit>

*Manual:* If the difference in aspect ratio between the video input source and the target image frame is less than the Video Layout ScaleToFrameThreshold setting (in percent), the image is stretched to fit. If not, the system will maintain the original aspect ratio.

*MaintainAspectRatio:* Maintain the aspect ratio of the input source, and fill in black in the rest of the frame (letter boxing or pillar boxing).

*StretchToFit:* Stretch (horizontally or vertically) the input source to fit into the image frame. NOTE: The general limitation is that you cannot upscale in one direction and at the same time downscale in the other direction. In such situations the codec will apply letterboxing.

**Example:** Video Layout ScaleToFrame: MaintainAspectRatio

## Video Layout ScaleToFrameThreshold

Only applicable if the Video Layout ScaleToFrame setting is set to manual. If the difference in aspect ratio between the video input source and the target image frame is less than the ScaleToFrameThreshold setting (in percent), the image is stretched to fit. If not, the system will maintain the original aspect ratio.

**Requires user role:** ADMIN

**Value space:** <0..100>

*Range:* Select a value from 0 to 100 percent.

**Example:** Video Layout ScaleToFrameThreshold: 5

## Video Selfview

Determine if the main video source (self view) shall be displayed on screen.

This setting is obsolete by the Video SelfviewDefault Mode setting as from TC6.0.

**Requires user role:** USER

**Value space:** <Off/On>

*Off:* Do not display self view on screen.

*On:* Display self view on screen.

**Example:** Video Selfview: On

## Video SelfviewPosition

Select where the small self view PiP (Picture-in-Picture) will appear on screen.

This setting is obsolete by the Video SelfviewDefault PiPPosition setting as from TC6.0.

**Requires user role:** ADMIN

**Value space:** <UpperLeft/UpperCenter/UpperRight/CenterLeft/CenterRight/LowerLeft/LowerRight>

*UpperLeft:* The self view PiP will appear in the upper left corner of the screen.

*UpperCenter:* The self view PiP will appear in the upper center of the screen.

*UpperRight:* The self view PiP will appear in the upper right corner of the screen.

*CenterLeft:* The self view PiP will appear on the left side of the screen, in center.

*CenterRight:* The self view PiP will appear on the right side of the screen, in center.

*LowerLeft:* The self view PiP will appear in the lower left corner of the screen.

*LowerRight:* The self view PiP will appear in the lower right corner of the screen.

**Example:** Video SelfviewPosition: LowerRight

## Video SelfviewController AutoResizing

The size of the self view frame can be configured to automatically change according to the following rules. The size is reduced from full screen to PiP (picture-in-picture) when there is a change in a frame that overlaps with the self view frame. The size is increased from PiP to full screen when nothing else is displayed on the monitor. The last rule does not apply to monitors with MonitorRole set to First.

**Requires user role:** ADMIN

**Value space:** <Off/On>

*Off:* Self view will not be automatically resized.

*On:* Self view is automatically resized as described above.

**Example:** Video SelfviewController AutoResizing: On

### Video SelfviewDefault Mode

Determine if the main video source (self view) shall be displayed on screen after a call. The position and size of the self view window is determined by the Video SelfviewDefault PIPPosition and the Video Selfview FullscreenMode settings respectively.

This setting obsoletes the Video Selfview setting as from TC6.0.

**Requires user role:** ADMIN

**Value space:** <Off/Current/On>

*Off:* Self view is switched off when leaving a call.

*Current:* Self view is left as is, i.e. if it was on during the call, it remains on after the call; if it was off during the call, it remains off after the call.

*On:* Self view is switched on when leaving a call.

**Example:** Video SelfviewDefault Mode: Current

### Video SelfviewDefault FullscreenMode

Determine if the main video source (self view) shall be shown in full screen or as a small picture-in-picture (PiP) after a call. The setting only takes effect when self view is switched on (see the Video SelfviewDefault Mode setting).

**Requires user role:** ADMIN

**Value space:** <Off/Current/On>

*Off:* Self view will be shown as a PiP.

*Current:* The size of the self view picture will be kept unchanged when leaving a call, i.e. if it was a PiP during the call, it remains a PiP after the call; if it was fullscreen during the call, it remains fullscreen after the call.

*On:* The self view picture will be shown in fullscreen.

**Example:** Video SelfviewDefault FullscreenMode: Current

### Video SelfviewDefault PIPPosition

Determine the position on screen of the small self view picture-in-picture (PiP) after a call. The setting only takes effect when self view is switched on (see the Video SelfviewDefault Mode setting) and fullscreen view is switched off (see the Video SelfviewDefault FullscreenMode setting).

This setting obsoletes the Video SelfviewPosition setting as from TC6.0.

**Requires user role:** ADMIN

**Value space:** <Current/UpperLeft/UpperCenter/UpperRight/CenterLeft/CenterRight/LowerLeft/LowerRight >

*Current:* The position of the self view PiP will be kept unchanged when leaving a call.

*UpperLeft:* The self view PiP will appear in the upper left corner of the screen.

*UpperCenter:* The self view PiP will appear in the upper center position.

*UpperRight:* The self view PiP will appear in the upper right corner of the screen.

*CenterLeft:* The self view PiP will appear in the center left position.

*CenterRight:* The self view PiP will appear in the center right position.

*LowerLeft:* The self view PiP will appear in the lower left corner of the screen.

*LowerRight:* The self view PiP will appear in the lower right corner of the screen.

**Example:** Video SelfviewDefault PIPPosition: Current

### Video SelfviewDefault OnMonitorRole

Determine which monitor/output to display the main video source (self view) on after a call. The value reflects the monitor roles set for the different outputs in the Video Output HDMI/DVI/Composite MonitorRole settings.

The setting applies both when self view is displayed in full screen, and when it is displayed as picture-in-picture (PiP), but only if the Video Monitors setting is set to Dual.

**Requires user role:** ADMIN

**Value space:** <First/Second/Current>

*First:* The self view picture will be shown on outputs with the Video Output HDMI/DVI/Composite MonitorRole set to First.

*Second:* The self view picture will be shown on outputs with the Video Output HDMI/DVI/Composite MonitorRole set to Second.

*Current:* When leaving the call, the self view picture will be kept on the same output as during the call.

**Example:** Video SelfviewDefault OnMonitorRole: Current

### Video CamCtrlPip CallSetup Mode

This setting is used to switch on self view for a short while when setting up a call. The Video CamCtrlPip CallSetup Duration setting determines for how long it remains on. This applies when self view in general is switched off.

**Requires user role:** ADMIN

**Value space:** <Off/On>

*Off:* Self view is not shown automatically during call setup.

*On:* Self view is shown automatically during call setup.

**Example:** Video CamCtrlPip CallSetup Mode: Off

### Video CamCtrlPip CallSetup Duration

This setting only has an effect when the Video CamCtrlPip CallSetup Mode setting is switched On. In this case, the number of seconds set here determines for how long self view is shown before it is automatically switched off.

**Requires user role:** ADMIN

**Value space:** <1..60>

*Range:* Choose for how long self view remains on. The valid range is between 1 and 60 seconds.

**Example:** Video CamCtrlPip CallSetup Duration: 10

### Video PIP ActiveSpeaker DefaultValue Position

Determine the position on screen of the active speaker picture-in-picture (PiP). The setting only takes effect when using a video layout where the active speaker is a PiP, i.e. the Overlay layout, or possibly a Custom layout (see the Video Layout LocalLayoutFamily setting). The setting takes effect from the next call onwards; if changed during a call, it will have no effect on the current call.

**Requires user role:** ADMIN

**Value space:** <Current/UpperLeft/UpperCenter/UpperRight/CenterLeft/CenterRight/LowerLeft/LowerRight>

*Current:* The position of the active speaker PiP will be kept unchanged when leaving a call.

*UpperLeft:* The active speaker PiP will appear in the upper left corner of the screen.

*UpperCenter:* The active speaker PiP will appear in the upper center position.

*UpperRight:* The active speaker PiP will appear in the upper right corner of the screen.

*CenterLeft:* The active speaker PiP will appear in the center left position.

*CentreRight:* The active speaker PiP will appear in the center right position.

*LowerLeft:* The active speaker PiP will appear in the lower left corner of the screen.

*LowerRight:* The active speaker PiP will appear in the lower right corner of the screen.

**Example:** Video PIP ActiveSpeaker DefaultValue Position: Current

### Video PIP Presentation DefaultValue Position

Determine the position on screen of the presentation picture-in-picture (PiP). The setting only takes effect when the presentation is explicitly minimized to a PiP, for example using the remote control or the Touch controller. The setting takes effect from the next call onwards; if changed during a call, it will have no effect on the current call.

**Requires user role:** ADMIN

**Value space:** <Current/UpperLeft/UpperCenter/UpperRight/CenterLeft/CenterRight/LowerLeft/LowerRight>

*Current:* The position of the presentation PiP will be kept unchanged when leaving a call.

*UpperLeft:* The presentation PiP will appear in the upper left corner of the screen.

*UpperCenter:* The presentation PiP will appear in the upper center position.

*UpperRight:* The presentation PiP will appear in the upper right corner of the screen.

*CenterLeft:* The presentation PiP will appear in the center left position.

*CentreRight:* The presentation PiP will appear in the center right position.

*LowerLeft:* The presentation PiP will appear in the lower left corner of the screen.

*LowerRight:* The presentation PiP will appear in the lower right corner of the screen.

**Example:** Video PIP Presentation DefaultValue Position: Current

### Video Layout DisableDisconnectedLocalOutputs

Prevent the built-in layout engine from setting layouts on local outputs that have no monitor connected.

**Requires user role:** ADMIN

**Value space:** <Off/On>

*Off:* The built-in layout engine sets layout on all local outputs, also the ones not having any monitor connected.

*On:* The built-in layout engine does only set layout on local outputs having a monitor connected.

**Example:** Video Layout DisableDisconnectedLocalOutputs: Off

### Video Layout Engine LocalMode

Sets the operating mode of the built-in layout engine.

**Requires user role:** ADMIN

**Value space:** <Disabled/Enabled/DisabledPIPs>

*Disabled:* The built-in layout engine does not display any frames in the layout on the local output.

*Enabled:* The built-in layout engine displays all frames in the layout on all local outputs.

*DisabledPIPs:* The built-in layout engine does not display any PIP frame in the layout on the local output.

**Example:** Video Layout Engine LocalMode: Enabled

### Video Layout LocalLayoutFamily

Select which video layout family to use locally.

**Requires user role:** ADMIN

**Value space:** <Auto/FullScreen/Equal/PresentationSmallSpeaker/PresentationLargeSpeaker/Prominent/Overlay/Single>

*Auto:* The default layout family, as given by the layout database, will be used as the local layout. For more information about the layout database, see the xCommand Video Layout LoadDb command.

*FullScreen:* The FullScreen layout family will be used as the local layout. It means that the active speaker or presentation will be shown in full screen. Using this value is not recommended as from TC6.0.

*Equal:* The Equal layout family will be used as the local layout. All videos have equal size, as long as there is space enough on the screen(s).

*PresentationSmallSpeaker:* The PresentationSmallSpeaker layout family will be used as the local layout. Using this value is not recommended as from TC6.0.

*PresentationLargeSpeaker:* The PresentationLargeSpeaker layout family will be used as the local layout. Using this value is not recommended as from TC6.0.

*Prominent:* The Prominent layout family will be used as the local layout. The active speaker, or the presentation if present, will be a large picture, while the other participants will be small pictures. Transitions between active speakers are voice switched.

*Overlay:* The Overlay layout family will be used as the local layout. The active speaker, or the presentation if present, will be shown in full screen, while the other participants will be small pictures-in-picture (PiP). Transitions between active speakers are voice switched.

*Single:* The active speaker, or the presentation if present, will be shown in full screen. The other participants are not shown. Transitions between active speakers are voice switched.

**Example:** Video Layout LocalLayoutFamily: Auto

### Video Layout PresentationDefault View

Determine how the presentation will show on screen when you start sharing a presentation.

**Requires user role:** ADMIN

**Value space:** <Default/Minimized/Maximized>

*Default:* The presentation is a part of the layout.

*Minimized:* The presentation starts up in PIP mode.

*Maximized:* The presentation starts up in full screen mode.

**Example:** Video Layout PresentationDefault View: Default

## Video Layout RemoteLayoutFamily

Select which video layout family to be used for the remote participants.

**Requires user role:** ADMIN

**Value space:** <Auto/FullScreen/Equal/PresentationSmallSpeaker/PresentationLargeSpeaker/Prominent/Overlay/Single>

*Auto:* The default layout family, as given by the local layout database, will be used as the remote layout. For more information about the layout database, see the command: xCommand Video Layout LoadDb.

*FullScreen:* The FullScreen layout family will be used as the remote layout. It means that the active speaker or presentation will be shown in full screen. Using this value is not recommended as from TC6.0.

*Equal:* The Equal layout family will be used as the remote layout. All videos have equal size, as long as there is space enough on the screen.

*PresentationSmallSpeaker:* The PresentationSmallSpeaker layout family will be used as the remote layout. Using this value is not recommended as from TC6.0.

*PresentationLargeSpeaker:* The PresentationLargeSpeaker layout family will be used as the remote layout. Using this value is not recommended as from TC6.0.

*Prominent:* The Prominent layout family will be used as the remote layout. The active speaker, or the presentation if present, will be a large picture, while the other participants will be small pictures. Transitions between active speakers are voice switched.

*Overlay:* The Overlay layout family will be used as the remote layout. The active speaker, or the presentation if present, will be shown in full screen, while the other participants will be small pictures-in-picture (PiP). Transitions between active speakers are voice switched.

*Single:* The active speaker, or the presentation if present, will be shown in full screen. The other participants are not shown. Transitions between active speakers are voice switched.

**Example:** Video Layout RemoteLayoutFamily: Auto

## Video Monitors

Set the monitor layout mode.

**Requires user role:** ADMIN

**Value space:** <Single/Dual/DualPresentationOnly>

*Single:* The same layout is shown on all monitors.

*Dual:* The layout is distributed on two monitors.

*DualPresentationOnly:* All participants in the call will be shown on the first monitor, while the presentation (if any) will be shown on the second monitor.

**Example:** Video Monitors: Single

## Video OSD Mode

The Video OSD (On Screen Display) Mode lets you define if information and icons should be displayed on screen.

**Requires user role:** ADMIN

**Value space:** <Off/On>

*Off:* Hide the on screen menus, icons and indicators.

*On:* Display the on screen menus, icons and indicators.

**Example:** Video OSD Mode: On

## Video OSD WallpaperSelection

Applies to the on screen menu (OSD). The wall paper selection menu can be hidden outside the administrator settings menu and visible inside, or it can be visible both inside and outside the administrator settings menu. The administrator settings menu can be password protected.

**Requires user role:** ADMIN

**Value space:** <Off/On>

*Off:* The wall paper selection menu is hidden outside the administrator settings menu and visible inside. To change the wallpaper, navigate to: Home > Settings > Administrator Settings. If required log in with your username and password. Then navigate to Wall Paper.

*On:* The wall paper selection menu is visible both inside and outside the administrator settings menu. To change the wallpaper, navigate to: Home > Settings > Wall Paper. Or navigate to Home > Settings > Administrator Settings. If required log in with your username and password. Then navigate to Wall Paper.

**Example:** Video OSD WallpaperSelection: On

## Video OSD LanguageSelection

Applies to the on screen menu (OSD). The language selection menu can be hidden outside the administrator settings menu and visible inside, or it can be visible both inside and outside the administrator settings menu. The administrator settings menu can be password protected.

**Requires user role:** ADMIN

**Value space:** <Off/On>

*Off:* The language selection menu is hidden outside the administrator settings menu and visible inside. To change the language, navigate to: Home > Settings > Administrator Settings. If required log in with your username and password. Then navigate to Language.

*On:* The language selection menu is visible both inside and outside the administrator settings menu. To change the language, navigate to: Home > Settings > Language. Or navigate to Home > Settings > Administrator Settings. If required log in with your username and password. Then navigate to Language.

**Example:** Video OSD LanguageSelection: On

## Video OSD MenuStartupMode

Configures the state of the OSD (On Screen Display) menu after a video system / codec boot. The setting only applies when the video system is operated by a remote control and the on-screen menu.

**Requires user role:** ADMIN

**Value space:** <Closed/Home>

*Closed:* The OSD menu will NOT expand automatically. This setting is recommended for 3rd party integrations that need full control of what is shown on the OSD.

*Home:* The OSD menu will show the home menu expanded.

**Example:** Video OSD MenuStartupMode: Home

## Video OSD VirtualKeyboard

Determine whether or not the virtual keyboard will automatically show on screen when text is to be entered in an input field. The setting only applies when the video system is operated by a remote control and the on-screen menu.

**Requires user role:** ADMIN

**Value space:** <UserSelectable/AlwaysOn>

*UserSelectable:* The user has to press a softbutton to open or close the virtual keyboard.

*AlwaysOn:* The virtual keyboard is automatically shown on screen as long as text can be entered in an input field.

**Example:** Video OSD VirtualKeyboard: UserSelectable

## Video OSD EncryptionIndicator

Define for how long the encryption indicator (a padlock) will be shown on screen. The setting applies to both encrypted and non-encrypted calls, i.e. both to secure and non-secure conferences. The icon for encrypted calls is a locked padlock, and the icon for non-encrypted calls is a crossed out locked padlock.

**Requires user role:** ADMIN

**Value space:** <Auto/AlwaysOn/AlwaysOff>

*Auto:* If the Conference Encryption Mode setting is set to BestEffort and the call is encrypted, the encryption indicator is shown during the first seconds of a call. If the Conference Encryption Mode setting is set to BestEffort and the call is non-encrypted, the crossed out encryption indicator is shown during the entire call. If the Conference Encryption Mode setting is NOT set to BestEffort, the encryption indicator is not shown at all.

*AlwaysOn:* The encryption indicator is displayed on screen during the entire call. This applies to both encrypted and non-encrypted calls for all Conference Encryption Mode settings.

*AlwaysOff:* The encryption indicator is never displayed on screen. This applies to both encrypted and non-encrypted calls for all Conference Encryption Mode settings.

**Example:** Video OSD EncryptionIndicator: Auto

### Video OSD MissedCallsNotification

Determine whether or not the OSD (On Screen Display) shall display a missed calls notification dialog box if there have been incoming calls that have not been answered. The setting only applies when the video system is operated by a remote control and the on-screen menu. When using a Touch controller the notification dialog box will appear on the Touch display, and not on the OSD.

**Requires user role:** ADMIN

**Value space:** <Off/On>

*Off:* The OSD will NOT show any indication that there have been any missed calls. This setting is recommended for 3rd party integrations that need full control of what is shown on the OSD.

*On:* The OSD will show a notification of missed calls.

**Example:** Video OSD MissedCallsNotifications: On

### Video OSD AutoSelectPresentationSource

Determine if the presentation source should be automatically selected.

**Requires user role:** ADMIN

**Value space:** <Off/On>

*Off:* Disable automatic selection of the presentation source.

*On:* Enable automatic selection of the presentation source.

**Example:** Video OSD AutoSelectPresentationSource: Off

### Video OSD CallSettingsSelection

In cases where you want to prevent users from changing the call settings from the on-screen menus, the Call Settings sub menu can be hidden.

**Requires user role:** ADMIN

**Value space:** <Off/On>

*Off:* The Call Settings sub menu will be hidden.

*On:* The Call Settings sub menu will be visible.

**Example:** Video OSD CallSettingsSelection: Off

### Video OSD TodaysBookings

This setting can be used to display the system's bookings for today on the main OSD menu. This requires that the system is bookable by an external booking system, like Cisco TelePresence Management Suite (TMS).

**Requires user role:** ADMIN

**Value space:** <Off/On>

*Off:* Do not display todays bookings.

*On:* Displays information about this systems bookings on screen.

**Example:** Video OSD TodaysBookings: Off

### Video OSD MyContactsExpanded

Set how the local contacts will be displayed in the phone book dialog in the OSD (On Screen Display).

**Requires user role:** ADMIN

**Value space:** <Off/On>

*Off:* The local contacts will be placed in a separate folder called MyContacts in the phonebook dialog.

*On:* The local contacts in the phone book will be shown in the top level of the phonebook dialog.

**Example:** Video OSD MyContactsExpanded: Off

### Video OSD Output

The Video OSD (On Screen Display) Output lets you define which monitor should display the on-screen menus, information and icons.

**Requires user role:** ADMIN

**Value space:** <Auto/1/2>

*Auto:* The system will detect when a monitor is connected to the video output, and send the OSD to the first monitor you connect. If you have a multi-monitor setup, and all monitors are connected before switching on the system, the OSD will be sent to the video output with the lowest numbering, starting on Video OSD Output 1. If the OSD does not show on the desired monitor, disconnect all monitors and reconnect the monitors.

*Range 1-2:* If you want the OSD to be sent to one specific output, select 1 for HDMI 1 output, or select 2 for DVI-I 2 output. Make sure you connect a monitor to the corresponding video output connector.

**Example:** Video OSD Output: Auto

## Video OSD InputMethod InputLanguage

The codec can be enabled for Cyrillic input characters in the menus on screen. NOTE: Requires that Video OSD inputMethod Cyrillic is set to On.

**Requires user role:** ADMIN

**Value space:** <Latin/Cyrillic>

*Latin:* Latin characters can be entered when using the remote control (default).

*Cyrillic:* Cyrillic characters can be entered using the remote control. NOTE: Requires a Cisco TelePresence Remote Control with Cyrillic fonts.

**Example:** Video OSD InputMethod InputLanguage: Latin

## Video OSD InputMethod Cyrillic

Set the Cyrillic mode for the menu input language in the menus on screen.

**Requires user role:** ADMIN

**Value space:** <Off/On>

*Off:* Cyrillic mode is NOT available as a menu input language in the menus on screen.

*On:* Cyrillic mode is available as a menu input language in the menus on screen. This will enable the setting Video OSD InputMethod InputLanguage.

**Example:** Video OSD InputMethod Cyrillic: Off

## Video OSD LoginRequired

Determine if the system should require the user to login before accessing the On Screen Display (OSD). If enabled, the user must enter his username and his PIN code. After the user has logged in he can only execute to the configurations changes and commands allowed by his role.

NOTE: The PIN code must be set before enabling this setting, this is done from a web interface. Login to the system from a web browser, navigate to Configuration > User Administration, select the user and add the PIN code.

**Requires user role:** ADMIN

**Value space:** <Off/On>

*Off:* No login to the OSD is required.

*On:* The user must log in to access the On Screen Display (OSD).

**Example:** Video OSD LoginRequired: Off

## Video AllowWebSnapshots

Allow or disallow snapshots being taken of the local input sources, remote sites and presentation channel. If allowed, the web interface Call Control page will show snapshots both when idle and in a call.

NOTE: This feature is disabled by default, and must be enabled from the On Screen Display (OSD), from a directly connected Touch controller, or via the codec's serial port (COM).

**Requires user role:** ADMIN

**Value space:** <Off/On>

*Off:* Capturing web snapshots is not allowed.

*On:* Web snapshots can be captured and displayed on the web interface.

**Example:** Video AllowWebSnapshots: Off

## Video Output HDMI [1] RGBQuantizationRange

All devices with HDMI outputs should follow the rules for RGB video quantization range defined in CEA-861. Unfortunately some devices do not follow the standard and this configuration may be used to override the settings to get a perfect image with any display. The default value is set to Full because most HDMI displays expects full quantization range.

**Requires user role:** ADMIN

**Value space:** <Auto/Full/Limited>

*Auto:* RGB quantization range is automatically selected based on the RGB Quantization Range bits (Q0, Q1) in the AVI infoframe. If no AVI infoframe is available, RGB quantization range is selected based on video format according to CEA-861-E.

*Full:* Full quantization range. The R, G, B quantization range includes all code values (0 - 255). This is defined in CEA-861-E.

*Limited:* Limited Quantization Range. R, G, B quantization range that excludes some code values at the extremes (16 - 235). This is defined in CEA-861-E.

**Example:** Video Output HDMI 1 RGBQuantizationRange: Full



### Video Output HDMI [1] CEC Mode

The HDMI outputs support Consumer Electronics Control (CEC). When set to on (default is off), and the monitor connected to the HDMI output is CEC compatible and CEC is configured, the system will use CEC to set the monitor in standby when the system enters standby. Likewise the system will wake up the monitor when the system wakes up from standby. Please note that the different manufacturers uses different marketing names for CEC, for example Anynet+ (Samsung); Aquos Link (Sharp); BRAVIA Sync (Sony); HDMI-CEC (Hitachi); Kuro Link (Pioneer); CE-Link and Regza Link (Toshiba); RIHD (Onkyo); HDAVI Control, EZ-Sync, VIERA Link (Panasonic); EasyLink (Philips); and NetCommand for HDMI (Mitsubishi).

**Requires user role:** ADMIN

**Value space:** <Off/On>

*Off:* Disable CEC control.

*On:* Enable CEC control.

**Example:** Video Output HDMI 1 CEC Mode: Off

### Video Output HDMI [1] MonitorRole

The HDMI monitor role describes which video stream will be shown on the monitor connected to the video output HDMI connector.

**Requires user role:** ADMIN

**Value space:** <Auto/First/Second/PresentationOnly/Recorder>

*Auto:* The system will detect when a monitor is connected and assign a monitor role to it. The first monitor connected will be assigned monitor role First. In a multi-monitor setup the next monitor will be assigned monitor role Second.

*First/Second:* Define the role of the monitor in a multi-monitor setup. In a single-monitor setup, there is no difference between First and Second.

*PresentationOnly:* Show presentation video stream if active, and nothing else.

*Recorder:* Show all participants, including the local main video. If active, also show the presentation.

**Example:** Video Output HDMI 1 MonitorRole: Auto

### Video Output HDMI [1] OverscanLevel

Some TVs or other monitors may not display the whole image sent out on the systems video output, but cuts the outer parts of the image. In this case this setting can be used to let the system not use the outer parts of video resolution. Both the video and the OSD menu will be scaled in this case.

**Requires user role:** ADMIN

**Value space:** <Medium/High/None>

*Medium:* The system will not use the outer 3% of the output resolution.

*High:* The system will not use the outer 6% of the output resolution

*None:* The system will use all of the output resolution.

**Example:** Video Output HDMI 1 OverscanLevel: None

### Video Output HDMI [1] Resolution

Select the preferred resolution for the monitor connected to the video output HDMI connector. This will force the resolution on the monitor.

**Requires user role:** ADMIN

**Value space:** <Auto/640\_480\_60/800\_600\_60/1024\_768\_60/1280\_1024\_60/1280\_720\_50/1280\_720\_60/1920\_1080\_50/1920\_1080\_60/1280\_768\_60/1360\_768\_60/1366\_768\_60/1600\_1200\_60/1680\_1050\_60/1920\_1200\_60>

*Auto:* The system will automatically try to set the optimal resolution based on negotiation with the connected monitor.

*Range:* 640x480@60p, 800x600@60p, 1024x768@60p, 1280x1024@60p, 1280x720@50p, 1280x720@60p, 1920x1080@50p, 1920x1080@60p, 1280x768@60p, 1360x768@60p, 1366x768@60p, 1600x1200@60p, 1680x1050@60p, 1920x1200@60p

**Example:** Video Output HDMI 1 Resolution: Auto

## Video Output DVI [2] RGBQuantizationRange

All devices with DVI outputs should follow the rules for RGB video quantization range defined in CEA-861. Unfortunately some devices do not follow the standard and this configuration may be used to override the settings to get a perfect image with any display. The default value is set to Full because most DVI displays expects full quantization range.

**Requires user role:** ADMIN

**Value space:** <Auto/Full/Limited>

*Auto:* RGB quantization range is automatically selected based on video format according to CEA-861-E. CE video formats will use limited quantization range levels. IT video formats will use full quantization range levels.

*Full:* Full quantization range. The R, G, B quantization range includes all code values (0 - 255). This is defined in CEA-861-E.

*Limited:* Limited Quantization Range. R, G, B quantization range that excludes some code values at the extremes (16 - 235). This is defined in CEA-861-E.

**Example:** Video Output DVI 2 RGBQuantizationRange: Full

## Video Output DVI [2] MonitorRole

The DVI monitor role describes which video stream will be shown on the monitor connected to the video output DVI-I connector.

**Requires user role:** ADMIN

**Value space:** <Auto/First/Second/PresentationOnly/Recorder>

*Auto:* The system will detect when a monitor is connected and assign a monitor role to it. The first monitor connected will be assigned monitor role First. In a multi-monitor setup the next monitors will be assigned monitor role Second.

*First/Second:* Define the role of the monitor in a multi-monitor setup. In a single-monitor setup, there is no difference between First and Second.

*PresentationOnly:* Show presentation video stream if active, and nothing else.

*Recorder:* Show all participants, including the local main video. If active, also show the presentation.

**Example:** Video Output DVI 2 MonitorRole: Auto

## Video Output DVI [2] OverscanLevel

Some TVs or other monitors may not display the whole image sent out on the systems video output, but cuts the outer parts of the image. In this case this setting can be used to let the system not use the outer parts of video resolution. Both the video and the OSD menu will be scaled in this case.

**Requires user role:** ADMIN

**Value space:** <Medium/High/None>

*Medium:* The system will not use the outer 3% of the output resolution.

*High:* The system will not use the outer 6% of the output resolution

*None:* The system will use all of the output resolution.

**Example:** Video Output DVI 2 OverscanLevel: None

## Video Output DVI [2] Resolution

Select the preferred resolution for the monitor connected to the video output DVI-I connector. This will force the resolution on the monitor.

**Requires user role:** ADMIN

**Value space:** <Auto/640\_480\_60/800\_600\_60/1024\_768\_60/1280\_1024\_60/1280\_720\_50/1280\_720\_60/1920\_1080\_50/1920\_1080\_60/1280\_768\_60/1360\_768\_60/1366\_768\_60/1600\_1200\_60/1680\_1050\_60/1920\_1200\_60>

*Auto:* The system will automatically try to set the optimal resolution based on negotiation with the connected monitor.

*Range:* 640x480@60p, 800x600@60p, 1024x768@60p, 1280x1024@60p, 1280x720@50p, 1280x720@60p, 1920x1080@50p, 1920x1080@60p, 1280x768@60p, 1360x768@60p, 1366x768@60p, 1600x1200@60p, 1680x1050@60p, 1920x1200@60p

**Example:** Video Output DVI 2 Resolution: Auto

### Video Output Composite [3] MonitorRole

NOTE: This command is not supported on Codec C40.

The Composite monitor role describes which video stream will be shown on the monitor connected to the video output Composite connector.

**Requires user role:** ADMIN

**Value space:** <Auto/First/Second/PresentationOnly/Recorder>

*Auto:* The system will detect when a monitor is connected and assign a monitor role to it. The first monitor connected will be assigned monitor role First. In a multi-monitor setup the next monitors will be assigned monitor role Second.

*First/Second:* Define the role of the monitor in a multi-monitor setup. In a single-monitor setup, there is no difference between First and Second.

*PresentationOnly:* Show presentation video stream if active, and nothing else.

*Recorder:* Show all participants, including the local main video. If active, also show the presentation.

**Example:** Video Output Composite 3 MonitorRole: Auto

### Video Output Composite [3] OverscanLevel

NOTE: This command is not supported on Codec C40.

Some TVs or other monitors may not display the whole image sent out on the systems video output, but cuts the outer parts of the image. In this case this setting can be used to let the system not use the outer parts of video resolution. Both the video and the OSD menu will be scaled in this case.

**Requires user role:** ADMIN

**Value space:** <Medium/High/None>

*Medium:* The system will not use the outer 3% of the output resolution.

*High:* The system will not use the outer 6% of the output resolution

*None:* The system will use all of the output resolution.

**Example:** Video Output Composite 3 OverscanLevel: None

### Video Output Composite [3] Resolution

NOTE: This command is not supported on Codec C40.

Select the preferred resolution for the monitor connected to the video output Composite connector. This will force the resolution on the monitor.

**Requires user role:** ADMIN

**Value space:** <PAL/NTSC>

*Range:* PAL, NTSC

**Example:** Video Output Composite 3 Resolution: NTSC

### Video Wallpaper

Select a background image (wallpaper) for the video screen when idle.

**Requires user role:** USER

**Value space:** <None/Custom/Growing/Summersky/Waves>

*None:* There is no background image on the screen, i.e. the background is black.

*Custom:* Use the custom wallpaper that is stored on the system as background image on the screen. As default, there is no custom wallpaper stored and the background will be black. You can upload a custom wallpaper to the system using the web interface. The maximum supported resolution is 1920x1200.

*Summersky, Growing, Waves:* The chosen background image is shown on the screen.

**Example:** Video Wallpaper: Summersky



## Experimental settings

The Experimental settings are for testing only and should not be used unless agreed with Cisco. These settings are not documented and WILL change in later releases.

## Chapter 4

# Setting passwords

## Setting the system password

You need to sign in to be able to use the web and command line interfaces of your system.

The video system is delivered with a default user account with full credentials. The user name is *admin*, and initially, no password is set for the default user.

A warning, saying that the system password is not set, is shown on screen until a password is set for the *admin* user.



**We strongly recommend that you set a password for the admin user, and to any other user with similar credentials, to restrict access to system configuration.**

Make sure to keep a copy of the password in a safe place. You have to factory reset the unit if you have forgotten the password.

### Other user accounts

You can create as many user accounts as you like for your video system.

You can read more about how to create and manage user accounts in the ► [User administration](#) section.

### Changing your own system password

Perform the following steps to change the system password.

If a password is currently not set, use a blank *Current password*; to remove a password, leave the *New password* fields blank.

1. Sign in to the web interface with your user name and current password.
2. Click your user name in the upper right corner and choose *Change password* in the drop down menu.
3. Enter the *Current password*, the *New password*, and repeat the new password in the appropriate input fields.

The password format is a string with 0–64 characters.

4. Click *Change password*.

### Changing another user’s system password

If you have administrator access rights, you can change all users’ passwords by performing the following steps:

1. Sign in to the web interface with your user name and password.
2. Go to the *Maintenance* tab and select *User Administration*.
3. Choose the appropriate user from the list.
4. Enter a new password and PIN code.
5. Click *Save*.

## Setting the menu password

When starting up the video conference system for the first time anyone can access the Administrator Settings menu with either the remote control or the Touch controller because the menu password is not set.



**We strongly recommend that you set a menu password, because the administrator settings may severely affect the behavior of the system.**

You should use the web interface or remote control to set the menu password; the Touch controller cannot be used.

### Setting the menu password from the web interface

1. Sign in to the web interface with your user name and current password.
2. Go to [Configuration > System Configuration](#).
3. Click [Set/Change Administrator Settings menu password](#) to open the menu password dialog.
4. Enter the password in the input field.
5. Click [Save](#) to set/change the password.



To find the system's IP address tap [Settings \(✖\)](#) > [System Information](#) on the Touch controller, or navigate to [Home > Settings > System Information](#) using the remote control and on-screen menu.

### Setting the menu password using the remote control

1. In the on screen menu, go to [Home > Settings > Administrator settings > Set menu password](#).  
The password format is a string with 0-255 characters.  
To deactivate the password leave the password input field empty.
2. Enter the menu password in the input field. The password you enter is hidden; each character is replaced with a star (\*).  
On the remote control, press the # key to toggle between lower or upper case characters and numbers: abc/ABC/123.
3. Select [Save](#) to save the changes, or [Cancel](#) to leave without saving.
4. Press [Home \(🏠\)](#) to exit.

## Setting a root password

You can protect the file system of your video system by setting a password for the root user.

The root user is disabled by default. You have to use the command line interface to enable the root user and set a root password.

### Activate the root user and set the password

Perform the following steps to activate the root user and set a password for it:

1. Connect to the system through the network or the system's serial data port (if available) and open a command line interface (SSH or Telnet).
2. Sign in to the system with user name and password. The user needs ADMIN rights.
3. Type the following command:  

```
systemtools rootsettings on <password>
```



The root password is not the same as the system (admin) password.



# Appendices

## Cisco VCS provisioning

When using Cisco VCS (Video Communication Server) provisioning, a template containing all the settings that can be provisioned must be uploaded to Cisco TMS (TelePresence Management System). This is called the *Cisco TMS provisioning configuration template*.

All the system settings for your video system are included in this template. All settings except *SystemUnit Name* and *SIP Profile [1..1] URI* can be automatically provisioned to the video system.

The settings are described in the ► [System settings](#) chapter in this guide. Examples showing either the default value or an example value are included.

### Downloading the provisioning configuration template

You can download the templates for the Profile series here:

► [http://www.cisco.com/en/US/products/ps11326/prod\\_release\\_notes\\_list.html](http://www.cisco.com/en/US/products/ps11326/prod_release_notes_list.html)

You can download the templates for the C series here:

► [http://www.cisco.com/en/US/products/ps11422/prod\\_release\\_notes\\_list.html](http://www.cisco.com/en/US/products/ps11422/prod_release_notes_list.html)

For each software release there is one provisioning configuration template for every video system model. Take care to download the correct file.

Read the *Cisco TMS Provisioning Deployment Guide* to find how to upload the file to Cisco TMS, and how to set the desired values for the parameters to be provisioned. If not set by Cisco TMS, the default values will be used.

## About monitors when you have a Codec C60

### Connecting the main monitor

The main monitor can be connected to video output HDMI 1 (the default connector for the main monitor) or DVI-I 2.

The codec will read the native resolution of the monitor and output this if possible. Typically this will give the best possible picture for the connected monitor. If auto fails, you will have to select the resolution manually using the [Video > Output > HDMI 1 > Resolution](#) and [Video > Output > DVI 2 > Resolution](#) settings.

### Connecting to HDMI 1

When connecting the main monitor to HDMI 1 the menu, icons and other information on screen (OSD - on screen display) will be displayed on the monitor automatically. This is because HDMI 1 is the default video output of the codec.

### Connecting to DVI-I 2

When connecting the main monitor to the DVI-I 2 output, the menus, icons and other information are not automatically displayed on screen. You must move the OSD to the chosen output.

The video outputs of Codec C60

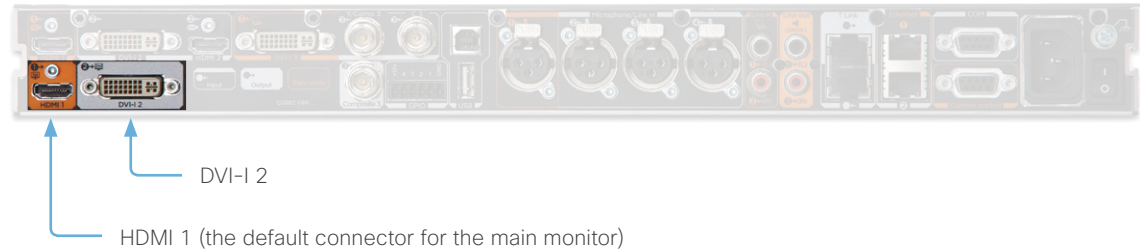

### Moving the OSD

You can move the OSD using the remote control or the web interface.

#### Remote control

Check which connector the main monitor is connected to, and run the following key sequence on the remote control.

- `Disconnect * # * # 0 x #` x=1 (HDMI 1) x=2 (DVI-I 2)

Example: Setting DVI-I 2 as the OSD output.

- \* - # - \* - # - 0 - 2 - #

#### Web interface

Open the System Configuration page. Go to [Video > OSD > Output](#) and choose the video output connector for the main monitor.

### Dual monitors

When you want to run a dual monitor setup, connect the main monitor to video output HDMI 1 and the second monitor to video output DVI-I 2 on the codec.

#### Dual monitor configuration

To distribute the layout on the two monitors, go to Advanced configuration (menu on screen) or open the System Configuration page (web interface). Then go to [Video > Monitors](#) and choose **Dual**.

## About monitors when you have a Codec C40

### Connecting the main monitor

The main monitor can be connected to video output HDMI 1 (the default connector for the main monitor) or DVI-I 2.

The codec will read the native resolution of the monitor and output this if possible. Typically this will give the best possible picture for the connected monitor. If auto fails, you will have to select the resolution manually using the [Video > Output > HDMI 1 > Resolution](#) and [Video > Output > DVI 2 > Resolution](#) settings.

### Connecting to HDMI 1

When connecting the main monitor to HDMI 1 the menu, icons and other information on screen (OSD - on screen display) will be displayed on the monitor automatically. This is because HDMI 1 is the default video output of the codec.

### Connecting to DVI-I 2

When connecting the main monitor to the DVI-I 2 output, the menus, icons and other information are not automatically displayed on screen. You must move the OSD to the chosen output.

The video outputs of Codec C40



### Moving the OSD

You can move the OSD using the remote control or the web interface.

#### Remote control

Check which connector the main monitor is connected to, and run the following key sequence on the remote control.

- `Disconnect * # * # 0 x #` x=1 (HDMI 1) x=2 (DVI-I 2)

Example: Setting DVI-I 2 as the OSD output.

- \* - # - \* - # - 0 - 2 - #

#### Web interface

Open the System Configuration page. Go to [Video > OSD > Output](#) and choose the video output connector for the main monitor.

### Dual monitors

When you want to run a dual monitor setup, connect the main monitor to video output HDMI 1 and the second monitor to video output DVI-I 2 on the codec.

#### Dual monitor configuration

To distribute the layout on the two monitors, go to Advanced configuration (menu on screen) or open the System Configuration page (web interface). Then go to [Video > Monitors](#) and choose **Dual**.

## Connecting the Cisco TelePresence Touch 8" controller

The Cisco TelePresence Touch 8" controller is an alternative to the remote control and on screen menus.

When a Touch controller is connected to the codec, the remote control cannot be used. You have to disconnect (unpair) the Touch controller in order to use the remote control.

Touch 8" can be used with a C Series codec running software version TC4.1 or later.

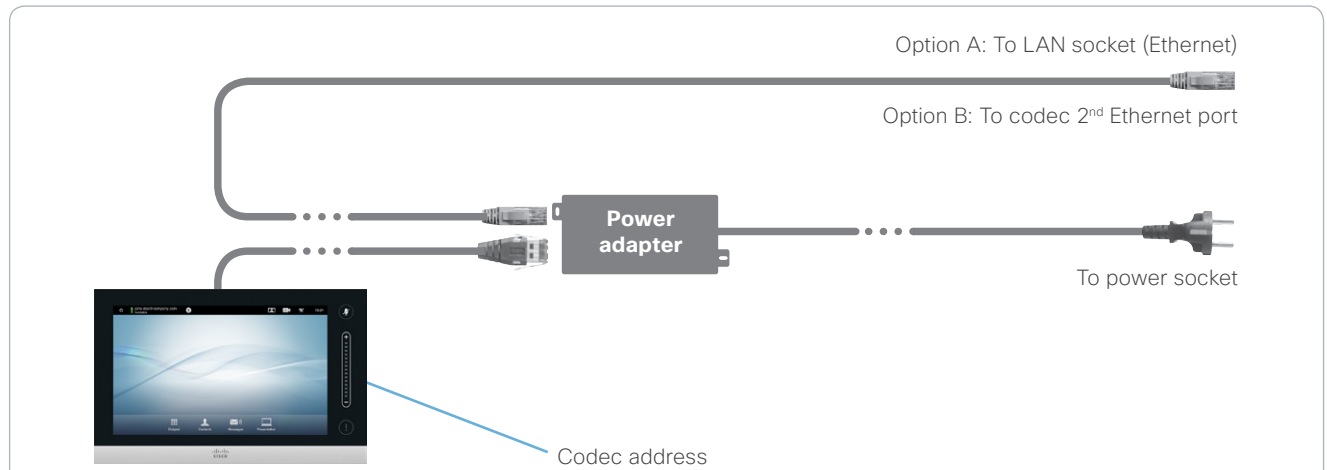

### Connecting the Touch controller

There are two options how to connect the Touch controller to the codec. In both cases the connection is via the provided power adapter, as illustrated above.

#### A. Connecting the Touch controller to the codec via LAN.

To enable this mode of operation make sure that the [NetworkServices > SSH > Mode\\*](#) setting is turned **On**.

The process of associating the Touch controller to the codec is called pairing. The codec is signalling that it is available for pairing for 30 minutes after it is switched on.

We recommend that the Touch controller and video system is kept on the same subnet.

#### B. Connecting the Touch controller directly to the codec's second Ethernet port.

To enable this mode of operation use the remote control and navigate to [Home > Settings > Administrator settings > Pairing > Direct pairing](#) and choose **On**.

Alternatively, set the [NetworkPort 2 > Mode\\*](#) setting to **DirectPairing**.

Restart the codec for the change to take effect.

### Touch controller set-up

Once the Touch controller is connected to power, the set-up procedure begins. Follow the instructions on screen.

If you have connected the unit to the codec via LAN, you have to choose which codec to pair with. If the codec is not in the list of available codecs displayed on the Touch controller, you can choose a codec manually by entering its IP address.

If the Touch controller needs software upgrade, new software will be downloaded from the codec and installed on the unit automatically as part of the set-up procedure. The Touch controller restarts after the upgrade.

You can verify that the Touch controller is successfully paired to the codec by checking that the codec address is displayed in the top banner.

If you want more details on Touch installation, please read the [Cisco TelePresence Touch 8 inch Installation Guide](#), which is available on the Cisco web site.

\* You will find this setting in the Advanced Configuration on-screen menu (remote control) or in the System Configuration page on the web interface.

## Advanced customization of video and audio

The codec supports full customization of the audio routing and video layouts/templates allowing support for advanced meeting room setups and integrations.

The TC Console application, which is a free software tool that runs on PC/Mac, provides a graphical interface to the advanced customizable features of the codec. TC Console includes the following modules:

### Video compositor

- Modify the default video compositing behavior of the codec
- Add new layouts
- Change the automatically chosen layout
- Control what video sources are shown where and when

### Audio console

- Configure the audio system of the codec.
- Change the default mixing, routing and equalizers
- Set various input and output connector properties

### GPIO

- Change the behavior of the GPIO, i.e. what the codec should do when pins go high/low

For more details about the functionality, see the user guide included in the TC Console application itself or download the TC Console user guide from <http://www.cisco.com/go/cseries-docs>

### How to obtain the TC Console application

Download the TC Console application for free from the Cisco Developer Network (CDN) web site. Go to:

► <http://developer.cisco.com/web/telepresence-developer>



Video compositor

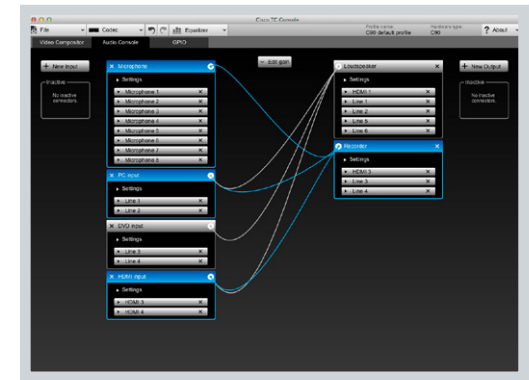

Audio console

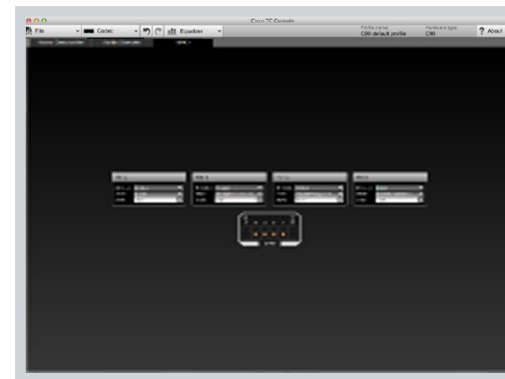

GPIO

## Optimal definition profiles

Under ideal lighting conditions the bandwidth (call rate) requirements can be substantially reduced.

The optimal definition profile should reflect the lighting conditions in your room and the quality of the video input (camera); the better the lighting conditions and video input, the higher the profile. Then, in good lighting conditions, the video encoder will provide better quality (higher resolution or frame rate) for a given call rate.

In general, we recommend the optimal definition profile set to Normal. However, if lighting conditions are good we recommend that you test the endpoint on the various Optimal Definition Profile settings before deciding on a profile.

Go to System Configuration on the web interface and navigate to [Video > Input > Source \[1..n\] > OptimalDefinition > Profile](#) to choose the preferred optimal definition profile.

You can set a resolution threshold to determine when to allow sending video at 60 fps. For all resolutions lower than this threshold, the maximum transmitted frame rate will be 30 fps; for higher resolutions, 60 fps will be possible if the available bandwidth is adequate.

Go to System Configuration on the web interface and navigate to [Video > Input > Source \[1..n\] > OptimalDefinition > Threshold60fps](#) to set the threshold.

The video input quality settings must be set to Motion for the optimal definition settings to take any effect. With the video input quality set to Sharpness, the endpoint will transmit the highest resolution possible, regardless of frame rate.

Go to System Configuration on the web interface and navigate to [Video > Input > Source \[1..n\] > Quality](#) to set the video quality parameter to Motion.

You can read more about the video settings in the [System settings](#) chapter.



### High

Typically used in dedicated video conferencing rooms. Requires very good lighting conditions and a good quality video input to achieve a good overall experience.

Under ideal conditions the bandwidth requirements can be reduced by up to 50% compared to Normal.



### Medium

Typically used in rooms with good and stable lighting conditions and a good quality video input.

The bandwidth requirements can be reduced by up to 25% compared to Normal.



### Normal

This setting is typically used in office environments where the room is normally to poorly lit.

Typical resolutions used for different optimal definition profiles, call rates and frame rates

Frame rate	Optimal Definition Profile	Call rate						
		256 kbps	768 kbps	1152 kbps	1472 kbps	2560 kbps	4 Mbps	6 Mbps
30 fps	Normal	512×288	1024×576	1280×720	1280×720	1920×1080	1920×1080	1920×1080
	Medium	640×360	1280×720	1280×720	1280×720	1920×1080	1920×1080	1920×1080
	High	768×448	1280×720	1280×720	1920×1080	1920×1080	1920×1080	1920×1080
60 fps	Normal	256×144	512×288	768×448	1024×576	1280×720	1280×720	1280×720*
	Medium	256×144	768×448	1024×576	1024×576	1280×720	1280×720*	1280×720*
	High	512×288	1024×576	1280×720	1280×720	1280×720*	1280×720*	1280×720*

\* The resolution will be 1920×1080 for 1080p60 capable C60 codecs (main board rev F and later).

## ClearPath – Packet loss resilience

ClearPath introduces advanced packet loss resilience mechanisms that increase the experienced quality when you use your video system in an error prone environment.

We recommend that you keep ClearPath enabled on your video system.

Go to Advanced configuration (menu on screen) or open the System Configuration page (web interface):

- Navigate to [Conference 1 > PacketLossResilience > Mode](#)

Choose **Off** to disable ClearPath and **On** to enable ClearPath.



## Requirement for speaker systems connected to a Cisco TelePresence C Series codec

Cisco has put in a lot of effort to minimize the camera to screen delay on our TelePresence endpoints.

New consumer TVs are usually equipped with “Motion Flow” or similar technology to insert new video frames between standard frames to create smoother images. This processing takes time and to maintain lip synchronization, the TV will delay the audio so that the audio and video arrives at the same time.

The echo canceller in the Cisco endpoints can handle such delay up to 30ms. Many consumer TVs are not made for real time video communication and may introduce more than 30ms of delay.

If you use such a TV together with a C Series codec it is recommended that you turn off “Motion Flow”, “Natural Motion” or any other video processing that introduces additional delay.

Some consumer TVs also support advanced audio processing like “Virtual Surround” effects and “Dynamic Compression” to improve the TV experience. Such processing will make any acoustic echo canceller malfunction and should hence be switched off.

Some monitors are equipped with a setting called ‘Game Mode’. This mode is specifically designed to help reduce the response time and will usually help to reduce the delay.

## DNAM for Profile 42"/52"/55"

The DNAM (Digital Natural Audio Module) is built on two specially designed and separate modules: the amplifier and the loudspeaker cabinet.

### The DNAM loudspeaker

#### 3-way center loudspeaker system

- Frequency range 50Hz - 20kHz
- 2 x 100mm low- and midrange loudspeaker 8ohm nominal, excellent quality (SEAS Prestige series)
- 1 x 25mm dome tweeter, 6ohm nominal, excellent quality
- Digitally filtered audio signals received from DNAM amplifier
- Long time max power 70 watt on all loudspeakers
- Enclosed MDF loudspeaker cabinet

#### Integrated stereo loudspeaker

Each side has:

- 1 x 90mm fullrange loudspeaker, 8ohm nominal, excellent quality
- Frequency range 70Hz - 20kHz
- Enclosed MDF loudspeaker cabinet

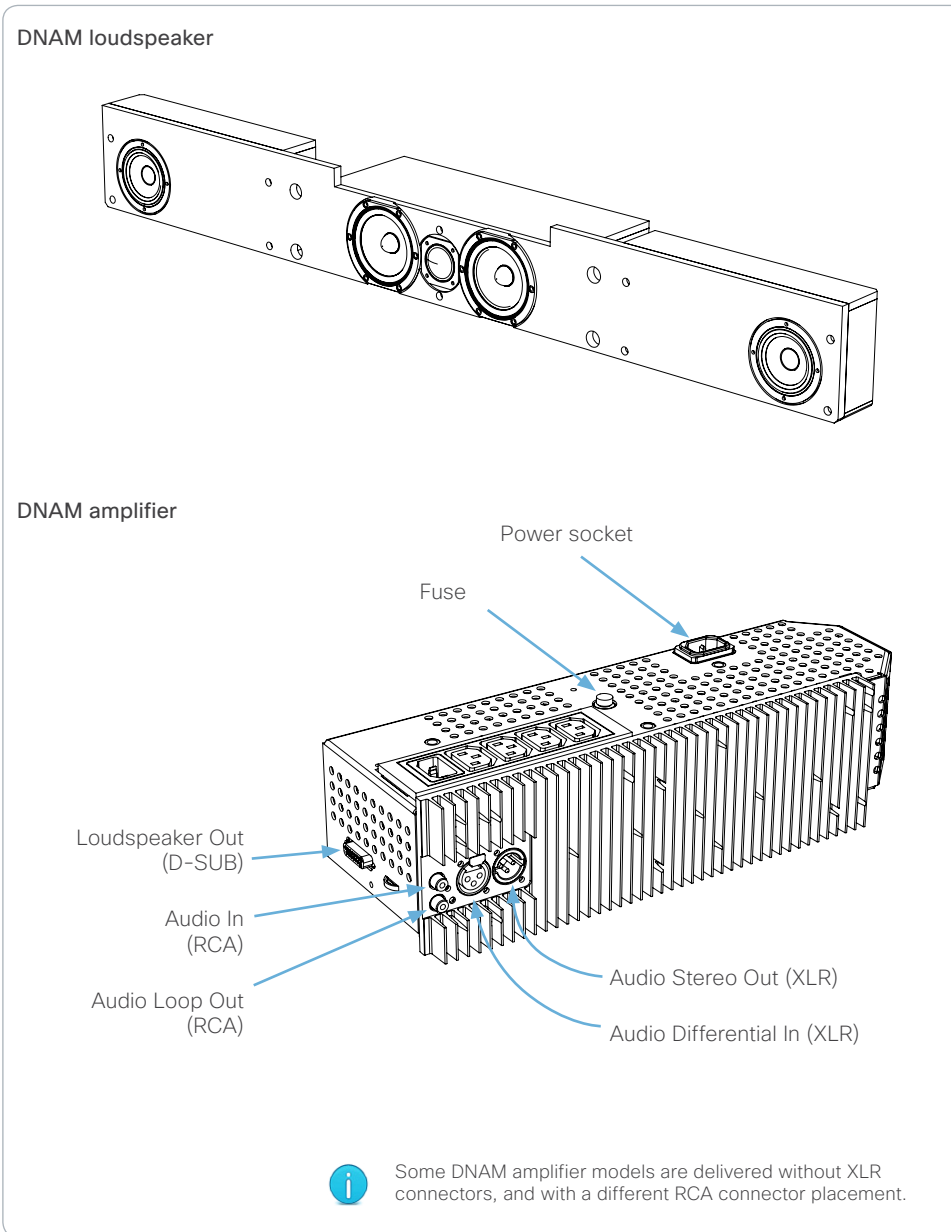

### The DNAM amplifier

- 5 x 50watt continuous average output power
- Full frequency range for audio (20Hz - 20kHz)
- Digital signal processing and filtering on all channels for best audio detail clarity
- Digital crossover filtering on center channels
- In/out:

*Audio In:* SPDIF (stereo) or Analog (mono) using the same connector

*Audio Loop Out:* line out directly from the input; always analog even with SPDIF in

*Audio Differential In:* female XLR, pinout: 1 - GND, 2 - Signal (+), 3 - Signal (-)

*Audio Stereo Out:* male XLR, common GND configuration

*Loudspeaker Out:* female D-SUB 15-pin

- Fuse 2A 250V slow, 5 x 20mm, Littelfuse type 215002.



Always use this type of fuse. Using a different type may lead to serious hardware malfunction.

### Spare fuses

The Profile system is delivered with two spare DNAM fuses in the column.

Take care not to damage the fuse and fuse holder when replacing a fuse.

- Push the fuse holder slightly inwards and turn counter-clockwise to release the fuse.
- When reinserting the fuse and fuse holder, push slightly inwards and turn the holder carefully clockwise until it locks in place.

## DNAM for Profile 65”

The DNAM (Digital Natural Audio Module) is built on two specially designed and separate modules: the amplifier and the loudspeaker cabinet.

### The DNAM loudspeaker

#### 3-way center loudspeaker system

- Frequency range 50Hz - 20kHz
- 2 x 100mm low- and midrange loudspeakers, 8 ohm nominal, reference quality (SEAS Excel series)
- 1 x 25mm dome tweeter, 6 ohm nominal, excellent quality
- Digitally filtered audio signals received from DNAM amplifier
- Long time max power 70 watt on all loudspeakers
- Enclosed MDF loudspeaker cabinet

#### 2-way integrated stereo loudspeaker

Each side has:

- 1 x 100mm low- and midrange loudspeaker, 8 ohm nominal, reference quality (SEAS Excel series)
- 1 x 25mm dome tweeter, 6 ohm nominal, excellent quality
- Passive crossover filter
- Frequency range 70Hz - 20kHz
- Long time max power 70 watt
- Enclosed MDF loudspeaker cabinet

DNAM loudspeaker

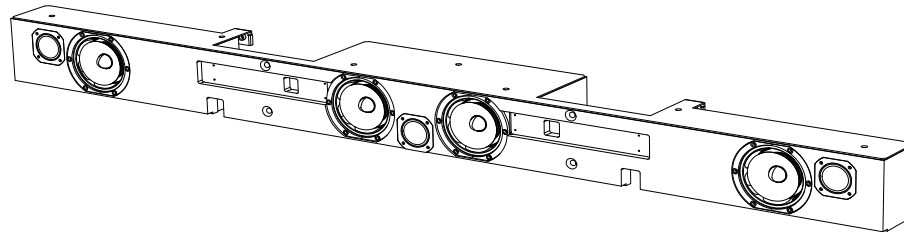

DNAM amplifier

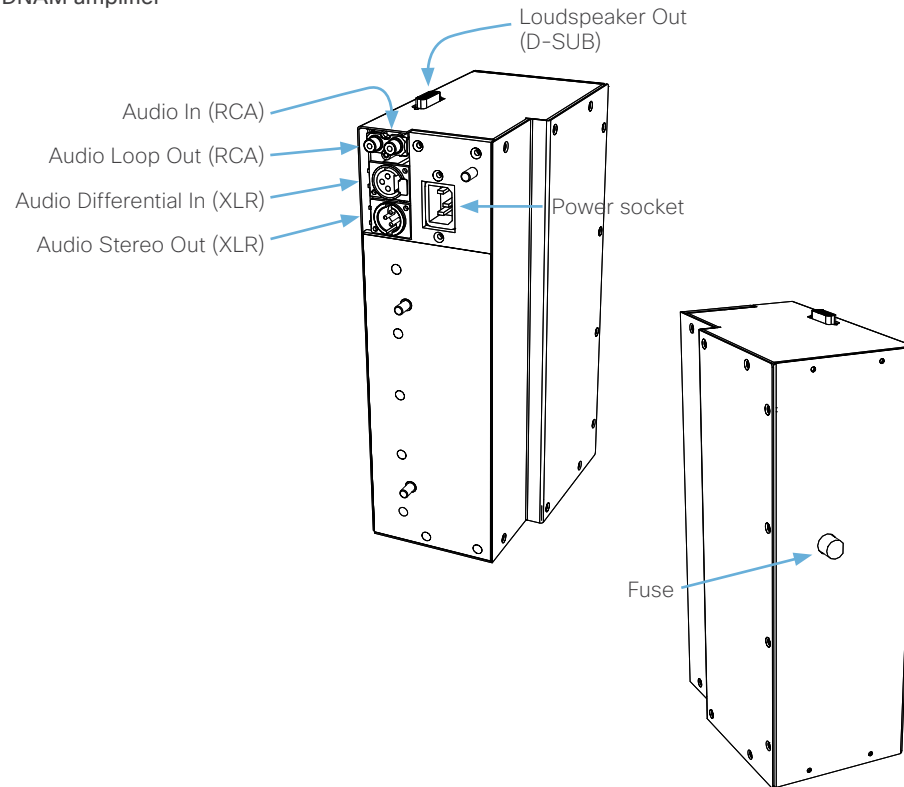

### The DNAM amplifier

- 5 x 50watt continuous average output power
- Full frequency range for audio (20Hz - 20kHz)
- Digital signal processing and filtering on all channels for best audio detail clarity
- Digital crossover filtering on center channels
- In/out:

*Audio In:* SPDIF (stereo) or Analog (mono) using the same connector

*Audio Loop Out:* line out directly from the input; always analog even with SPDIF in

*Audio Differential In:* female XLR, pinout: 1 - GND, 2 - Signal (+), 3 - Signal (-)

*Audio Stereo Out:* male XLR, common GND configuration

*Loudspeaker Out:* female D-SUB 15-pin

- Fuse 2A 250V slow, 5 x 20mm, Littelfuse type 215002



Always use this type of fuse. Using a different type may lead to serious hardware malfunction.

### Spare fuses

The Profile system is delivered with two spare DNAM fuses in the column.

Take care not to damage the fuse and fuse holder when replacing a fuse.

- Push the fuse holder slightly inwards and turn counter-clockwise to release the fuse.
- When reinserting the fuse and fuse holder, push slightly inwards and turn the holder carefully clockwise until it locks in place.

## Factory resetting



It is not possible to undo a factory reset.

You should always backup the log files and the current configuration before you factory reset a system. Open the web interface, sign in, and follow these steps:

- Navigate to [Maintenance > System Recovery](#) and choose the [Save Data](#) tab.
- Click [Download logs](#) and [Download Configuration Backup](#) and follow the instructions to save the files on your computer.

If there is a severe problem with the video system, resetting it to its default factory settings should be the last resort.

Always consider reverting to the previously used software version before performing a factory reset. In many situations this will recover the system. Note that both the current and the previous software images reside on the system. Read about software swapping in the [System recovery](#) section.

We recommend that you use either a Touch controller or the web interface to factory reset the system. If these interfaces are not available, you can connect to the system's standard serial interface and issue a factory reset command.

The remote control and on-screen menu do not give access to factory reset.

When factory resetting the video system the following happens:

- The call logs will be deleted.
- Passwords will be reset to default.
- All system parameters will be reset to default values.
- All files that have been uploaded to the system will be deleted. This includes, but is not limited to, custom backgrounds, certificates, and the favorites list (My contacts).
- The previous (inactive) software image will be deleted.
- Release keys and option keys will **not** be affected.

The system restarts automatically after the reset. It is using the same software image as before.

### Touch

1. Tap gently on the Touch screen if the unit is in sleep mode.
2. Navigate to [Settings \(✕\) > Administrator Settings > Reset](#).
3. Tap the [Factory Reset](#) button.

The system reverts to the default factory settings and restarts automatically. This will take a few minutes.

The system confirms the factory reset by displaying a notification on the main screen when up and running again. The notification disappears after approximately 10 seconds.

### Web



Tap [Settings \(✕\) > System Information](#) on the Touch controller, or navigate to [Home > Settings > System information](#) using the remote control, to find the system's IP address (IPv4 or IPv6).

1. Open a web browser and enter the IP address of the video system in the address bar.
2. Navigate to [Maintenance > System Recovery](#) and choose the [Factory Reset](#) tab.
3. Read the provided information carefully before you click [Perform a factory reset...](#)
4. Click the red [Yes](#) button to confirm that you want to perform a factory reset.

The system reverts to the default factory settings and restarts automatically. This will take a few minutes.

The system confirms the factory reset by displaying a notification on the main screen when up and running again. The notification disappears after approximately 10 seconds.

### Serial interface

You have to connect to the video system's COM port with a serial cable. The serial port is enabled as a default, but it may have been disabled.

The connection parameters for the COM port are as follows:

- Data bits: 8
- Parity: None
- Stop bits: 1
- Flow control: None
- Baud rate: The default value is 38400 bps, but it may have been changed

You can read more about the system's serial port settings in the [System settings](#) chapter.

1. Login as admin (administrator rights).
2. Issue the following command:

```
xCommand SystemUnit FactoryReset Confirm: Yes
```

You will see the following text:

```
*r FactoryResetResult:
**end
OK
```

The system will revert to the default factory settings and automatically restart. This will take a few minutes.

The system confirms the factory reset by displaying a notification on the main screen when up and running again. The notification disappears after approximately 10 seconds.

## Factory resetting the Touch 8” controller

You must use the New message indicator and Mute buttons to reset the Touch 8” controller to its default factory settings.

When factory resetting the Touch controller the logs will be cleared, and the configuration and pairing information are lost.

The Touch controller restarts after the reset and must receive a new configuration from the video system.

- If the Touch controller is directly connected to the video system it receives the configuration automatically.
- If it is connected via LAN it receives the new configuration as soon as it is successfully paired to the video system.



It is not possible to undo a factory reset.

### Touch

1. Locate the *New message indicator* and *Mute* buttons.

The *New message indicator* is a bit hard to see, but it is the button with the exclamation mark on it.

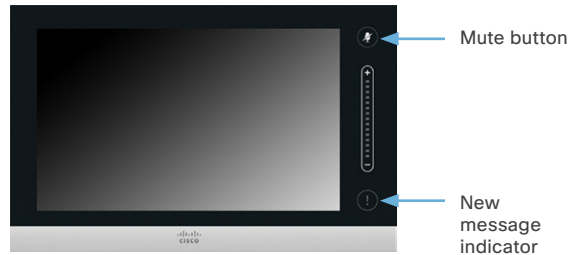

2. Press and hold the *New message indicator* until it lights up (approximately 10 seconds).

3. Press the *Mute* button twice.

The Touch controller automatically reverts to the default factory settings and restarts.

## Technical specifications

### Codec C60/C40

#### UNIT DELIVERED COMPLETE WITH:

- Video conferencing codec, wireless remote control, rack mounting rails (C60), rack mounting ears (C40), LAN cable, power cable

#### BANDWIDTH

- H.323/SIP up to 6 Mbps point-to-point

#### FIREWALL TRAVERSAL

- Cisco TelePresence Expressway technology
- H.460.18, H.460.19 firewall traversal
- SIP ICE (Interactive Connectivity Establishment)

#### VIDEO STANDARDS

- H.261
- H.263
- H.263+
- H.264
- H.264 SVC

#### VIDEO FEATURES

- Native 16:9 widescreen
- Advanced screen layouts
- Intelligent video management
- Local auto layout
- 7 embedded individual video compositors – 1 for every output and 1 for every encoder (C60 only) \*\*

#### VIDEO INPUTS (5 INPUTS (C60) / 4 INPUTS (C40))

##### Two HDMI inputs; supported formats:

- 1920 × 1080@60, 59.94 Hz (1080p60)
- 1920 × 1080@50 Hz (1080p50)
- 1920 × 1080@30, 29.97 Hz (1080p30)
- 1920 × 1080@25 Hz (1080p25)
- 1920 × 1080@24, 23.97 Hz (1080p24)
- 1280 × 720@60, 59.94 Hz (720p60)
- 1280 × 720@50 Hz (720p50)
- 720 × 480@60, 59.94 Hz (480p60)
- 640 × 480@60 Hz (480p60)
- 1600 × 1200@50, 60 Hz (UXGA)
- 1280 × 1024@60, 75 Hz (SXGA)
- 1024 × 768@60, 70, 75, 85 Hz (XGA)
- 800 × 600@56, 60, 72, 75, 85 Hz (SVGA)
- 1920 × 1200@50, 60 Hz (WUXGA)

- 1680 × 1050@60 Hz (WSXGA+)
- 1440 × 900@60 Hz (WXGA+)
- 1280 × 768@60 Hz (WXGA)

##### Two (C60), one (C40) × DVI-I inputs; supported formats:

###### Analog (VGA):

- 1920 × 1080@60 Hz (1080p60)
- 1280 × 720@60 Hz (720p60)
- 1600 × 1200@60 Hz (UXGA)
- 1280 × 1024@60, 75 Hz (SXGA)
- 1280 × 960@60 Hz
- 1024 × 768@60, 70, 75, 85 Hz (XGA)
- 1920 × 1200@50 Hz (WUXGA)
- 1680 × 1050@60 Hz (WSXGA+)
- 1440 × 900@60 Hz (WXGA+)
- 1280 × 800@60 Hz (WXGA)
- 1280 × 768@60 Hz (WXGA)

###### Analog (YPbPr):

- 1920 × 1080@60 Hz (1080p60)
- 1920 × 1080@50 Hz (1080p50)
- 1920 × 1080@30 Hz (1080p30)
- 1920 × 1080@25 Hz (1080p25)
- 1280 × 720@60 Hz (720p60)
- 1280 × 720@50 Hz (720p50)
- 1280 × 720@30 Hz (720p30)
- 720 × 576@50 Hz (576p50)
- 720 × 480@60 Hz (480p60)

###### Digital (DVI-D):

- Same as HDMI, ref. above.

##### One S-video/Composite input (BNC connector):

- PAL/NTSC

- Extended Display Identification Data (EDID)

#### VIDEO OUTPUTS (3 OUTPUTS (C60) / 2 OUTPUTS (C40))

##### One HDMI output, one DVI-I output; supported formats:

- 1920 × 1080@60 Hz (1080p60)
- 1280 × 720@60 Hz (720p60)
- 1600 × 1200@60 Hz (UXGA)
- 1280 × 1024@60 Hz (SXGA)
- 1024 × 768@60 Hz (XGA)

- 800 × 600@60 Hz (SVGA)
- 640 × 480@60 Hz (VGA)
- 1920 × 1200@60Hz (WUXGA)
- 1360 × 768@60 Hz
- 1366 × 768@60 Hz
- 1280 × 768@60 Hz (WXGA)

##### One composite output (BNC connector) (C60 only):

- PAL/NTSC
- VESA Monitor Power Management
- Extended Display Identification Data (EDID)

#### LIVE VIDEO RESOLUTIONS (ENCODE/DECODE)

- 176 × 144@30 fps (QCIF)
- 352 × 288@30 fps (CIF)
- 512 × 288@30 fps (w288p)
- 576 × 448@30 fps (448p)
- 768 × 448@30 fps (w448p)
- 704 × 576@30 fps (4CIF)
- 1024 × 576@30 fps (w576p)
- 1280 × 720@30 fps (720p30)
- 1920 × 1080@30 fps (1080p30)\*
- 640 × 480@30 fps (VGA)
- 800 × 600@30 fps (SVGA)
- 1024 × 768@30 fps (XGA)
- 1280 × 1024@30 fps (SXGA) (C60 only)
- 1280 × 768@30 fps (WXGA)
- 1440 × 900@30 fps (WXGA+)\* (C60 only)
- 1680 × 1050@30 fps (WSXGA+)\* (C60 only)
- 1600 × 1200@30 fps (UXGA)\* (C60 only)
- 1920 × 1200@25fps (WUXGA)\* (C60 only)
- 512 × 288@60 fps (w288p60)\*
- 768 × 448@60 fps (w448p60)\*
- 1024 × 576@60 fps (w576p60)\*
- 1280 × 720@60 fps (720p60)\*

- 720p30 from 768kbps
- 720p60 from 1152kbps\*
- 1080p30 from 1472 kbps\*

\* Requires option

\*\* Multiwindow compositing not supported on the dual stream

\*\*\* Not supported on 4 x zoom camera

#### AUDIO STANDARDS

- G.711
- G.722
- G.722.1
- G.729AB
- 64 kbps and 128 kbps AAC-LD, mono and stereo

#### AUDIO FEATURES

- CD quality 20 kHz mono and stereo
- Four (C60) / Two (C40) separate acoustic echo cancellers
- 4-port (C60) / 2-port (C40) audio mixer
- Automatic gain control (AGC)
- Automatic noise reduction
- Active lip synchronization

#### AUDIO INPUTS (7 INPUTS (C60), 5 INPUTS (C40))

- Four microphones (C60) / two microphones (C40), 48V phantom powered, XLR connector, each with separate echo cancellers and noise reduction; all microphones can be set for balanced line level
- Two RCA/Phono inputs, line level: Stereo PC input, configurable to two RCA/Phono inputs, line level: Mono auxiliary/DVD input
- One HDMI input, digital: stereo PC/DVD input

#### AUDIO OUTPUTS (3 OUTPUTS)

- Two RCA/Phono outputs, line level, stereo main audio, configurable to S/PDIF or two RCA/Phono outputs, line level, mono to recording device
- One HDMI output, digital, stereo main audio

#### DUAL STREAM

- H.239 (H.323) dual stream
- BFCP (SIP) dual stream
- Support for resolutions up to 1080p30/WUXGA (C60) / WXGAp30 (C40), independent of main stream resolution

**MULTIPOINT SUPPORT**

- Four-way embedded SIP/H.323 MultiPoint, reference MultiSite
- Cisco TelePresence Multiway support (requires Cisco TelePresence Video Communication Server [Cisco VCS] and Cisco TelePresence MCU)
- Ability to natively join multipoint conferences hosted on Cisco Telepresence Multipoint Switch (CTMS)

**MULTISITE FEATURES\***

(embeddeed multipoint)

- Four-way SIP/H.323 MultiSite. Resolution up to 720p30 (C60) / w576p30 (C40)
- Full individual audio and video transcoding
- Individual layouts in multisite continuous presence (takes out selfview)
- H.323/SIP/VoIP in the same conference
- Support for Presentation (H.239/BFCP) from any participant at resolutions up to WXGAp30 (C60) / WXGAp30 (C40)
- Best Impression (automatic continuous presence layouts)
- H.264, encryption, and dual stream from any site
- Dial in and dial out
- Additional telephone call (no license required)
- Conference rates up to 10 Mbps

**PROTOCOLS**

- H.323
- SIP
- ISDN (requires Cisco TelePresence ISDN Link)

**EMBEDDED ENCRYPTION**

- H.323/SIP point-to-point
- Standards-based: H.235 v3 and Advanced Encryption Standard (AES)
- Automatic key generation and exchange
- Supported in Dual Stream

**IP NETWORK FEATURES**

- DNS lookup for service configuration
- Differentiated Services (QoS)
- IP adaptive bandwidth management (including flow control)
- Auto gatekeeper discovery
- Dynamic playout and lip-sync buffering
- H.245 DTMF tones in H.323
- Date and time support via NTP
- Packet loss based downspeeding
- URI Dialing
- TCP/IP
- DHCP
- 802.1x Network authentication
- 802.1Q Virtual LAN
- 802.1p QoS and class of service
- ClearPath
- Medianet: Mediatrace and Metadata

**IPv6 NETWORK SUPPORT**

- Single call stack support for both H323 and SIP
- Dual-stack IPv4 and IPv6 for DHCP, SSH, HTTP, HTTPS, DNS, DiffServ
- Support for both static and autoconfiguration (stateless address autoconfiguration)

**CISCO UNIFIED COMMUNICATIONS MANAGER**

(requires Cisco UCM version 8.6 or later)

- Native registration with Cisco Unified Communications Manager
- Basic Cisco Unified Communications Manager provisioning
- Firmware upgrade from Cisco Unified Communications Manager
- Cisco Discovery Protocol and DHCP option 150 support
- Basic telephony features such as hold, resume, transfer, and corporate directory lookup

**SECURITY FEATURES**

- Management through HTTPS and SSH
- IP administration password
- Menu administration password
- Disable IP services
- Network settings protection

**NETWORK INTERFACES**

- One LAN/Ethernet (RJ-45) 10/100/1000 Mbit
- One LAN/Ethernet (RJ-45) interface to be used for the Cisco TelePresence Touch for C-series user interface device only

**OTHER INTERFACES**

- USB host for future usage (C60 only)
- USB device for future usage
- GPIO – General purpose input/output (C60 only)

**PRECISIONHD 1080P CAMERA**

- 1/3" CMOS
- 12 x zoom (C60)
- 12 x zoom / 4 x zoom (C40)
- +15°/-25° tilt, +/- 90° pan
- 43.5° vertical field of view
- 72° horizontal field of view
- Focus distance 0.3m-infinity
- 1920 x 1080 pixels progressive @ 60fps (12 x zoom version)
- 1920 x 1080 pixels progressive @ 30fps (4 x zoom version)
- Other formats supported (configurable through dip-switch):
  - 1920 x 1080@60 Hz (HDMI only)\*\*\*
  - 1920 x 1080@50 Hz (HDMI only)\*\*\*
  - 1920 x 1080@30 Hz
  - 1920 x 1080@25 Hz
  - 1280 x 720@60 Hz\*\*\*
  - 1280 x 720@50 Hz \*\*\*
  - 1280 x 720@30 Hz
  - 1280 x 720@25 Hz
- Automatic or manual focus/brightness/white balance
- Far-end camera control
- Daisy-chain support (Visca protocol camera)\*\*\*
- Dual HDMI and HD-SDI outputs
- Upside-down mounting with automatic flipping of picture

**SYSTEM MANAGEMENT**

- Support for the Cisco TelePresence Management Suite (Cisco TMS)
- Total management through embedded SNMP, Telnet, SSH, XML, SOAP
- Remote software upload through web server, SCP, HTTP, HTTPS
- One RS-232 for local control and diagnostics
- Remote control and on-screen menu system

**DIRECTORY SERVICES**

- Support for local directories (My Contacts)
- Corporate directory
- Unlimited entries using server directory supporting LDAP and H.350 (requires Cisco TMS)
- Unlimited number for corporate directory (through Cisco TMS)
- Received calls with date and time
- Placed calls with date and time
- Missed calls with date and time

**POWER**

- Auto-sensing power supply
- 100-120/200-240 VAC, 60/50 Hz
- 175 watts max for codec and main camera

**OPERATING TEMPERATURE AND HUMIDITY**

- 0° C to 35° C (32° F to 95° F) ambient temperature
- 10% to 90% relative humidity (RH)

**STORAGE AND TRANSPORT TEMPERATURE**

- -20° C to 60° C (-4° F to 140° F) at RH 10-90% (non-condensing)

**DIMENSIONS**

- Length: 17.4 in. / 44.2 cm
- Height: 1.7 in. / 4.4 cm
- Depth: 10.9 in. / 27.8 cm
- Weight: 8.8 lbs / 4 kg

\* Requires option

\*\* Multiwindow compositing not supported on the dual stream

\*\*\* Not supported on 4 x zoom camera

**APPROVALS****EU/EEC**

- Directive 2006/95/EC (Low Voltage Directive)
  - Standard EN60950-1
- Directive 2004/108/EC (EMC Directive)
  - Standard EN55022, Class A
  - Standard EN55024
  - Standard EN61000-3-2/-3-3
- Directive 2011/65/EU (RoHS)

Warning: This is a class A product. In a domestic environment this product may cause radio interference in which case the user may be required to take adequate measures.

**USA**

- Approved according to UL60950-1
- Complies with FCC15B Class A

Note: This equipment has been tested and found to comply with the limits for a Class A digital device, pursuant to part 15 of the FCC Rules. These limits are designed to provide reasonable protection against harmful interference when the equipment is operated in a commercial environment. This equipment generates, uses, and can radiate radio frequency energy and, if not installed and used in accordance with the instruction manual, may cause harmful interference to radio communications. Operation of this equipment in a residential area is likely to cause harmful interference in which case the user will be required to correct the interference at his own expense.

**Canada**

- Approved according to CAN/CSA C22.2 No. 60950-1
- This Class A digital apparatus complies with Canadian ICES-003
- Cet appareil numérique de la classe A est conforme à la norme NMB-003 du Canada

**MTBF PRODUCT RELIABILITY/MTBF**

The predicted reliability is expressed in the expected random Mean Time Between Failures (MTBF) for the electronic components based on the Power On Hours:

Power On Hours (POH) > 69 000 hours

Useful Life Cycle > 6 years

ISO 9001 certificate is available upon request

All specifications are subject to change without notice, system specifics may vary.

All images in these materials are for representational purposes only, actual products may differ.

Cisco and the Cisco Logo are trademarks of Cisco Systems, Inc. and/or its affiliates in the U.S. and other countries. A listing of Cisco's trademarks can be found at [www.cisco.com/go/trademarks](http://www.cisco.com/go/trademarks). Third party trademarks mentioned are the property of their respective owners. The use of the word partner does not imply a partnership relationship between Cisco and any other company.

June 2013



## Profile 52"/55" using C60

### UNIT DELIVERED COMPLETE WITH:

- Full HD LCD display, Codec C60, Touch 8" user interface device, remote control, PrecisionHD Camera (1080p), microphone (3x with single screen, 4x with dual screen), Digital Audio Module, integrated speakers and integrated cabling.
- Choice of installation configuration: floor stand, wheel base or wall mount on pedestal.
- Choice of screen size and configuration.

### MONITOR available with:

- 52"/55" Full HD LCD, 16:9, 1080 × 1920 resolution

### BASE available with:

- Floor standing foot plate
- Wheel base (not available on 52" Dual / 55" Dual)
- Wall mount on pedestal

### BANDWIDTH

The same as Codec C60

### FIREWALL TRAVERSAL

The same as Codec C60

### VIDEO STANDARDS

The same as Codec C60

### VIDEO FEATURES

The same as Codec C60

### VIDEO INPUTS (5 INPUTS)

The same as Codec C60

### VIDEO OUTPUTS (3 OUTPUTS)

The same as Codec C60

### LIVE VIDEO RESOLUTIONS (ENCODE/DECODE)

The same as Codec C60

### AUDIO STANDARDS

The same as Codec C60

### AUDIO FEATURES

The same as Codec C60

### AUDIO INPUTS (7 INPUTS)

The same as Codec C60

### AUDIO OUTPUTS (3 OUTPUTS)

The same as Codec C60

### DUAL STREAM

The same as Codec C60

### MULTIPOINT SUPPORT

The same as Codec C60

### MULTISITE FEATURES\*

The same as Codec C60

### PROTOCOLS

The same as Codec C60

### EMBEDDED ENCRYPTION

The same as Codec C60

### IP NETWORK FEATURES

The same as Codec C60

### IPV6 NETWORK SUPPORT

The same as Codec C60

### CISCO UNIFIED COMMUNICATIONS MANAGER

The same as Codec C60

### SECURITY FEATURES

The same as Codec C60

### NETWORK INTERFACES

The same as Codec C60

### OTHER INTERFACES

The same as Codec C60

### PRECISIONHD 1080P CAMERA

The same as Codec C60

### SYSTEM MANAGEMENT

- The same as Codec C60, as well as
- Cisco TelePresence Touch 8" user interface device

### DIRECTORY SERVICES

The same as Codec C60

### POWER

#### Profile 52" / 52" Dual

- Auto-sensing power supply
- 100-120/200-240 VAC, 60/50Hz, 6 A max
- 175W max for codec and main camera
- Maximum power rating complete system, 526 W (52") / 870 W (52" Dual)

#### Profile 55" / 55" Dual

- Auto-sensing power supply
- 100-120/200-240 VAC, 60/50Hz, 4.5 A max (55") / 8 A (55" Dual)
- 175W max for codec and main camera
- Maximum power rating complete system, 350 W (55") / 550 W (55" Dual)
- The display complies with ENERGY STAR requirements

### OPERATING TEMPERATURE AND HUMIDITY

- 0° C to 35° C (32° F to 95° F) ambient temperature
- 10% to 90% relative humidity (RH)

### STORAGE AND TRANSPORT TEMPERATURE

- -20° C to 60° C (-4° F to 140° F) at RH 10-90% (non-condensing)

### DIMENSIONS

#### Profile 52"

- Height: 63.78in. / 162cm
- Width: 47.25in. / 120cm
- Depth: 6.7in. / 17cm (without footplate)
- Weight: 253.5lbs / 115kg (with floor standing footplate)
- 229.3lbs / 104kg (with wheel base)

#### Profile 52" Dual

- Height: 63.8in. / 162cm
- Width: 94.5in. / 240cm
- Depth: 6.7in. / 17cm (without footplate)
- Weight: 515.9lbs / 234kg (with floor standing footplate)

#### Profile 55"

- Height: 64.6in. / 164cm
- Width: 49.6in. / 126cm
- Depth: 6.7in. / 17cm (without footplate)
- Weight: 245lbs / 111kg (with floor standing footplate)
- 225lbs / 102kg (with wheel base)

#### Profile 55" Dual

- Height: 64.6in. / 164cm
- Width: 99.2in. / 252cm
- Depth: 6.7in. / 17cm (without footplate)
- Weight: 443lbs / 201kg (with floor standing footplate)

\* Requires option

**APPROVALS****EU/EEC**

- Directive 2006/95/EC (Low Voltage Directive)
  - Standard EN60950-1
- Directive 2004/108/EC (EMC Directive)
  - Standard EN55022, Class A
  - Standard EN55024
  - Standard EN61000-3-2/-3-3
- Directive 2011/65/EU (RoHS)

Warning: This is a class A product. In a domestic environment this product may cause radio interference in which case the user may be required to take adequate measures.

**USA**

- Approved according to UL60950-1
- Complies with FCC15B Class A

Note: This equipment has been tested and found to comply with the limits for a Class A digital device, pursuant to part 15 of the FCC Rules. These limits are designed to provide reasonable protection against harmful interference when the equipment is operated in a commercial environment. This equipment generates, uses, and can radiate radio frequency energy and, if not installed and used in accordance with the instruction manual, may cause harmful interference to radio communications. Operation of this equipment in a residential area is likely to cause harmful interference in which case the user will be required to correct the interference at his own expense.

**Canada**

- Approved according to CAN/CSA C22.2 No. 60950-1
- This Class A digital apparatus complies with Canadian ICES-003
- Cet appareil numérique de la classe A est conforme à la norme NMB-003 du Canada

**MTBF PRODUCT RELIABILITY/MTBF**

The predicted reliability is expressed in the expected random Mean Time Between Failures (MTBF) for the electronic components based on the Power On Hours:

Power On Hours (POH) > 69 000 hours

Useful Life Cycle > 6 years

ISO 9001 certificate is available upon request

All specifications are subject to change without notice, system specifics may vary.

All images in these materials are for representational purposes only, actual products may differ.

Cisco and the Cisco Logo are trademarks of Cisco Systems, Inc. and/or its affiliates in the U.S. and other countries. A listing of Cisco's trademarks can be found at [www.cisco.com/go/trademarks](http://www.cisco.com/go/trademarks). Third party trademarks mentioned are the property of their respective owners. The use of the word partner does not imply a partnership relationship between Cisco and any other company.

June 2013

## Profile 65” using C60

### UNIT DELIVERED COMPLETE WITH:

- Full HD LCD display, Codec C60, Touch 8” user interface device, remote control, PrecisionHD 1080p Camera, microphones, Digital Audio Module, integrated speakers and integrated cabling.

### MONITOR available with:

- 65” Full HD LCD, 16:9, 1080 × 1920 resolution

### BASE available with:

- Floor standing footplate
- Wall mount on pedestal

### BANDWIDTH

The same as Codec C60

### FIREWALL TRAVERSAL

The same as Codec C60

### VIDEO STANDARDS

The same as Codec C60

### VIDEO FEATURES

The same as Codec C60

### VIDEO INPUTS (5 INPUTS)

The same as Codec C60

### VIDEO OUTPUTS (3 OUTPUTS)

The same as Codec C60

### LIVE VIDEO RESOLUTIONS (ENCODE/DECODE)

The same as Codec C60

### AUDIO STANDARDS

The same as Codec C60

### AUDIO FEATURES

The same as Codec C60

### AUDIO INPUTS (7 INPUTS)

The same as Codec C60

### AUDIO OUTPUTS (3 OUTPUTS)

The same as Codec C60

### DUAL STREAM

The same as Codec C60

### MULTIPOINT SUPPORT

The same as Codec C60

### MULTISITE FEATURES\*

The same as Codec C60

### PROTOCOLS

The same as Codec C60

### EMBEDDED ENCRYPTION

The same as Codec C60

### IP NETWORK FEATURES

The same as Codec C60

### IPV6 NETWORK SUPPORT

The same as Codec C60

### CISCO UNIFIED COMMUNICATIONS MANAGER

The same as Codec C60

### SECURITY FEATURES

The same as Codec C60

### NETWORK INTERFACES

The same as Codec C60

### OTHER INTERFACES

The same as Codec C60

### PRECISIONHD 1080P CAMERA

The same as Codec C60

### SYSTEM MANAGEMENT

- The same as Codec C60, as well as
- Cisco TelePresence Touch 8” user interface device

### DIRECTORY SERVICES

The same as Codec C60

### POWER

- Auto-sensing power supply
- 100-120/200-240 VAC, 60/50Hz
- 175 W max for codec and main camera
- Maximum power rating complete system, 650 W

### OPERATING TEMPERATURE AND HUMIDITY

- 0° C to 35° C (32° F to 95° F) ambient temperature
- 10% to 90% relative humidity (RH)

### STORAGE AND TRANSPORT TEMPERATURE

- -20° C to 60° C (-4° F to 140° F) at RH 10-90% (non-condensing)

### DIMENSIONS

- Height: 65 in. / 165 cm
- Width: 59.1 in. / 150 cm
- Depth: 5.9 in. / 15 cm
- Weight: 330 lbs / 150 kg (with floor standing footplate)

### APPROVALS

#### EU/EEC

- Directive 2006/95/EC (Low Voltage Directive)
  - Standard EN 60950-1
- Directive 2004/108/EC (EMC Directive)
  - Standard EN 55022, Class A
  - Standard EN 55024
  - Standard EN 61000-3-2/-3-3
- Directive 2011/65/EU (RoHS)

Warning: This is a class A product. In a domestic environment this product may cause radio interference in which case the user may be required to take adequate measures.

#### USA

- Approved according to UL 60950-1
- Complies with FCC15B Class A

Note: This equipment has been tested and found to comply with the limits for a Class A digital device, pursuant to part 15 of the FCC Rules. These limits are designed to provide reasonable protection against harmful interference when the equipment is operated in a commercial environment. This equipment generates, uses, and can radiate radio frequency energy and, if not installed and used in accordance with the instruction manual, may cause harmful interference to radio communications. Operation of this equipment in a residential area is likely to cause harmful interference in which case the user will be required to correct the interference at his own expense.

#### Canada

- Approved according to CAN/CSA C22.2 No. 60950-1
- This Class A digital apparatus complies with Canadian ICES-003
- Cet appareil numérique de la classe A est conforme à la norme NMB-003 du Canada

### MTBF PRODUCT RELIABILITY/MTBF

The predicted reliability is expressed in the expected random Mean Time Between Failures (MTBF) for the electronic components based on the Power On Hours:

Power On Hours (POH) > 69 000 hours

Useful Life Cycle > 6 years

ISO 9001 certificate is available upon request

All specifications are subject to change without notice, system specifics may vary.

All images in these materials are for representational purposes only, actual products may differ.

Cisco and the Cisco Logo are trademarks of Cisco Systems, Inc. and/or its affiliates in the U.S. and other countries. A listing of Cisco's trademarks can be found at [www.cisco.com/go/trademarks](http://www.cisco.com/go/trademarks). Third party trademarks mentioned are the property of their respective owners. The use of the word partner does not imply a partnership relationship between Cisco and any other company.

June 2013

\* Requires option

## Profile 42"/52"/55" using C40

### UNIT DELIVERED COMPLETE WITH:

- Full HD LCD display, Codec C40, Touch 8" user interface device, remote control, PrecisionHD Camera (1080p), microphones (2x), Digital Audio Module, integrated speakers and integrated cabling.
- Choice of installation configuration: floor stand, wheel base or wall mount on pedestal.

### MONITOR available with:

- 42" Full HD LCD, 16:9, 1080 × 1920 resolution
- 52" Full HD LCD, 16:9, 1080 × 1920 resolution
- 55" Full HD LCD, 16:9, 1080 × 1920 resolution

### BASE available with:

- Floor standing footplate
- Wheel base
- Wall mount on pedestal

### BANDWIDTH

The same as Codec C40

### FIREWALL TRAVERSAL

The same as Codec C40

### VIDEO STANDARDS

The same as Codec C40

### VIDEO FEATURES

The same as Codec C40

### VIDEO INPUTS (4 INPUTS)

The same as Codec C40

### VIDEO OUTPUTS (2 OUTPUTS)

The same as Codec C40

### LIVE VIDEO RESOLUTIONS (ENCODE/DECODE)

The same as Codec C40

### AUDIO STANDARDS

The same as Codec C40

### AUDIO FEATURES

The same as Codec C40

### AUDIO INPUTS (5 INPUTS)

The same as Codec C40

### AUDIO OUTPUTS (3 OUTPUTS)

The same as Codec C40

### DUAL STREAM

The same as Codec C40

### MULTIPOINT SUPPORT

The same as Codec C40

### MULTISITE FEATURES\*

The same as Codec C40

### PROTOCOLS

The same as Codec C40

### EMBEDDED ENCRYPTION

The same as Codec C40

### IP NETWORK FEATURES

The same as Codec C40

### IPV6 NETWORK SUPPORT

The same as Codec C40

### CISCO UNIFIED COMMUNICATIONS MANAGER

The same as Codec C40

### SECURITY FEATURES

The same as Codec C40

### NETWORK INTERFACES

The same as Codec C40

### OTHER INTERFACES

The same as Codec C40

### PRECISIONHD 1080P CAMERA

The same as Codec C40 with 12 × zoom camera

### SYSTEM MANAGEMENT

- The same as Codec C40, as well as
- Cisco TelePresence Touch 8" user interface device

### DIRECTORY SERVICES

The same as Codec C40

### POWER

#### Profile 42"

- Auto-sensing power supply
- 100-120/200-240 VAC, 60/50Hz, 6 A max
- 175W max for codec and main camera
- Maximum power rating complete system 365W

#### Profile 52"

- Auto-sensing power supply
- 100-120/200-240 VAC, 60/50Hz, 6 A max
- 175W max for codec and main camera
- Maximum power rating complete system 526 W

#### Profile 55"

- Auto-sensing power supply
- 100-120/200-240 VAC, 60/50Hz, 4.5 A max
- 175W max for codec and main camera
- Maximum power rating complete system, 350 W
- The display complies with ENERGY STAR requirements

### OPERATING TEMPERATURE AND HUMIDITY

- 0° C to 35° C (32° F to 95° F) ambient temperature
- 10% to 90% relative humidity (RH)

### STORAGE AND TRANSPORT TEMPERATURE

- -20° C to 60° C (-4° F to 140° F) at RH 10-90% (non-condensing)

### DIMENSIONS

#### Profile 42"

- Height: 63.78in. / 162 cm
- Width: 38.58in. / 98 cm
- Depth: 6.7in. / 17 cm
- Weight: 220.5lbs / 100 kg (with floor standing footplate)
- 200.6lbs / 91 kg (with wheel base)

#### Profile 52"

- Height: 63.78in. / 162 cm
- Width: 47.25in. / 120 cm
- Depth: 6.7in. / 17 cm
- Weight: 253.5lbs / 115 kg (with floor standing footplate)
- 229.3lbs / 104 kg (with wheel base)

#### Profile 55"

- Height: 64.6in. / 164 cm
- Width: 49.6in. / 126 cm
- Depth: 6.7in. / 17 cm (without footplate)
- Weight: 245lbs / 111 kg (with floor standing footplate)
- 225lbs / 102 kg (with wheel base)

\* Requires option

**APPROVALS****EU/EEC**

- Directive 2006/95/EC (Low Voltage Directive)
  - Standard EN60950-1
- Directive 2004/108/EC (EMC Directive)
  - Standard EN55022, Class A
  - Standard EN55024
  - Standard EN61000-3-2/-3-3
- Directive 2011/65/EU (RoHS)

Warning: This is a class A product. In a domestic environment this product may cause radio interference in which case the user may be required to take adequate measures.

**USA**

- Approved according to UL60950-1
- Complies with FCC15B Class A

Note: This equipment has been tested and found to comply with the limits for a Class A digital device, pursuant to part 15 of the FCC Rules. These limits are designed to provide reasonable protection against harmful interference when the equipment is operated in a commercial environment. This equipment generates, uses, and can radiate radio frequency energy and, if not installed and used in accordance with the instruction manual, may cause harmful interference to radio communications. Operation of this equipment in a residential area is likely to cause harmful interference in which case the user will be required to correct the interference at his own expense.

**Canada**

- Approved according to CAN/CSA C22.2 No. 60950-1
- This Class A digital apparatus complies with Canadian ICES-003
- Cet appareil numérique de la classe A est conforme à la norme NMB-003 du Canada

**MTBF PRODUCT RELIABILITY/MTBF**

The predicted reliability is expressed in the expected random Mean Time Between Failures (MTBF) for the electronic components based on the Power On Hours:

Power On Hours (POH) > 69 000 hours

Useful Life Cycle > 6 years

ISO 9001 certificate is available upon request

All specifications are subject to change without notice, system specifics may vary.

All images in these materials are for representational purposes only, actual products may differ.

Cisco and the Cisco Logo are trademarks of Cisco Systems, Inc. and/or its affiliates in the U.S. and other countries. A listing of Cisco's trademarks can be found at [www.cisco.com/go/trademarks](http://www.cisco.com/go/trademarks). Third party trademarks mentioned are the property of their respective owners. The use of the word partner does not imply a partnership relationship between Cisco and any other company.

June 2013

## Supported RFCs

The RFC (Request for Comments) series contains technical and organizational documents about the Internet, including the technical specifications and policy documents produced by the Internet Engineering Task Force (IETF).

### Current RFCs and drafts supported

- RFC 2190 RTP Payload Format for H.263 Video Streams
- RFC 2460 Internet protocol, version 6 (IPv6) specification
- RFC 2617 Digest Authentication
- RFC 2782 DNS RR for specifying the location of services (DNS SRV)
- RFC 2976 The SIP INFO Method
- RFC 3016 RTP Payload Format for MPEG-4 Audio/Visual Streams
- RFC 3261 SIP: Session Initiation Protocol
- RFC 3262 Reliability of Provisional Responses in SIP
- RFC 3263 Locating SIP Servers
- RFC 3264 An Offer/Answer Model with SDP
- RFC 3311 UPDATE method
- RFC 3361 DHCP Option for SIP Servers
- RFC 3388 Grouping of Media Lines in the Session Description Protocol (SDP)
- RFC 3420 Internet Media Type message/sipfrag
- RFC 3515 Refer method
- RFC 3550 RTP: A Transport Protocol for Real-Time Applications
- RFC 3551 RTP Profile for Audio and Video Conferences with Minimal Control
- RFC 3581 Symmetric Response Routing
- RFC 3605 RTCP attribute in SDP
- RFC 3711 The Secure Real-time Transport Protocol (SRTP)
- RFC 3840 Indicating User Agent Capabilities in SIP
- RFC 3890 A Transport Independent Bandwidth Modifier for SDP
- RFC 3891 The SIP “Replaces” Header
- RFC 3892 Referred-By Mechanism
- RFC 3960 Early Media
- RFC 3986 Uniform Resource Identifier (URI): Generic Syntax
- RFC 4028 Session Timers in SIP
- RFC 4091 The Alternative Network Address Types (ANAT) Semantics for the Session Description Protocol (SDP) Grouping Framework
- RFC 4092 Usage of the Session Description Protocol (SDP) Alternative Network Address Types (ANAT) Semantics in the Session Initiation Protocol (SIP)
- RFC 4145 TCP-Based Media Transport in the SDP
- RFC 4235 An INVITE-Initiated Dialog Event Package for the Session Initiation Protocol (SIP)
- RFC 4566 SDP: Session Description Protocol
- RFC 4568 SDP: Security Descriptions for Media Streams
- RFC 4574 The Session Description Protocol (SDP) Label Attribute
- RFC 4582 The Binary Floor Control Protocol draft-ietf-bfcpbis-rfc4582bis-00 Revision of the Binary Floor Control Protocol (BFCP) for use over an unreliable transport
- RFC 4583 Session Description Protocol (SDP) Format for Binary Floor Control Protocol (BFCP) Streams draft-ietf-bfcpbis-rfc4583bis-00 Session Description Protocol (SDP) Format for Binary Floor Control Protocol (BFCP) Streams
- RFC 4585 Extended RTP Profile for RTCP-Based Feedback
- RFC 4587 RTP Payload Format for H.261 Video Streams
- RFC 4629 RTP Payload Format for ITU-T Rec. H.263 Video
- RFC 4733 RTP Payload for DTMF Digits, Telephony Tones and Telephony Signals
- RFC 4796 The SDP Content Attribute
- RFC 4862 IPv6 stateless address autoconfiguration
- RFC 5104 Codec Control Messages in the RTP Audio-Visual Profile with Feedback (AVPF)
- RFC 5168 XML Schema for Media Control
- RFC 5245 Interactive Connectivity Establishment (ICE): A Protocol for Network Address Translator (NAT) Traversal for Offer/Answer Protocols
- RFC 5389 Session Traversal Utilities for NAT (STUN)
- RFC 5577 RTP Payload Format for ITU-T Recommendation G.722.1
- RFC 5589: SIP Call Control Transfer
- RFC 5626 Managing Client-Initiated Connections in the Session Initiation Protocol (SIP)
- RFC 5766 Traversal Using Relays around NAT (TURN): Relay Extensions to Session Traversal Utilities for NAT (STUN)
- RFC 5768 Indicating Support for Interactive Connectivity Establishment (ICE) in the Session Initiation Protocol (SIP)
- RFC 5905 Network Time Protocol Version 4: Protocol and Algorithms Specification
- RFC 6156 Traversal Using Relays around NAT (TURN) Extension for IPv6
- RFC 6184 RTP Payload Format for H.264 Video

## User documentation on the Cisco web site

In general, user documentation for the Cisco TelePresence products is available here:

▶ <http://www.cisco.com/go/telepresence/docs>

You have to choose your product category in the right pane until you find your product. Follow one of these paths:

*TelePresence Integration Solutions* >  
*Cisco TelePresence Integrator C Series*

*Collaboration Room Endpoints* >  
*Cisco TelePresence Profile Series*

Alternatively, you can use the following short-links to find the documentation:

▶ <http://www.cisco.com/go/cseries-docs>

▶ <http://www.cisco.com/go/profile-docs>

The documents are organized in the following categories:

**Installation guides:**

*Install and Upgrade* > *Install and Upgrade Guides*

**Getting started guide:**

*Install and Upgrade* > *Install and Upgrade Guides*  
*Maintain and Operate* > *Maintain and Operate Guides*

**Administrator guides:**

*Maintain and Operate* > *Maintain and Operate Guides*

**User guides and Quick reference guides:**

*Maintain and Operate* > *End-User Guides*

**API reference guides:**

*Reference Guides* | *Command references*

**Knowledge base articles and frequently asked questions:**

*Troubleshoot and Alerts* > *Troubleshooting Guides*

**Physical interface guides:**

*Maintain and Operate* | *End-User Guides*

**CAD drawings:**

*Reference Guides* > *Technical References*

**TC Console user guide:**

*Configure* > *Configuration Guides*

**Video conferencing room guidelines:**

*Design* > *Design Guides*

**Software licensing information:**

*Software Downloads, Release and General Information* > *Licensing Information*

**Regulatory compliance and safety information:**

*Install and Upgrade* > *Install and Upgrade Guides*

**Software release notes:**

*Software Downloads, Release and General Information* > *Release Notes*

## Intellectual property rights

THE SPECIFICATIONS AND INFORMATION REGARDING THE PRODUCTS IN THIS MANUAL ARE SUBJECT TO CHANGE WITHOUT NOTICE. ALL STATEMENTS, INFORMATION, AND RECOMMENDATIONS IN THIS MANUAL ARE BELIEVED TO BE ACCURATE BUT ARE PRESENTED WITHOUT WARRANTY OF ANY KIND, EXPRESS OR IMPLIED. USERS MUST TAKE FULL RESPONSIBILITY FOR THEIR APPLICATION OF ANY PRODUCTS.

THE SOFTWARE LICENSE AND LIMITED WARRANTY FOR THE ACCOMPANYING PRODUCT ARE SET FORTH IN THE INFORMATION PACKET THAT SHIPPED WITH THE PRODUCT AND ARE INCORPORATED HEREIN BY THIS REFERENCE. IF YOU ARE UNABLE TO LOCATE THE SOFTWARE LICENSE OR LIMITED WARRANTY, CONTACT YOUR CISCO REPRESENTATIVE FOR A COPY.

The Cisco implementation of TCP header compression is an adaptation of a program developed by the University of California, Berkeley (UCB) as part of UCB's public domain version of the UNIX operating system. All rights reserved. Copyright © 1981, Regents of the University of California.

NOTWITHSTANDING ANY OTHER WARRANTY HEREIN, ALL DOCUMENT FILES AND SOFTWARE OF THESE SUPPLIERS ARE PROVIDED "AS IS" WITH ALL FAULTS. CISCO AND THE ABOVE-NAMED SUPPLIERS DISCLAIM ALL WARRANTIES, EXPRESSED OR IMPLIED, INCLUDING, WITHOUT LIMITATION, THOSE OF MERCHANTABILITY, FITNESS FOR A PARTICULAR PURPOSE AND NONINFRINGEMENT OR ARISING FROM A COURSE OF DEALING, USAGE, OR TRADE PRACTICE.

IN NO EVENT SHALL CISCO OR ITS SUPPLIERS BE LIABLE FOR ANY INDIRECT, SPECIAL, CONSEQUENTIAL, OR INCIDENTAL DAMAGES, INCLUDING, WITHOUT LIMITATION, LOST PROFITS OR LOSS OR DAMAGE TO DATA ARISING OUT OF THE USE OR INABILITY TO USE THIS MANUAL, EVEN IF CISCO OR ITS SUPPLIERS HAVE BEEN ADVISED OF THE POSSIBILITY OF SUCH DAMAGES.

Cisco and the Cisco Logo are trademarks of Cisco Systems, Inc. and/or its affiliates in the U.S. and other countries. A listing of Cisco's trademarks can be found at [www.cisco.com/go/trademarks](http://www.cisco.com/go/trademarks). Third party trademarks mentioned are the property of their respective owners. The use of the word partner does not imply a partnership relationship between Cisco and any other company. (1005R)

Any Internet Protocol (IP) addresses and phone numbers used in this document are not intended to be actual addresses and phone numbers. Any examples, command display output, network topology diagrams, and other figures included in the document are shown for illustrative purposes only. Any use of actual IP addresses or phone numbers in illustrative content is unintentional and coincidental.

TANDBERG is now a part of Cisco. TANDBERG® is a registered trademark belonging to Tandberg ASA.

## Cisco contacts

On our web site you will find an overview of the worldwide Cisco contacts.

Go to: ► <http://www.cisco.com/web/siteassets/contacts>

Corporate Headquarters  
Cisco Systems, Inc.  
170 West Tasman Dr.  
San Jose, CA 95134 USA