



Cisco Expressway Options with Cisco Meeting Server and/or Microsoft Infrastructure

Deployment Guide

First Published: December 2016

Last Updated: October 2017

Expressway X8.9.2

Preface

Change History

Table 1 Deployment Guide Change History

Date	Change	Reason
October 2017	Clarified load distribution and redundancy limitation documented in previous change, about Web Proxy to clustered Meeting Server. Changed Web Proxy call capacity from 750 to 500.	Document defects
October 2017	Removed support for multiple web bridges. (Invalid, corrected by more recent change)	Product defect
July 2017	Added DNS limitations for federation with Microsoft.	New information
June 2017	Note about clustered Meeting Server not supported in the scenarios presented.	Document defect
May 2017	Document name changed. Clarified where search rules should Stop (they default to Continue). Added Office 365 to list of supported Microsoft federation options. Removed caution about not using Web Proxy for Meeting Server.	X8.9.2 Maintenance release
March 2017	Removed the section "On-Premises Microsoft Options" which are not currently supported. Added pointers to Meeting Server documents that enable similar scenarios.	Untested scenarios
February 2017	Document name changed. Updated information about NOTIFY messages in Microsoft with IM&P federation. IM&P federation now fully supported using IM&P 11.5(1)SU2.	Known issues
January 2017	Updated. CMS version changed.	X8.9.1 Maintenance release
December 2016	First release	X8.9

Related Documents

- For installing Expressway:
 - *Cisco Expressway Virtual Machine Installation Guide* on the [Expressway installation guides page](#).
 - *Cisco VCS Virtual Machine Installation Guide* on the [VCS installation guides page](#).
 - *Cisco Expressway CE1100 Appliance Installation Guide* on the [Expressway installation guides page](#).
 - *Cisco Video Communication Server CE1100 Appliance Installation Guide* on the [VCS installation guides page](#).
- [Cisco Meeting Server installation guides page](#)
- [Cisco Meeting Server configuration guides page](#)
- [Expressway Administrator Guide](#)
[VCS Administrator Guide](#)

Preface

- For certificates on Expressway:
See *Cisco Expressway Certificate Creation and Use Deployment Guide* on the [Expressway configuration guides page](#).
See *Cisco VCS Certificate Creation and Use Deployment Guide* on the [VCS configuration guides page](#).
- For clustering Expressway:
See the *Cisco VCS Cluster Creation and Maintenance Deployment Guide*, for your version, on the [Cisco TelePresence Video Communication Server \(VCS\) configuration guides page](#).
See the *Cisco Expressway Cluster Creation and Maintenance Deployment Guide*, for your version, on the [Cisco Expressway Series configuration guides page](#).
- For firewall configuration:
See the *Cisco Expressway IP Port Usage Configuration Guide*, for your version, on the [Cisco Expressway Series configuration guides page](#).

Contents

Preface	3
Change History	3
Related Documents	3
Contents	5
Introduction	7
Scope and Purpose	7
Unified CM-centric Deployment Map	9
Expressway-centric Deployment Map	10
Terminology and Example Values	11
Building Block Examples	13
Example: Route Standard SIP Calls to Meeting Server	13
Example: Configure Meeting Server to Transcode Standards-based to Microsoft Variant SIP	14
Example: Route Microsoft SIP from Expressway-C to Federated Microsoft Organization	15
Example: Route Inbound Microsoft SIP from Expressway-E to Meeting Server	16
Core Configuration	19
Prerequisites	20
Create Traversal Server and Client Zones	20
Neighbor the Expressway-C to Cisco Meeting Server	22
Which TURN Server To Use?	22
Configure Meeting Server to Use Expressway-E for TCP TURN Services	23
Modular Deployment Options	25
"Named Federation" Video Calls Between Two Standards-based Organizations (B2B)	26
"Named Federation" Video Calls Between Cisco-based and Microsoft-based Organizations	31
"Open Federation" Video Calls With Microsoft Clients in External Domains	37
Audio/Video Meetings in Meeting Server Spaces	43
Meeting Server Calling Out	47
High Scale Calls and Meetings with Unified CM and Meeting Server	50
IM&P Federation With Microsoft-based Organizations	56
Web Proxy for Cisco Meeting Server	62
Appendix 1: DNS Entries	70
External DNS Records	70
Internal DNS Records	72
Appendix 2: Unsupported Deployments	74
[Unsupported] Unified CM Invoking Meeting Server as a Transcoder (MRG)	74
[Unsupported] Expressway Pair Traversing on Behalf of Microsoft On-Premises Infrastructure	75
Appendix 3: Licensing and Performance	76
Deployment License Usage on Large Expressway	76
Deployment License Usage on Large VCS	76
Cisco Legal Information	78
Cisco Trademark	78

Introduction

This document applies equally to Cisco TelePresence Video Communication Server (VCS) and Cisco Expressway Series (Expressway). The Expressway products and names are used throughout, but you can interchange those with VCS equivalents and infer the same meaning.

We describe the differences where necessary, because there is no corresponding VCS document.

Scope and Purpose

This document describes how to use Cisco Expressway Series and Cisco Meeting Server to enable multiple collaboration scenarios between the following systems:

- Your on-premises SIP collaboration environment, which the document distinguishes into two categories:
 - Cisco Unified Communications Manager-centric call control
 - Third-party or Expressway-centric call control
- Cisco Meeting Server spaces
- Cisco collaboration clients in other organizations
- Cisco Meeting Application (on premises)

Note: Expressway cannot currently traverse calls from/to Cisco Meeting Application when it is outside the network. This functionality can be provided by using the Meeting Server Load Balancer and TURN server components.

See *Deploying the Trunk and the Load Balancer* and *Configuring TURN Servers* in the Meeting Server deployment guides, on the [Cisco Meeting Server configuration guides page](#).

- WebRTC Clients
- Jabber clients, registered to Cisco Unified Communications Manager IM and Presence Service
- Microsoft clients on Lync or Skype for Business infrastructure in other organizations, or Skype for Business clients on Office 365

Note: We do not interoperate with "consumer" versions of Skype.

This document does not cover the following scenarios:

- Interoperability between on premises Microsoft infrastructure and Meeting Server. In this scenario, the Cisco Meeting Server must use the Microsoft Edge server to traverse Microsoft calls into and out of the organization. See the Microsoft integration topics in the Meeting Server deployment guides, at [Cisco Meeting Server configuration guides page](#).
- Clustered Meeting Servers are not currently supported in the scenarios described here.

The scenarios in this document use the following Expressway tools in combination:

- A search rule filter for different implementations of the SIP protocol.
- A DNS zone that searches for different SRV records, depending on the SIP variant.
- A reverse https proxy for Meeting Server web bridges.

Because these tools are simple and build on established Expressway behavior, this document is deliberately light on configuration detail. Instead, we give a configuration summary and related reading where you may need it. Each configuration summary lists the steps needed to complete a particular task, and each step includes the menu option you need. From the menu options you can generally access online help for detailed information, or you can refer to the appropriate configuration guide.

Introduction

Document Structure

There are two 'deployment maps' in this section. The first shows Unified CM as the primary standards-based call control agent on-premises, and the other shows a generic call control agent or Expressway registrar.

The deployment maps show many of the anticipated scenarios overlaid on one picture; you may not need to configure everything on the map! Also, the maps illustrate the signaling connections. Media will not usually flow through all of the systems in the signaling path.

We've tried to structure the document to show you how to implement new options onto your existing environment without being too prescriptive. For that reason, the document starts with examples of the building blocks that are used to implement the call flows shown on the map.

Then we summarize the minimum 'core configuration' you'll need before you can implement new functionality.

The rest of the document body uses diagrams and sample dial plans to describe different options. The options are modular and can be used together or separately to suit your requirements.

Note: This is not an exhaustive list and your scenario may not be represented. We've tried to give you a flavor of the possibilities without making the document too long.

Unified CM-centric Deployment Map

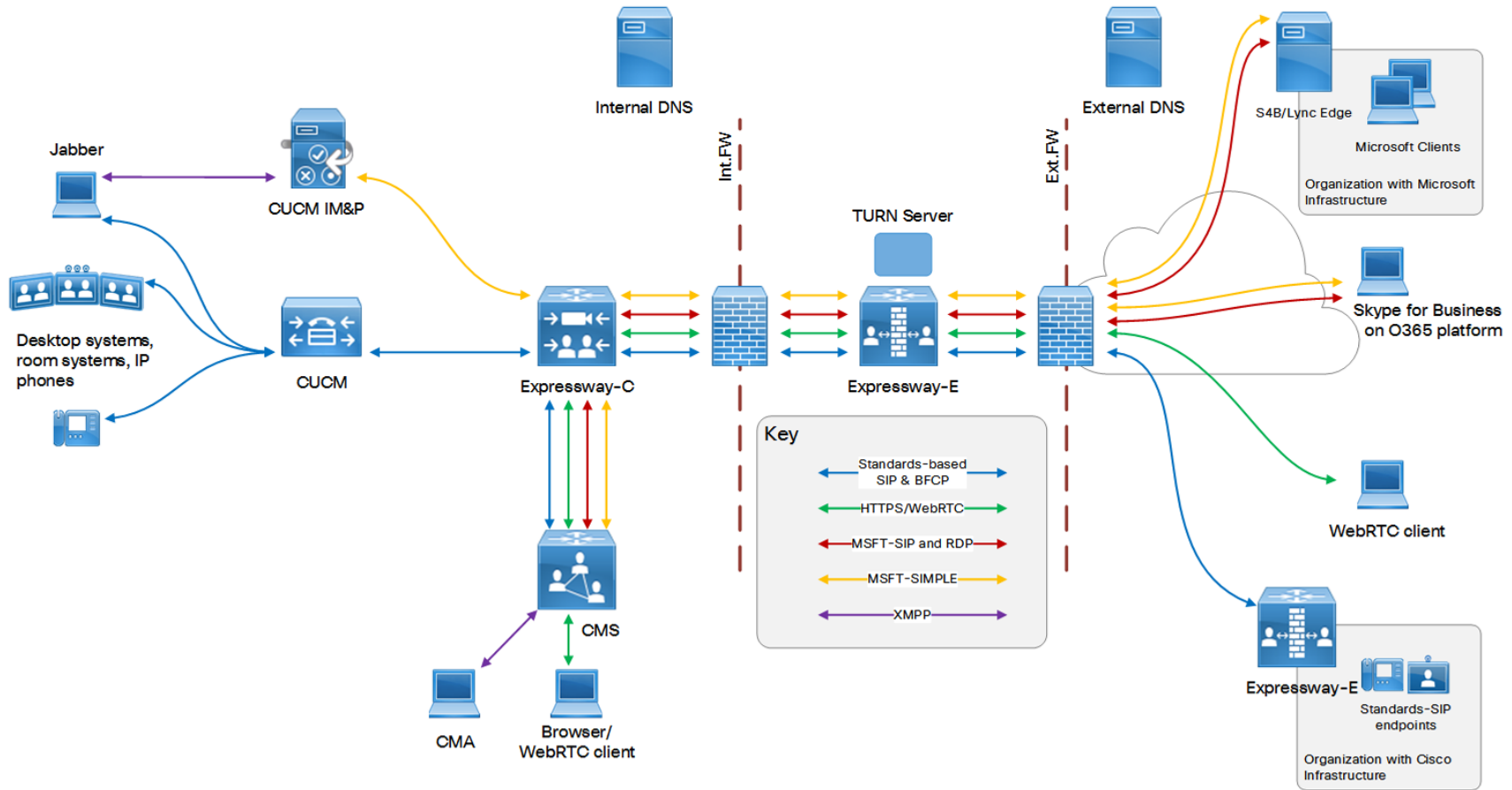

Expressway-centric Deployment Map

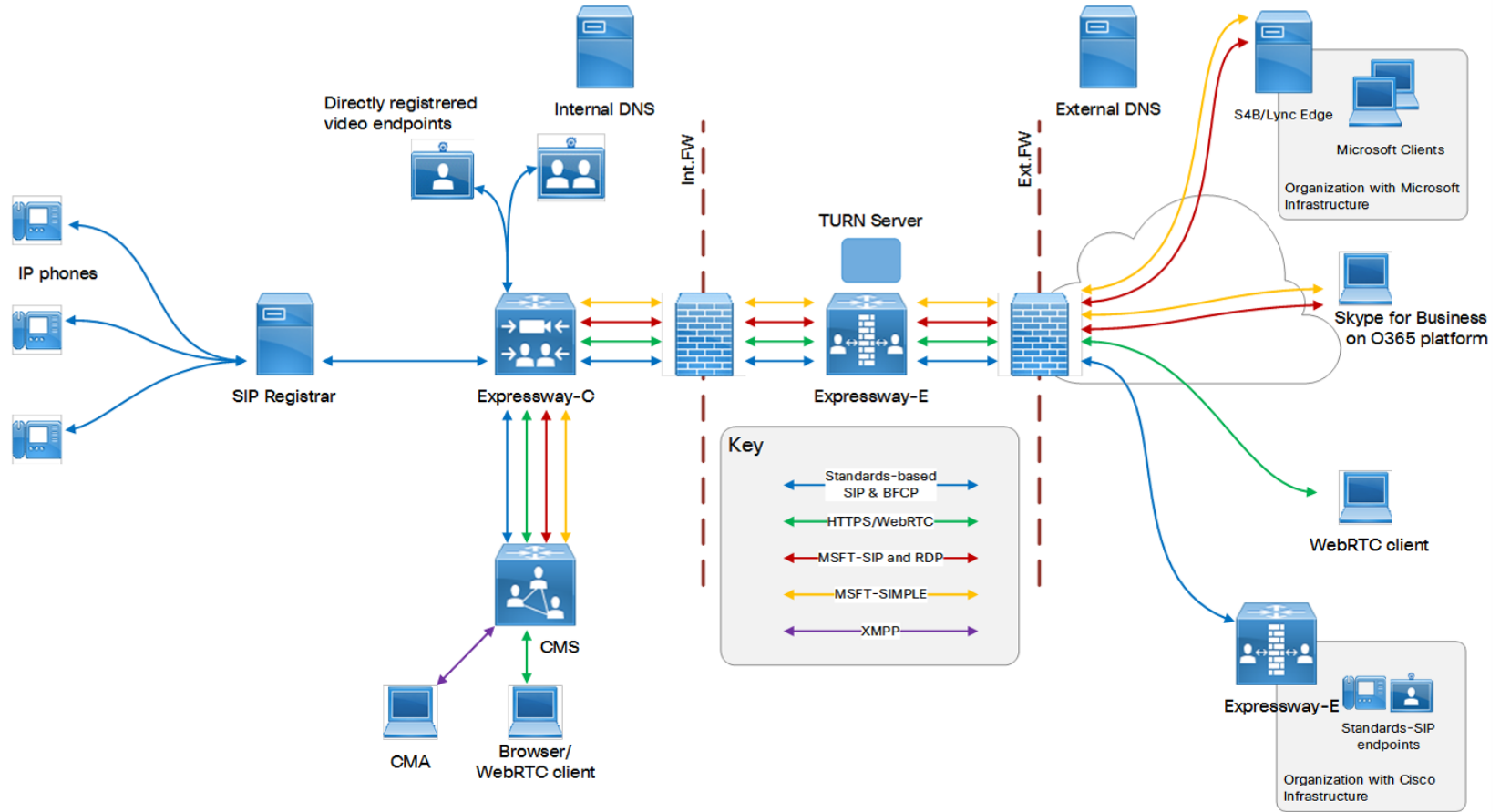

Terminology and Example Values

Note: Do not use the domain names and other example values from this document in your test or production deployments. You must change the example values to represent your own environment.

- **Web Proxy for Meeting Server:** A reverse https proxy on the Expressway traversal pair used only for a specified address.
- **Meeting Server listening address:** A name that you enter on the Expressway-C to represent the Web Bridge listening interfaces on the Cisco Meeting Server. It corresponds to the **Guest account client URI** on the Meeting Server web bridge settings. We use the example value *join.ciscoexample.com*.

Note: The **Meeting Server listening address** parameter on Expressway-C will be renamed to correspond with the name used on Meeting Server. This document does not use the term anywhere else.

- **Federation:** Federation in this context means connecting users in two or more organizations using collaboration technologies.
- **Our organization:** An organization using on-premises Cisco collaboration infrastructure to federate with other organizations. It is shown on the left hand side of all topology diagrams in this document, and uses the example domain *ciscoexample.com*.
- **Traversal server / client zones:** Special zones on the Expressway-E and Expressway-C that enable the pair to traverse calls across firewalls. You can use Unified Communications zones instead - and you must use this type for the Web Proxy for Meeting Server - but in this document we call the zones traversal server and traversal client, to simplify understanding.
- **Named Federation:** means connecting users from 'our' organization with users from specific organizations. We know the target domains in advance. In this document we'll use the value *msexample.com* for a named Microsoft-based organization and *ciscob2b.com* for a named Cisco-based organization.
- **Open Federation:** means connecting users from 'our' organization with users in organizations whose domains we don't know in advance.
- **Interdomain Federation:** On-premises federation between different SIP domains. This is necessary when different SIP domains are used by Microsoft infrastructure and Cisco infrastructure. In this document, we use *ourmsexample.com* for the SIP domain used by on-premises Microsoft infrastructure.
- **User contact URIs:** User A in our organization calls *userC@msexample.com*, and User C in the federated organization calls *userA@ciscoexample.com*.
- **Meeting Server space contact URIs:** User B invites folks to join the space *userb.space@cms.ciscoexample.com*

We recommend using a subdomain for your conferences because some call agents cannot make routing decisions based on the username part of the requested URI. For example, we suggest that you use the form *user1.space@cms.ciscoexample.com* in your dial plan instead of *user1.space@ciscoexample.com*.

- **Outbound and Inbound:** Generally, calls initiated from inside our organization's network to another organization or remote user are Outbound. Calls initiated from outside our organization's network, to users or spaces in our network, are Inbound.

We also use these terms in the specific context of particular systems. In these cases, you can infer the call direction from the text and supporting diagrams.

- **Gateway Meeting Server:** A normal Meeting Server that is only used for adapting between different SIP variants.
- **Conferencing Meeting Server:** A normal Meeting Server that is dedicated to hosting spaces.

Building Block Examples

The examples in this section illustrate and summarize some configuration tasks. They are not useful on their own, but they are included here for two reasons:

- They introduce the format of the modular deployment scenarios: diagram, sample dial plan, and configuration summary.
- They illustrate how a typical deployment scenario is built up from smaller configuration tasks.

The examples here can be combined to implement outbound calling from standards-based SIP endpoints to Microsoft clients in federated organizations.

Example: Route Standard SIP Calls to Meeting Server	13
Example: Configure Meeting Server to Transcode Standards-based to Microsoft Variant SIP	14
Example: Route Microsoft SIP from Expressway-C to Federated Microsoft Organization	15
Example: Route Inbound Microsoft SIP from Expressway-E to Meeting Server	16

Example: Route Standard SIP Calls to Meeting Server

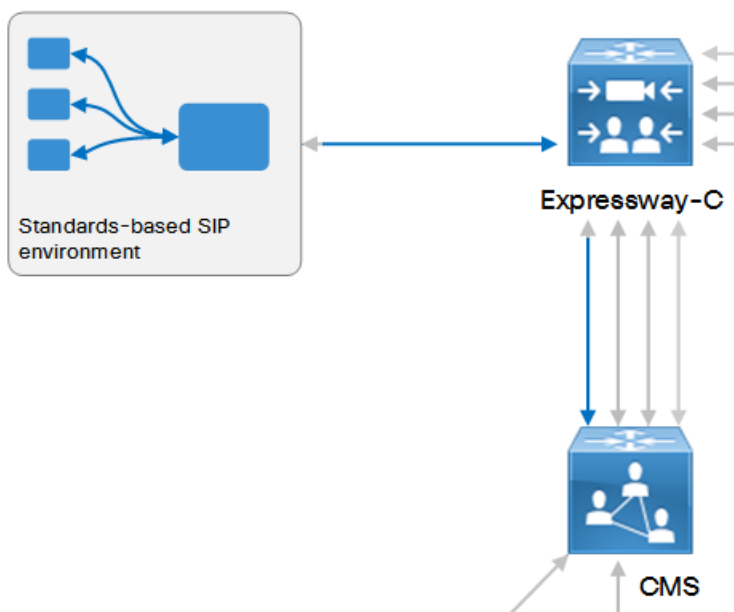

To enable standards-based endpoints to call into spaces, you would use a Standard SIP search rule that looks for the Meeting Server space dial pattern (for example, *userb.space@cms.ciscoexample.com*).

If you want Meeting Server to adapt the call from a standards-based endpoint to a Microsoft client, you still use a Standards-based search rule, but you search on the *msexample.com* domain instead.

Example Call Flow 1

1. Collaboration endpoint user A dials *userC@msexample.com*.
2. The standards-based SIP registrar recognizes this pattern is for Expressway-C, and routes the call on that trunk/neighbor zone.
3. Your search rule on Expressway-C is looking for calls that come in on the neighbor zone from the standards-based registrar. It is filtering out those calls that use the Standard SIP variant, and are destined for anything ending with *@msexample.com*.

Building Block Examples

- When Expressway-C identifies a call that matches these parameters, it routes the call to the Meeting Server neighbor zone.

Example Call Flow 2

- Collaboration endpoint user A dials *userB.space@cms.ciscoexample.com*.
- The standards-based SIP registrar recognizes this pattern is for its trunk to Expressway-C, and routes the call on that trunk.
- Your search rule on Expressway-C is looking for calls to *cms.ciscoexample.com* that come in on the neighbor zone from the standards-based registrar.
- When Expressway-C identifies a call that matches these parameters, it routes the call to the Meeting Server neighbor zone.

Configuration Summary

- SIP trunk on the registrar to route to Expressway-C.
- Neighbor zone to the registrar from Expressway-C.
- Neighbor zone to Meeting Server on Expressway-C.
- Dial plan that mandates routing the patterns *@msexample.com* and *@cms.ciscoexample.com* via Expressway-C towards Meeting Server.

Dial Plan Description

- Routing rule on the standards-based registrar to send calls for *msexample.com* to the Expressway-C.
- Routing rule on the standards-based registrar to send calls for *cms.ciscoexample.com* to the Expressway-C.
- Search rule on the Expressway-C to send *.*@msexample|.com* to Meeting Server.
- Search rule on the Expressway-C to send *.*@cms|.ciscoexample|.com* to Meeting Server.

Example: Configure Meeting Server to Transcode Standards-based to Microsoft Variant SIP

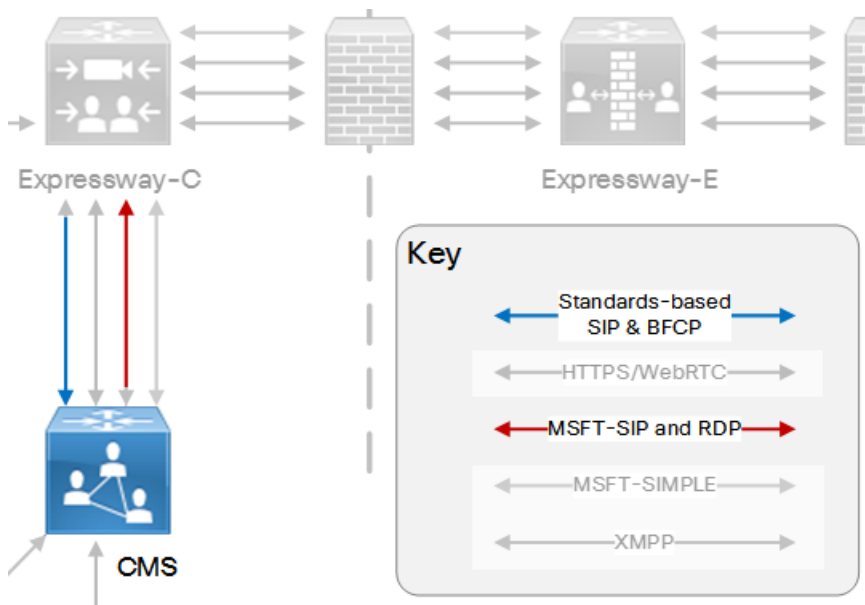

Building Block Examples

Example Call Flow 1

1. Meeting Server receives a Standard SIP call for *userC@msexample.com*.
2. An inbound dial plan rule on Meeting Server is waiting for calls with destination pattern **@msexample.com*.
3. When it identifies a call with that pattern, Meeting Server forwards the call on the Lync type trunk to Expressway-C.

Example Call Flow 2

Meeting Server receives a call for *userB.space@cms.ciscoexample.com* and connects the call to a local space.

Configuration Summary

- Neighbor zone from Expressway-C to Meeting Server.
- Create dial plan.

Dial Plan Description

- Incoming call rule on Meeting Server that is Forwarding calls with the pattern **@msexample.com*.
- Outbound call rule on Meeting Server that sends calls for **@msexample.com* back to Expressway-C (SIP Proxy) using the Lync type.
- Incoming call rule on Meeting Server that is Matching the pattern **@cms.ciscoexample.com*.

Example: Route Microsoft SIP from Expressway-C to Federated Microsoft Organization

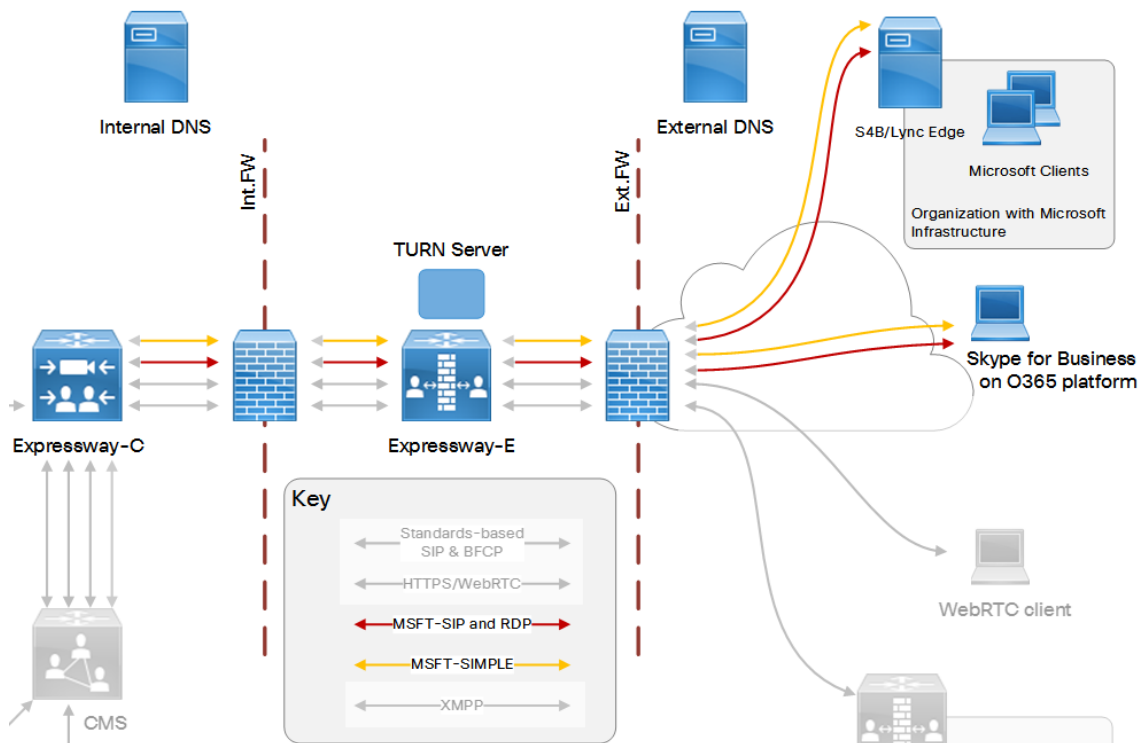

Building Block Examples

Example Call Flow

1. An outbound call for Microsoft user C (*userC@msexample.com*) has been routed to the Traversal client zone (or Unified Communications zone) on the Expressway-C.
2. Your search rule on Expressway-E is looking for calls that come in on the Traversal server zone. It's filtering out those calls for **@msexample.com* that use *Any Microsoft* SIP variant.
3. When Expressway-E identifies a call matching these parameters, it routes the call to the DNS zone.
4. The DNS zone recognizes the Microsoft SIP variant, and does a DNS SRV lookup for `_sipfederation1s._tcp.msexample.com`. This resolves the Lync / Skype for Business Edge servers for the federated organization.
5. The Expressway-E routes the call to the Edge server.
6. The Meeting Server and Microsoft user C's client negotiate a media path using TURN.
7. The call is established.

Configuration Summary

- Traversal server zone on Expressway-E.
- Traversal client zone on Expressway-C.
- DNS zone on Expressway-E.
- Enable TURN server on Expressway-E.
- Point Meeting Server at TURN server on Expressway-E.
- Create dial plan.

Dial Plan Description

- Search rule on Expressway-C to route Microsoft variant SIP, destined for **@msexample.com*, to the traversal client zone.
- Search rule on the Expressway-E to route all calls from the traversal server zone to the DNS zone.

Example: Route Inbound Microsoft SIP from Expressway-E to Meeting Server

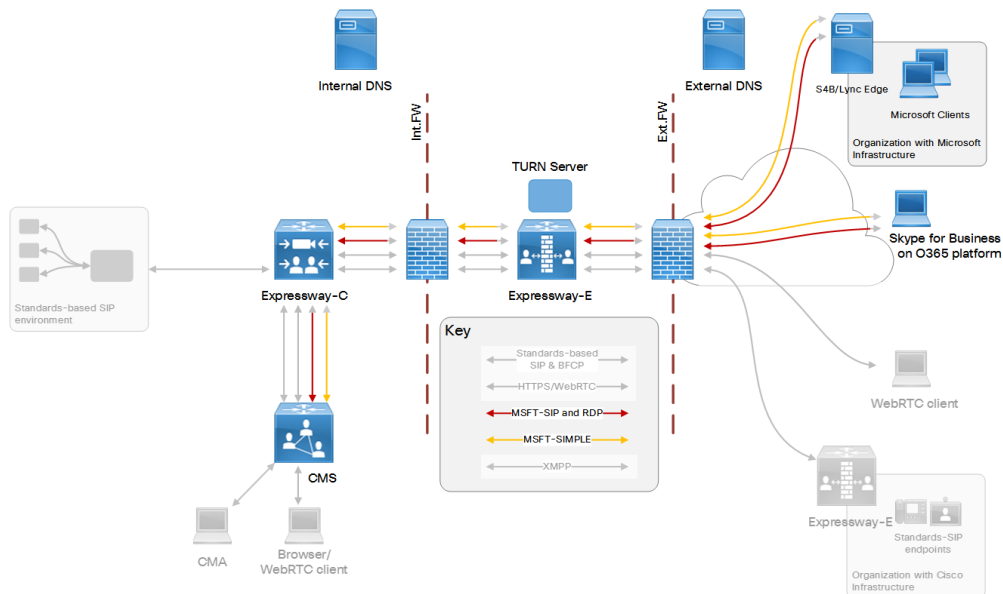

Building Block Examples

Example Call Flow

1. External Microsoft user C (*userC@msexample.com*) calls user B's space (*userB.space@cms.ciscoexample.com*).
2. The Microsoft on-premises or cloud infrastructure does a DNS lookup for `_sipfederationtls._tcp.cms.ciscoexample.com`. (federation SRV record) and routes the call to the Expressway-E public address.
3. Your search rule on Expressway-E is looking for calls that come in on the Default zone. It's filtering calls destined for anything *@cms.ciscoexample.com*.
4. When Expressway-E identifies a call matching these parameters, it routes the call to the traversal server zone. (You could have a Unified Communications zone instead of a traversal server zone.)
5. The call traverses the firewall to the traversal client zone (or Unified Communications zone) on the Expressway-C.
6. Your search rule on Expressway-C is looking for calls that come in on the Traversal client zone. It's filtering out calls destined for anything *@cms.ciscoexample.com*.
7. When Expressway-C identifies a call matching these parameters, it routes the call to the Meeting Server neighbor zone.
8. The Meeting Server and Microsoft user C's client negotiate a media path using TURN.
9. The call is established.

Configuration Summary

- Traversal server zone on Expressway-E.
- Traversal client zone on Expressway-C.
- Neighbor zone to Meeting Server on Expressway-C.
- Enable TURN server on Expressway-E.
- Point Meeting Server at TURN server on Expressway-E.
- Create dial plan.

Dial Plan Description

- Search rule on Expressway-E to route *.*@cms|.ciscoexample|.com* from the default zone to the traversal server zone.
- Search rule on Expressway-C to route *.*@cms|.ciscoexample|.com* from the traversal client zone to the Meeting Server zone.

Core Configuration

This section gives you an overview of the minimum configuration you need to get the Expressway pair working with Cisco Meeting Server. The sections that follow will describe the options for making this core configuration work for your users.

Prerequisites	20
Create Traversal Server and Client Zones	20
Neighbor the Expressway-C to Cisco Meeting Server	22
Which TURN Server To Use?	22
Configure Meeting Server to Use Expressway-E for TCP TURN Services	23

Core Configuration

Prerequisites

Supporting Systems Configuration

- DNS. An internal DNS configured with forward and reverse lookups for Expressway-E, Expressway-C, and Cisco Meeting Server.
- External DNS. An external DNS configured with forward lookup for the Expressway-E cluster FQDN.
Note: The Web Proxy for Meeting Server is affected if you cannot make different entries for internal DNS and external DNS. See [Appendix 1: DNS Entries, page 70](#)
- NTP. All servers must be internally synchronized to the same time source.

Software Versions

- Expressway X8.9 or later
- Cisco Meeting Server 2.1.2 or later
- Meeting Server web bridge 2.1.4 or later is the minimum target for Expressway's Web Proxy for Meeting Server
- Cisco Unified Communications Manager 10.x or later, for the audio / video call deployments shown
- Cisco Unified Communications Manager IM and Presence Service 11.5(1) SU2 or later. This software is only required for chat federation with Microsoft clients
- Microsoft clients on Lync 2013 Server, Skype for Business Server, or Office 365
- Cisco Collaboration endpoints and Microsoft client software

Core Systems Basic Configuration

- Install and basic configuration of Cisco Meeting Server
- Install and basic configuration of Expressway (traversal pair)
- Certificate creation and install onto Expressway
- [Optional] Clustering of Expressway

See [Related Documents, page 3](#), for links to these documents.

Create Traversal Server and Client Zones

1. On each system in the Expressway pair, go to **Configuration > Zones > Zones**.
2. Click **New**.

Core Configuration

3. Configure the following fields (leave all other fields with their default values):

Field Name	Expressway-C	Expressway-E
Name	TraversalClient for example	TraversalServer for example
Type	<i>Traversal client</i> Note: For Meeting Server Web Proxy, you must use Unified Communications zones. Otherwise traversal zones are sufficient.	<i>Traversal server</i>
Connection credentials section		
Username	exampleauth for example	Match the credential entered on Expressway-C. Such as exampleauth
Password	ex4mp13.c0m for example	<ol style="list-style-type: none"> Click Add/Edit local authentication database In the dialog box, click New and enter the Name and Password values. Using our examples, these would be exampleauth and ex4mp13.c0m. Click Create credential.
H.323 section		
Mode	<i>Off</i>	<i>Off</i>
SIP section		
Port	7001	7001
TLS verify subject name	Not applicable	Enter the name to look for in the traversal client's certificate. This must be in either the Subject Common Name or the Subject Alternative Name attributes. If you have a cluster of traversal clients, specify the cluster name here and ensure that it's included in each client certificate.
Authentication section		
Authentication policy	<i>Do not check credentials</i>	<i>Do not check credentials</i>
Location section		
Peer 1 address	Enter the FQDN of the Expressway-E.	Not applicable
Peer 2...6 address	(Clustered Expressway-Es only.) Enter the FQDNs of each additional peer.	Not applicable

4. Click **Create zone**.

Neighbor the Expressway-C to Cisco Meeting Server

1. On the Expressway-C, go to **Configuration > Zones > Zones** and click **New**.
2. Select type *Neighbor*.
3. Configure the following zone parameters (leave all other parameters with their default values) then save the zone:

Table 2 Meeting Server Neighbor Zone Settings

Field Name	Select or Enter This Value
Name	CiscoMeetingServer
H.323 Mode	Off
SIP Mode	On
Transport	TLS
Peer 1 address	FQDN or IP address of the Cisco Meeting Server. Note: Currently, we recommend not to provision multiple peers on the Meeting Server neighbor zone. If multiple peers are provisioned, application sharing will fail during inbound Microsoft AV & Share SIP calls.

Which TURN Server To Use?

Version X8.9 of the Expressway is the first version to replace some of the Cisco Meeting Server Edge functionality, and there are some limitations in X8.9 that we intend to address in future releases.

With the infrastructure scenarios in this document, it is possible that up to three different TURN servers could be required:

- Expressway-E TURN server
- Meeting Server Edge TURN server
- Skype for Business / Lync Edge TURN server

Recommendations

At present, your choice of TURN server depends on your requirements:

- **If you are doing SIP federation only**, between your standards-based organization and another standards-based, or Microsoft-based, organization, then we recommend using the Expressway-E TURN server.
- **If you are using CMA or WebRTC Client**, you must use Meeting Server Edge with the TURN server enabled, because:
 - The Expressway pair does not currently traverse the XMPP protocol used by Cisco Meeting Application.
 - The Expressway-E TURN server does not currently listen on TCP port 443. Many free wifi locations restrict 3478 but allow 443.

One disadvantage of this choice is that the Meeting Server does not currently use different TURN servers for different reasons. If you need SIP federation as well as WebRTC Client access, then you must use the Meeting Server Edge for TURN services.

Core Configuration

- **If you are doing dual homed conferencing** between on-premises Meeting Server and on-premises Microsoft Skype for Business infrastructure, then the Meeting Server automatically uses the Skype for Business Edge for TURN services.

Note: This document describes the use of Expressway-E whenever a TURN server is required. The latter two recommendations above are not considered here. See [Cisco Meeting Server configuration guides page](#) for details of how to configure those deployments.

More on the TURN ports

The Expressway-E has an embedded TURN server which listens on TCP and UDP port 3478. If it is a large Expressway-E, it listens on the range 3478–3483 inclusive. These ports are configurable within the 1024–65535 range.

Meeting Server can use the TURN server on Meeting Server Edge, or the Expressway-E TURN server, or even the Microsoft Lync/Skype for Business Edge server. Also, the WebRTC client and the Cisco Meeting Application use TURN in different ways.

- By default, the Meeting Server's TURN server listens on both TCP and UDP ports 443 and 3478.
- You can change the 443 default on Meeting Server to any port number.
- If the Meeting Server needs to use TCP for TURN, it normally connects to port 3478 if it knows that the destination is a Meeting Server TURN server or Expressway-E TURN server.
- If the WebRTC Client needs to use TCP for TURN, it connects to the configurable TCP port number (typically 443).
- Other versions of Cisco Meeting Application do not currently use TCP for media (only UDP).

Configure Meeting Server to Use Expressway-E for TCP TURN Services

You can use the Meeting Server UI to point it at a TURN server as described here, or you can use the API to modify the `/turnServers` node.

See *Cisco Meeting Server API Reference Guide* on the [Cisco Meeting Server programming guides page](#).

Core Configuration

1. Go to **Configuration > General**.
2. Enter the following values:

Fieldname	Example value / description
TURN Server address (CMS)	This is the address that the Meeting Server uses for TURN requests. If using the Expressway-E TURN server, then it should be the private address of the Expressway-E. You can use an IP address or FQDN in this field.
TURN Server address (CMA)	This is the address that the Cisco Meeting Application (and the WebRTC Client) uses for TURN requests. If using the Expressway-E TURN server, then it should be the public address of the Expressway-E. You can use an IP address or FQDN in this field. Note: The Meeting Server resolves the FQDN before passing the IP address to the clients. This means external clients may be unable to connect (depending on your DNS configuration) because they might be trying an internal IP address.
Username	An account to represent the Meeting Server on the TURN server. You must create the corresponding account on the TURN server.
Password	A secret used to authenticate this account. You must share the secret with the corresponding TURN server account.
Confirm password	Re-enter the value from the previous field.

3. Submit the configuration.

The port defaults to 3478 (UDP & TCP) if Meeting Server detects the Expressway-E TURN server.

You cannot override the TCP TURN port with the UI. If you need to change this port, you must modify the `/turnServers` node with the API.

Modular Deployment Options

"Named Federation" Video Calls Between Two Standards-based Organizations (B2B)	26
"Named Federation" Video Calls Between Cisco-based and Microsoft-based Organizations	31
"Open Federation" Video Calls With Microsoft Clients in External Domains	37
Audio/Video Meetings in Meeting Server Spaces	43
Meeting Server Calling Out	47
High Scale Calls and Meetings with Unified CM and Meeting Server	50
IM&P Federation With Microsoft-based Organizations	56
Web Proxy for Cisco Meeting Server	62

"Named Federation" Video Calls Between Two Standards-based Organizations (B2B)

Named Federation: means to connect users from 'our' organization with users in a different, known organization. We know the target domain and the type of edge technology in use. In this document, we use the value *ciscob2b.com* to indicate a Cisco-based organization.

This option enables voice, video, and content calls between on-premises Cisco collaboration users and Cisco collaboration users in a different, known domain.

Note: Although this scenario does not use a Cisco Meeting Server, you could add one for conferencing (see [Audio/Video Meetings in Meeting Server Spaces, page 43](#)).

Figure 1 Outbound Call Signaling

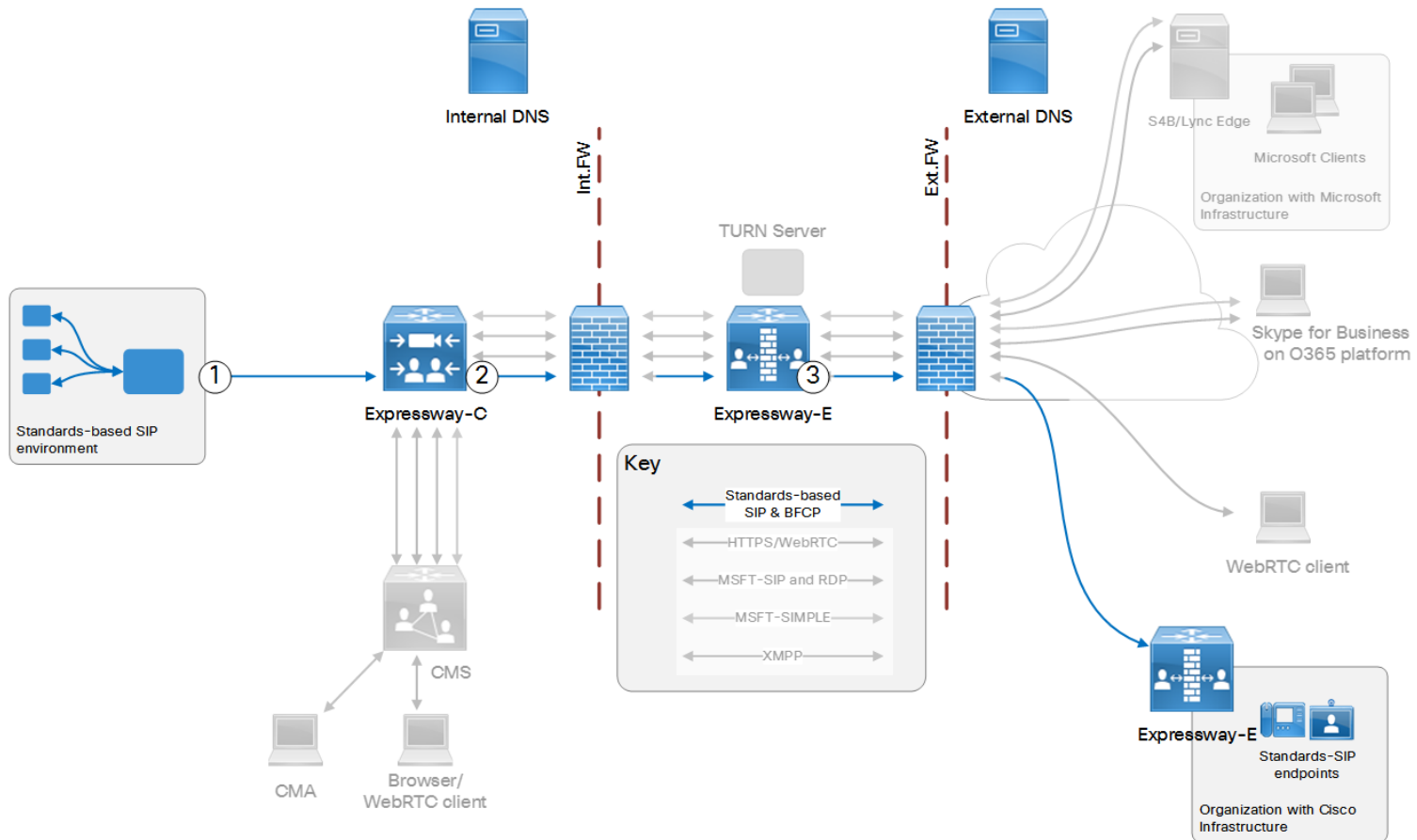

Table 3 Sample Outbound Dial Plan Rules

Arrow #	Rule Hosted On	Rule Order/Priority	From	Pattern and Logic	To
1	SIP registrar		Locally-registered endpoints	Route pattern <i>@ciscob2b.com</i> If the registrar is an Expressway or VCS, then On successful match Stop .	Trunk/neighbor zone to Expressway-C
2	Expressway-C		Any zone	Match alias pattern <i>.*@ciscob2b .com</i> On successful match Stop	Traversal client zone
3	Expressway-E		Traversal server zone	Match alias pattern <i>.*@ciscob2b .com</i> On successful match Stop	DNS zone

Figure 2 Inbound Call Signaling

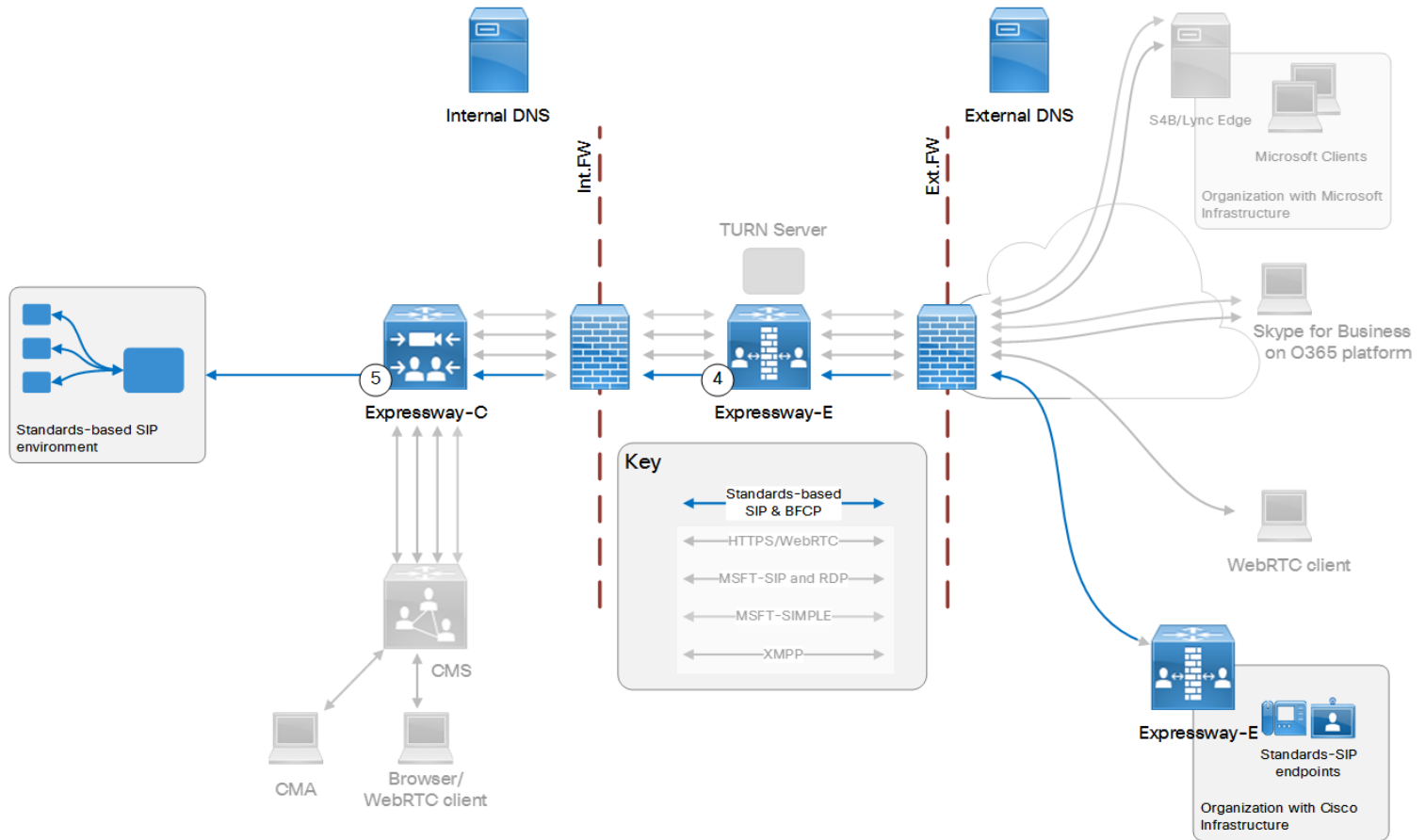

Table 4 Sample Dial Plan Rules for Inbound Call Flow

Arrow #	Rule Hosted	Rule Order/Priority	From	Pattern and Logic	To
4	Expressway-E		Default zone	Standards-based SIP variant, and alias pattern <i>.*@ciscoexample\.com</i> On successful match Stop	Traversal server zone
5	Expressway-C		Traversal client zone	Standards-based SIP variant, and alias pattern <i>.*@ciscoexample\.com</i> On successful match Stop	Zone to standards-based SIP registrar

Technical Overview of Named B2B Federation

This option does not require Cisco Meeting Server.

You do not need to enable the TURN server on Cisco Expressway-E.

Coexistence with Mobile and Remote Access

If you have B2B federation to Unified CM as well as Mobile and Remote Access (MRA), you must configure the SIP trunk profile to listen on a different port. Unified CM listens on (TCP/TLS) 5060/5061 for line-side communications from MRA endpoints. The trunk you use for B2B traffic must listen on a different TCP or TLS port.

B2B Configuration Summary

- [Core Configuration, page 19](#) except no TURN server or Meeting Server tasks, and Meeting Server is optional.
- Expressway-E: Create a DNS zone on Expressway-E. (**Configuration > Zones > Zones** with type = *DNS*)
- Expressway-C: Create a neighbor zone from Expressway-C to the on-premises SIP registrar. (**Configuration > Zones > Zones** with type = *Neighbor*)
- SIP registrar: Trunk/neighbor from the on-premises SIP registrar to Expressway-C.
If the registrar is Unified CM, see *Cisco Expressway SIP Trunk to Unified CM Deployment Guide* on the [Expressway configuration guides page](#).
If you're using the Expressway-C as a registrar as well as for federation, then this step is not required.
- Create domain-based search rules and a dial plan.

Dial Plan Description

1. CUCM / SIP registrar: Route calls addressed to the federated domain to the Expressway-C.
CUCM example: create a route pattern for the *ciscob2b.com* domain.
2. Expressway-C: Route any calls from the registrar neighbor zone, for pattern **@ciscob2b|.com*. To the traversal client zone.
3. Expressway-E: Route any calls from the traversal server zone, for pattern **@ciscob2b|.com*. To the DNS zone.
4. Expressway-E: Route any calls from the default zone, for pattern **@ciscoexample|.com*. To the traversal server zone.
5. Expressway-C: Route any calls from the traversal client zone, for pattern **@ciscoexample|.com*. To the registrar neighbor zone.

"Named Federation" Video Calls Between Cisco-based and Microsoft-based Organizations

Named Federation: means to connect users from 'our' organization with users in a different, known organization. We know the target domain. In this document, we use the value *msexample.com* to indicate a Microsoft-based organization, and *ciscob2b.com* for a Cisco-based organization.

This option enables voice, video, and content calls between on-premises Cisco collaboration users and Microsoft client users in a different, known domain.

Figure 3 Outbound Call Signaling

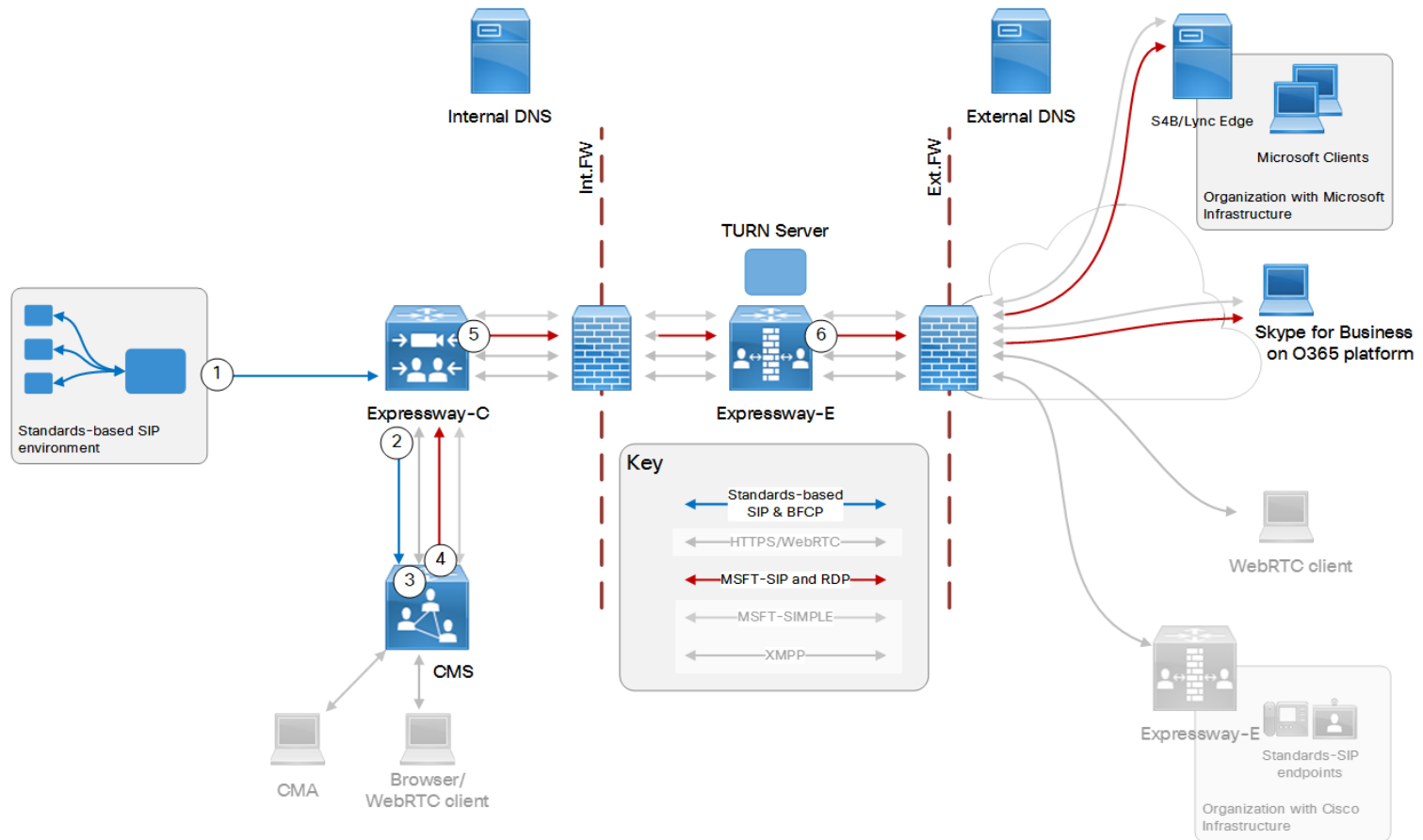

Table 5 Sample Dial Plan Rules for Outbound Callflow

Arrow #	Rule Hosted On	Rule Order/Priority	From	Pattern and Logic	To
1	Registrar		Locally-registered endpoints	Route pattern <i>*@msexample.com</i>	Trunk to Expressway-C
2	Expressway-C		Registrar zone	Standards-based SIP variant, for <i>.*@msexample.com</i> On successful match Stop	Meeting Server zone
3	Meeting Server		Expressway-C	Incoming calls for <i>msexample.com</i>	Forward (not terminate)
4	Meeting Server		Meeting Server	Outbound calls for <i>msexample.com</i> on Lync type trunk	Expressway-C
5	Expressway-C		Meeting Server zone	Microsoft AV & Share SIP variant, for <i>.*@msexample.com</i> On successful match Stop	Traversal client / UC zone
6	Expressway-E		Traversal server / UC zone	Microsoft AV & Share SIP variant, for <i>.*@msexample.com</i> On successful match Stop	DNS zone

Figure 4 Inbound Call Signaling

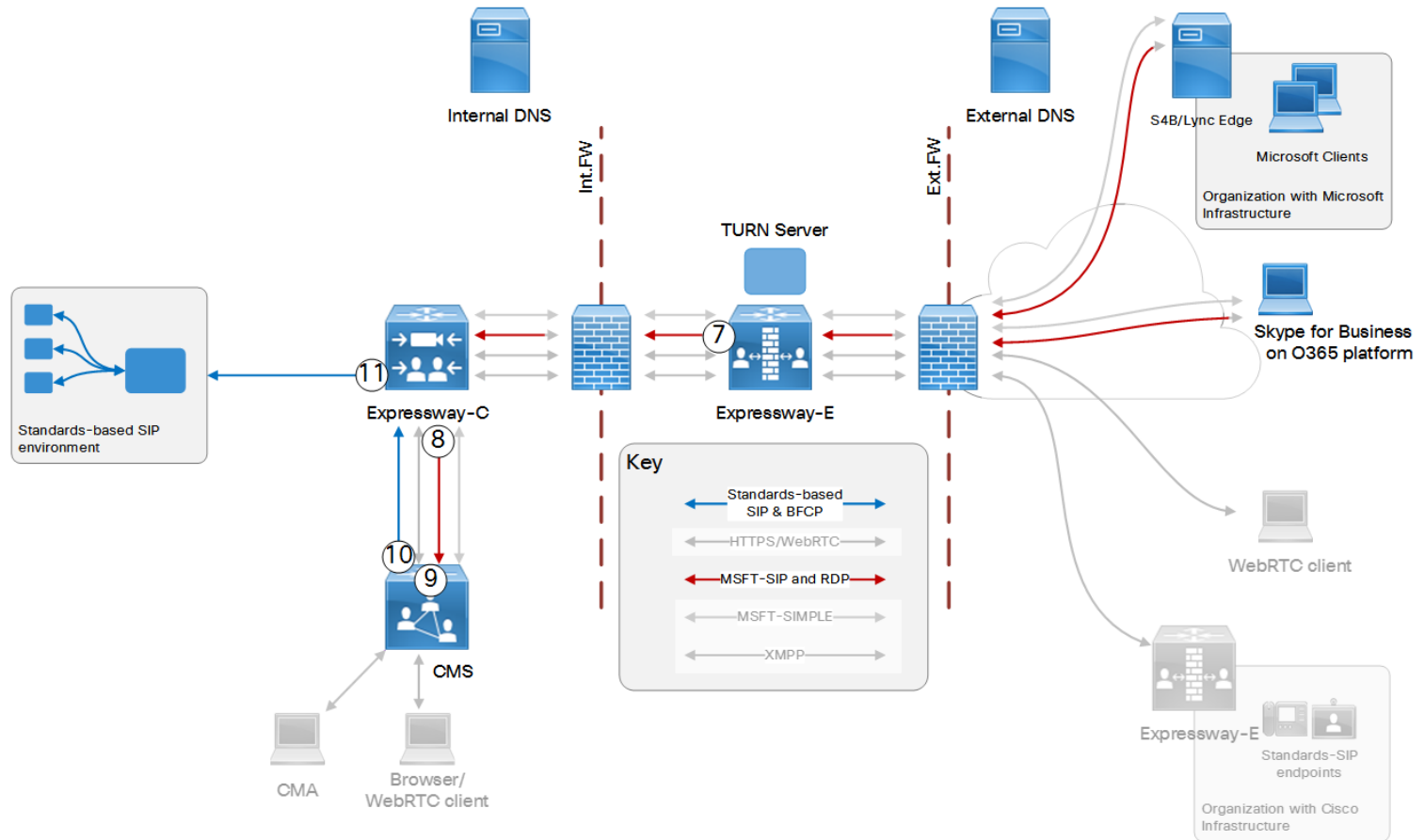

Table 6 Sample Dial Plan Rules for Inbound Callflow

Arrow #	Rule Hosted On	Rule Order/Priority	From	Pattern and Logic	To
7	Expressway-E		Default zone	Microsoft AV & Share SIP variant, for <i>.*@ciscoexample.com</i>	Traversal server / UC zone

Table 6 Sample Dial Plan Rules for Inbound Callflow (continued)

Arrow #	Rule Hosted On	Rule Order/Priority	From	Pattern and Logic	To
8	Expressway-C		Traversal client / UC zone	Microsoft AV & Share SIP variant, for . <i>*@ciscoexample.com</i>	Meeting Server zone
9	Meeting Server		Expressway-C	Incoming calls for <i>ciscoexample.com</i>	Forward (not terminate)
10	Meeting Server		Meeting Server	Outbound calls for <i>ciscoexample.com</i> on Standard SIP type trunk	Expressway-C
11	Expressway-C		Meeting Server zone	Standards-based SIP variant, for . <i>*@ciscoexample.com</i>	Registrar zone

Technical Overview of Named Federation

We are using the Cisco Meeting Server to adapt the traffic from standards-based SIP to Microsoft SIP, and from Microsoft SIP to standards-based SIP.

Coexistence

If you neighbor to Unified CM and also have Mobile and Remote Access (MRA) to that Unified CM, create new neighbor zones. You can't reuse the autogenerated MRA neighbor zones.

If you use MRA with federation, you need a distinct trunk from Unified CM to the Expressway-C. The trunk must listen on a different SIP port than the port that Unified CM listens on for MRA (line-side).

Named Federation Configuration Summary

- [Core Configuration, page 19](#)
- Expressway-C: Create a neighbor zone from Expressway-C to the on-premises SIP registrar. (**Configuration > Zones > Zones** with type = *Neighbor*)
- Registrar: Trunk the registrar to Expressway-C. (If Unified CM is the registrar, see *Cisco Expressway SIP Trunk to Unified CM Deployment Guide* on the [Expressway configuration guides page](#).)
- Expressway-E: Create a DNS zone on Expressway-E (**Configuration > Zones > Zones** with type = *DNS*).
- Expressway-E: Enable the TURN server on Expressway-E. (**Configuration > Traversal > TURN**)
- External DNS server: Verify a DNS SRV record on the external DNS to resolve `_sipfederationtls._tcp.msexample.com` to the Lync/Skype for Business Edge Server of the named organization.
This is outside of your control, but is required for federation.
- External DNS server: Define a DNS SRV record on the external DNS to resolve `_sipfederationtls._tcp.ciscoexample.com` to your Expressway-E public FQDN.
- Configure the dial plan across the infrastructure components.

Dial Plan Description

- Registrar: Create a routing rule on the registrar. To route calls addressed to `msexample.com` on the trunk to Expressway-C. For example, create a route pattern **Call Routing > SIP Route Pattern** if Unified CM is the registrar.
- Expressway-C:
 - a. Create a search rule on Expressway-C. To listen on the Meeting Server neighbor zone for Microsoft SIP calls destined for `.*@msexample.com`, and route them to the traversal client zone.
 - b. Create a search rule on Expressway-C. To route "Standard SIP" calls for `.*@msexample.com` from the registrar neighbor zone to the Meeting Server neighbor zone. (**Configuration > Dial plan > Search rules**)
 - c. Create a search rule on Expressway-C. To listen on the traversal client zone for Microsoft SIP calls destined for `.*@ciscoexample.com`, and route them to the Meeting Server neighbor zone.
 - d. Create a search rule on Expressway-C. To listen on the Meeting Server neighbor zone for standard SIP calls destined for `.*@ciscoexample.com`, and route them to the registrar neighbor zone.

Modular Deployment Options

- Meeting Server:
 - a. Create a dial plan rule on Meeting Server for incoming calls. To forward *msexample.com* calls instead of terminating them on Meeting Server. (**Configuration > Incoming calls**)
 - b. Create a dial plan rule on Meeting Server for outbound calls. With Expressway-C as the SIP proxy, trunk type Lync, and domain *msexample.com*. (**Configuration > Outbound calls**)
Now the Meeting Server will act as a gateway, and adapt inbound standards-based SIP to outbound Microsoft SIP.
 - c. Create a dial plan rule on Meeting Server for incoming calls. To forward *ciscoexample.com* calls instead of terminating them on Meeting Server. (**Configuration > Incoming calls**)
 - d. Create a dial plan rule on Meeting Server for outbound calls. With Expressway-C as the SIP proxy, trunk type Standard, and domain *ciscoexample.com*. (**Configuration > Outbound calls**)
Now the Meeting Server will adapt inbound Microsoft-variant SIP to outbound standard SIP.
- Cisco Expressway-E:
 - a. Create a search rule on Expressway-E. To listen on the traversal server zone for Microsoft SIP calls destined for **@msexample.com*, and route them to the DNS zone.
 - b. Create a search rule on Expressway-E. To listen on the default zone for Microsoft SIP calls destined for **@ciscoexample.com*, and route them to the traversal server zone.

"Open Federation" Video Calls With Microsoft Clients in External Domains

Open Federation: means connecting users from 'our' organization with users from other organizations whose domains we do not know in advance.

This option enables users in our organization to call users in any external domain that has registered the appropriate SRV records in the external DNS. This option uses the Expressway-E ability to do different SRV lookups, depending on the SIP variant.

Figure 5 Outbound Call Signaling

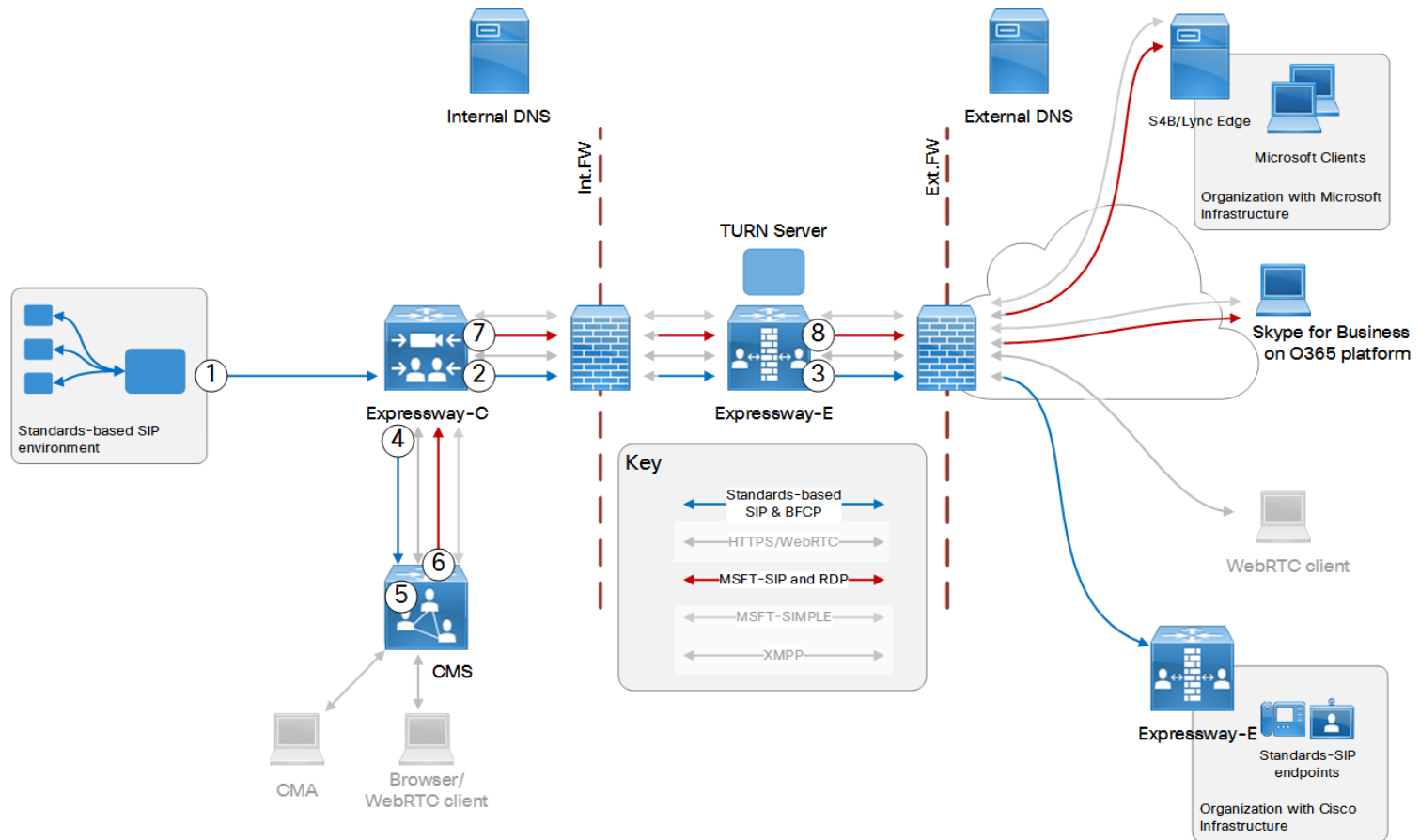

Table 7 Sample Dial Plan Rules for Outbound Callflow

Arrow #	Rule Hosted On	Rule Order/Priority	From	Pattern and Logic	To
1	Unified CM	Lower priority than anything recognized as a local domain	Endpoints registered to Unified CM	Route anything for non-internal domains outwards	Trunk to Expressway-C
2	Expressway-C	Lower priority than anything recognized as a local domain	Unified CM zone	Standards-based SIP variant, for any non-internal domains. On successful match <i>Continue</i>	Traversal client zone
3	Expressway-E		Traversal server zone	All SIP variants, any alias. If a matching service record is not found, Expressway-C uses its next search rule. On successful match <i>Stop</i>	DNS zone
4	Expressway-C	Lower priority than rule related to arrow number 2	Unified CM zone	Standards-based SIP variant, for any non-internal domains. On successful match <i>Stop</i>	Meeting Server zone
5	Meeting Server	Lower priority than any incoming rules for known domains	Expressway-C	Incoming calls for unknown domains	Forward (not terminate)
6	Meeting Server		Meeting Server	Outbound calls for unknown domains on Lync type trunk	Expressway-C
7	Expressway-C		Meeting Server zone	Microsoft AV & Share SIP variant, for unknown domains On successful match <i>Stop</i>	Traversal client zone
8	Expressway-E		Traversal server zone	Microsoft AV & Share SIP variant, for unknown domains. On successful match <i>Stop</i>	DNS zone

Figure 6 Inbound Call Signaling

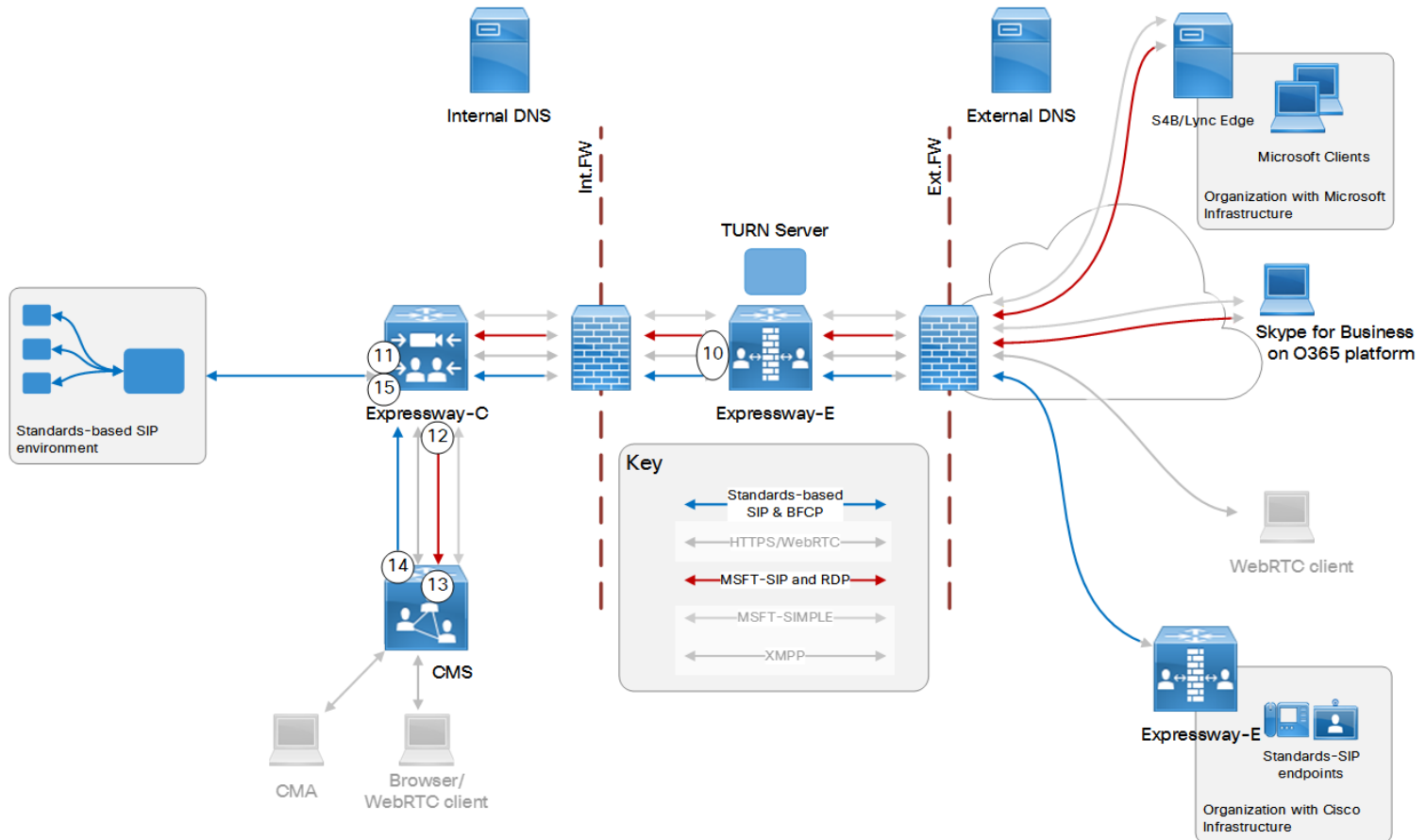

Table 8 Sample Dial Plan Rules for Inbound Callflow

Arrow #	Rule Hosted On	Rule Order/Priority	From	Pattern and Logic	To
10	Expressway-E		Default zone	Any SIP variant, and alias pattern <i>.*@ciscoexample.com</i> On successful match Stop	Traversal server zone

Table 8 Sample Dial Plan Rules for Inbound Callflow (continued)

Arrow #	Rule Hosted On	Rule Order/Priority	From	Pattern and Logic	To
11	Expressway-C		Traversal client zone	Standards-based SIP variant, and alias pattern . <i>*@ciscoexample.com</i> On successful match Stop	Unified CM zone
12	Expressway-C		Traversal client zone	Microsoft AV and Share SIP variant, and alias pattern . <i>*@ciscoexample.com</i> On successful match Stop	Meeting Server zone
13	Meeting Server		Expressway-C	Incoming calls for <i>ciscoexample.com</i>	Forward (not terminate)
14	Meeting Server		Meeting Server	Outbound calls for <i>ciscoexample.com</i> on Standard SIP type trunk	Expressway-C
15	Expressway-C		Meeting Server zone	Standards-based SIP variant, for . <i>*@ciscoexample.com</i> On successful match Stop	Unified CM zone

Modular Deployment Options

Open Federation Technical Overview

The dial plan here assumes that the outbound calls are towards other standards-based organizations. (Call flow following arrows 1, 2, 3 on the diagram.)

However, the call will probably fail if the dialed URI is not in a standards-based organization. The DNS lookup will fail because the external domain will not have published a standard SIP federation record (`_sip._tcp.example.com` or `_sips._tcp.example.com`). The organization may have published a Microsoft proprietary SIP federation service record in the DNS instead (`_sipfederationtls._tcp.example.com`).

If the initial attempt fails, we want to try again but using the Microsoft variant SIP. When you create the rule (2) we recommend that you allow it to *Continue* searching, so that it tries a lower priority rule to send the call to Meeting Server to route the call out as a *Lync* type. (Call flow following arrows 1, 4, 5, 6, 7, 8 on the diagram.)

Open Federation Configuration Summary

- [Core Configuration, page 19](#)
 - Expressway-C: Create a neighbor zone from Expressway-C to the on-premises SIP registrar. (**Configuration > Zones > Zones** with type = *Neighbor*)

If you neighbor to Unified CM and also have Mobile and Remote Access (MRA) to that Unified CM, create new neighbor zones. You can't reuse the autogenerated MRA neighbor zones.
 - Registrar: Trunk the registrar to Expressway-C. (If Unified CM is the registrar, see *Cisco Expressway SIP Trunk to Unified CM Deployment Guide* on the [Expressway configuration guides page](#).)

If you use MRA with federation, you need a distinct trunk from Unified CM to the Expressway-C. The trunk must listen on a different SIP port than the port that Unified CM listens on for MRA (line-side).
 - Expressway-E: Create a DNS zone on Expressway-E (**Configuration > Zones > Zones** with type = *DNS*).
 - Expressway-E: Enable the TURN server on Expressway-E. (**Configuration > Traversal > TURN**)
 - External DNS server: On the external DNS, verify DNS SRV federation records which resolve to called destination domains (this is outside of your control, but needs to be there for the call to work).
 - External DNS server: Define a DNS SRV record on the external DNS to resolve `_sipfederationtls._tcp.ciscoexample.com` to your Expressway-E public FQDN.
- Note:** The federation DNS SRV record and target are subject to some limitations, particularly with respect to load balancing and DNS namespace. See [External DNS Records, page 70](#).
- Create dial plan.

Dial Plan Description

- Registrar: Create a route pattern on the registrar. To route all non-local calls on the trunk to Expressway-C. (**Call Routing > SIP Route Pattern** if Unified CM is the registrar)

Modular Deployment Options

- Expressway-C:
 - a. Create a search rule on Expressway-C. To route all calls for non-local domains to the traversal client zone. **(Configuration > Dial plan > Search rules)**

The search rule must be set to continue searching, as the call may fail if the DNS lookup is performed against the wrong SRV record of the federated organization. That is, a Microsoft-based organization would answer to `_sipfederationtls._tcp` lookup; a standards-based organization would answer to a `_sip._tcp` or `_sips._tcp` lookup.
 - b. Create a secondary search rule, lower priority than rule *a.*, on Expressway-C. To route all calls for non-local domains to the Meeting Server neighbor zone. **(Configuration > Dial plan > Search rules)**

The call could fail after being routed as in rule *a.*, so this rule tries routing it through the Meeting Server where it is adapted into Microsoft variant SIP.
 - c. Create a search rule on Expressway-C. To listen on the Meeting Server neighbor zone for Microsoft SIP calls and route them to the traversal client zone.
 - d. Create a search rule on Expressway-C. To listen on the traversal client zone for Microsoft SIP calls destined for `.*@ciscoexample.com`, and route them to the Meeting Server neighbor zone.
 - e. Create a search rule on Expressway-C. To listen on Any zone for standard SIP calls destined for `.*@ciscoexample.com`, and route them to the registrar neighbor zone.
- Meeting Server:
 - a. Create a dial plan rule on Meeting Server for incoming calls. To forward calls for non-local domains instead of terminating them on Meeting Server. **(Configuration > Incoming calls)**
 - b. Create a dial plan rule on Meeting Server for outbound calls. With Expressway-C as the SIP proxy, and trunk type as Lync. **(Configuration > Outbound calls)**

Now the Meeting Server will act as a gateway, and adapt inbound standards-based SIP to outbound Microsoft SIP.
 - c. Create a dial plan rule on Meeting Server for incoming calls. To forward `ciscoexample.com` calls instead of terminating them on Meeting Server. **(Configuration > Incoming calls)**
 - d. Create a dial plan rule on Meeting Server for outbound calls. With Expressway-C as the SIP proxy, trunk type Standard, and domain `ciscoexample.com`. **(Configuration > Outbound calls)**

Now the Meeting Server will adapt the inbound Microsoft-variant SIP, to outbound standard SIP.
- Expressway-E:
 - a. Create a search rule to listen on the default zone for calls destined for `.*@ciscoexample.com`, and route them to the traversal server zone.
 - b. Create a rule to listen on the traversal server zone for SIP calls to non-local domains, and route them to the DNS zone.

Audio/Video Meetings in Meeting Server Spaces

This option combines Expressway as a registrar with the Meeting Server edge functionality. So enterprises with traditional VoIP environments can adopt video, and collaborate with organizations which use Skype for Business.

You can use Unified CM in place of the generic SIP registrar shown in the diagram. You do not have to trunk Unified CM directly to Meeting Server, but if you want to do that, see [High Scale Calls and Meetings with Unified CM and Meeting Server, page 50](#).

Also, you are not required to register video endpoints to the Expressway-C, but that is an option if your SIP agent does not support these types of systems.

We recommend using a subdomain for your conferences because some call agents cannot make routing decisions based on the username part of the requested URI. For example, we suggest that you use the form `user1.space@cms.ciscoexample.com` in your dial plan instead of `user1.space@ciscoexample.com`.

Figure 7 Call Routing

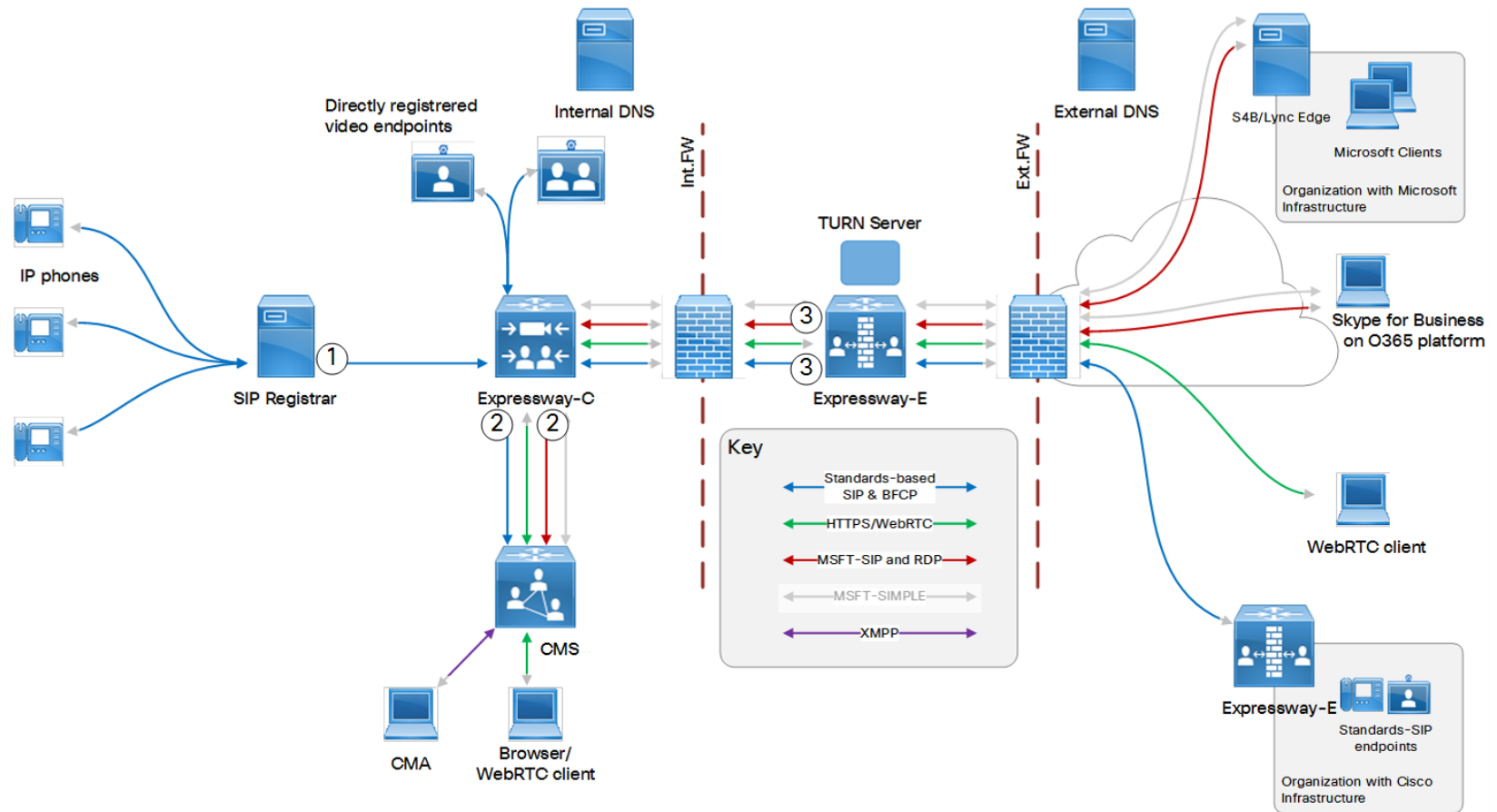

Table 9 Sample Dial Plan Rules

Arrow #	Rule Hosted On	Rule Order/Priority	From	Pattern and Logic	To
1	SIP registrar		Locally registered endpoints	For <i>@cms.ciscoexample.com</i> If the registrar is an Expressway or VCS, then On successful match Stop .	Expressway-C trunk
2	Expressway-C		Any	All SIP variants, for <i>.*@cms\.ciscoexample\.com</i> On successful match Stop	Meeting Server zone
3	Expressway-E		Default zone	All SIP variants, for <i>.*@cms\.ciscoexample\.com</i> On successful match Stop	Traversal server zone

Modular Deployment Options

Technical Overview

This option shows generic call control for the standards-based portion of the video deployment. The sample dial plan is also valid if you use Cisco Unified Communications Manager for call control.

If you want to take advantage of Unified CM call management features like bandwidth control, you should route all calls to Unified CM. See [High Scale Calls and Meetings with Unified CM and Meeting Server, page 50](#).

Configuration Summary

1. [Core Configuration, page 19](#) for zones, trunks, and TURN.
2. Meeting Server: Create spaces on Meeting Server, following the pattern `username.space@cms.ciscoexample.com`. (**Configuration > Spaces**)
3. [Optional] Enable Meeting Server Web Proxy. See [Web Proxy for Meeting Server Configuration Summary, page 65](#).

Dial Plan Description

- SIP registrar: Create a dial plan rule to route calls matching `cms.ciscoexample.com` on the trunk to Expressway-C.
For example, on Unified CM, **Call Routing > SIP Route Pattern**.
- Expressway-C: Create a search rule on Expressway-C. To route "All SIP" variants for calls matching `.*@cms\.ciscoexample\.com`, to the Meeting Server neighbor zone. (**Configuration > Dial plan > Search rules**).
- Expressway-E: Create a search rule on Expressway-E. To route "All SIP" variants for calls matching `.*@cms\.ciscoexample\.com`, from the default zone to the traversal server zone. (**Configuration > Dial plan > Search rules**).
- Meeting Server: Create an inbound dial plan rule for calls that Match the pattern `*@cms.ciscoexample.com`, and terminates them in spaces. (**Configuration > Incoming calls**).

Meeting Server Calling Out

This option enables Meeting Server to call out to users in other organizations that have published their audio/video federation addresses. So that our users can invite external participants to join Meeting Server spaces.

Figure 8 Outbound Callflows From Meeting Server Spaces

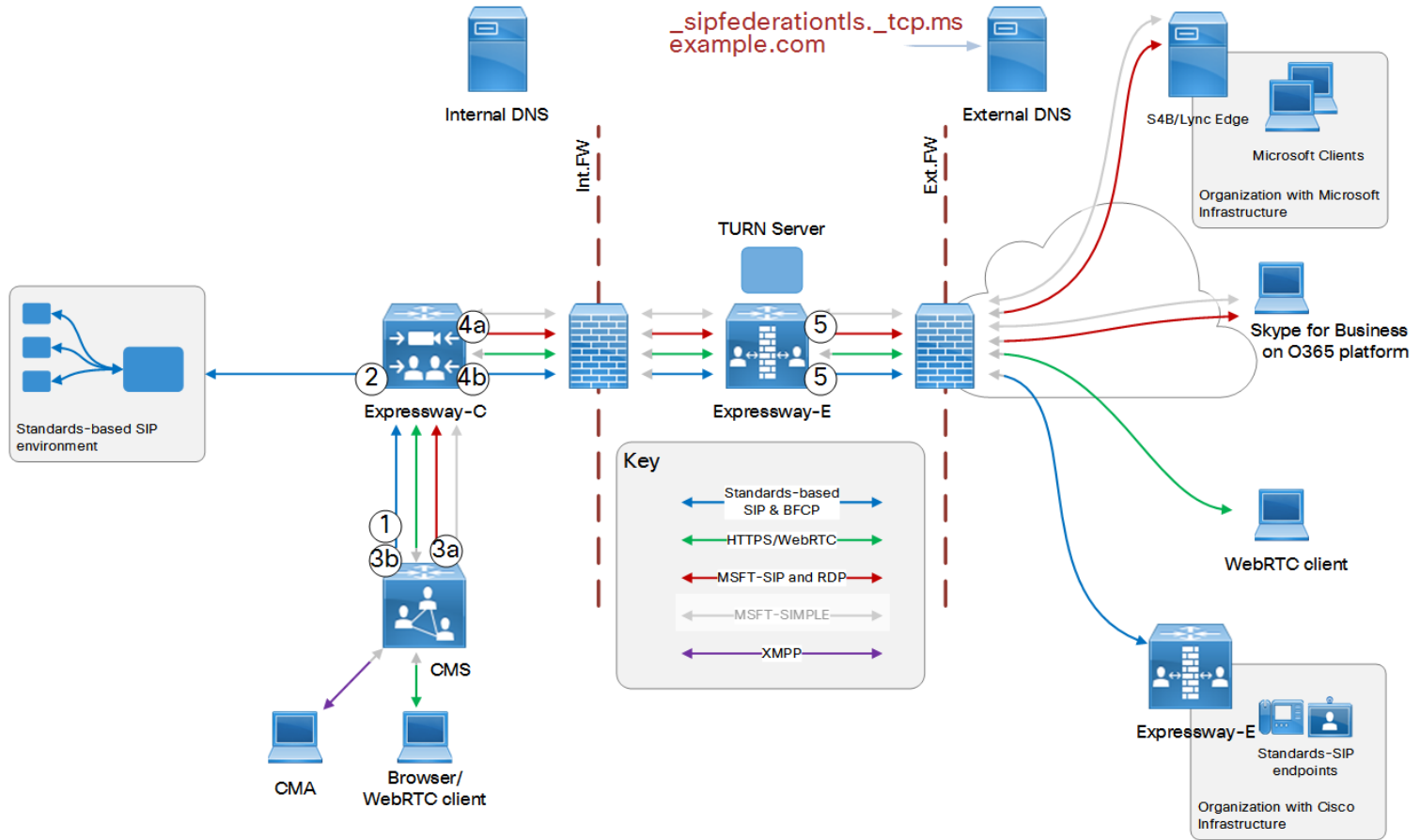

Table 10 Sample Dial Plan Rules for Outbound Calls

Arrow #	Rule Hosted On	Rule Order/Priority	From	Pattern and Logic	To
1	Meeting Server	Higher priority than all rules to unknown domains.	Meeting Server space	Outbound configuration for <i>ciscoexample.com</i> to Standards type trunk. Set the rule to <i>Stop</i> if matched.	Expressway-C
2	Expressway-C	Higher priority than all rules for unknown domains.	Meeting Server neighbor zone	Standards-based SIP, for <i>.*@ciscoexample.com</i> . On successful match Stop	Neighbor zone to SIP registrar
3a	Meeting Server	Higher priority (lower priority number) than rule related to call flow arrow 3b.	Meeting Server space	Outbound configuration for any pattern not locally known to Lync type trunk. Set the rule to <i>Continue</i> if matched.	Expressway-C
3b	Meeting Server	Lower priority (higher priority number) than rule related to call flow arrow 3a.	Meeting Server space	Outbound configuration for any pattern not locally known to Standards type trunk. Set the rule to <i>Stop</i> if matched.	Expressway-C
4a	Expressway-C	Higher priority (lower priority number on UI) than rule relating to call flow arrow 4b. Set the rule to continue, in case the first DNS lookup fails because the external domain does not have a Microsoft federation record.	Meeting Server neighbor zone	Microsoft AV & Share type, for any destination that does not match <i>.*@ciscoexample.com</i> (or other well-known registrar domains). On successful match Stop	Traversal client zone
4b	Expressway-C		Meeting Server neighbor zone	Standards-based SIP, for any destination that does not match <i>.*@ciscoexample.com</i> (or other well-known registrar domains). On successful match Stop	Traversal client zone
5	Expressway-E		Traversal server zone	All SIP variants, for any destination. On successful match Stop .	DNS zone

Modular Deployment Options

Technical Overview

This option enables Meeting Server to call out to users in other organizations that have published their audio/video federation addresses. So that users can invite external participants to join Meeting Server spaces.

Dial Plan Concepts

The dial plan here assumes that the outbound trunk from Meeting Server should be *Lync* type for the first attempt at an outbound call for an unknown domain. (Call flow 3a, 4a, 5 on the diagram.)

However, the call will probably fail if the dialed URI is not in a Microsoft-based organization. The DNS lookup will fail because the external domain will not have published the Service Record used by Microsoft for SIP federation (`_sipfederationtls._tcp.example.com`). The organization may have published a standard SIP federation record in the DNS instead (`_sip._tcp.example.com`. Or `_sips._tcp.example.com`).

So when you create a rule on Meeting Server, to route outbound calls as *Lync* type, we recommend that the rule *continues* searching if the call is not placed. Then Meeting Server will try the lower priority rule that routes the call out as a Standards-based SIP call. (Call flow 3b, 4b, 5 on the diagram.)

If you know that some specific domains are of standards-based organizations, then you could add specific rules for those domains. You could set the rules with higher priority than 3a and 3b and send the calls out as Standard type.

Configuration Summary

1. [Core Configuration, page 19](#) for zones, trunks, and TURN.
2. Expressway-E: Create a DNS zone on Expressway-E (**Configuration > Zones > Zones** with type = *DNS*).

Dial Plan Description

- Meeting Server: Create search rules in this priority order:
 - a. Create outbound configuration on Meeting Server to route calls for `*@ciscoexample.com` to Expressway-C. Stop if matched.
 - b. Create outbound configuration on Meeting Server to route calls for unknown destinations to Expressway-C on *Lync* type trunk. Continue if matched.
 - c. Create outbound configuration on Meeting Server to route calls for unknown destinations to Expressway-C on *Standard* type trunk. Stop if matched.
- Expressway-C: Create search rules in this priority order:
 - a. Route Standards-based SIP for `.*@ciscoexample|.com` from the Meeting Server zone to the registrar zone. Stop if matched.
 - b. Route Microsoft AV & Share SIP variant for any alias from the Meeting Server zone to the traversal client zone. Stop if matched.
 - c. Route Standards-based SIP for any alias from the Meeting Server zone to the traversal client zone. Stop if matched.
- Expressway-E: Create a search rule to route All SIP Variants from the traversal server zone to the DNS zone.

High Scale Calls and Meetings with Unified CM and Meeting Server

This option uses a dedicated Meeting Server to transcode between different SIP variants, and a separate Meeting Server to host spaces.

The outbound configuration and call flows are discussed in other sections of the document. Here we are going to focus on making sure that inbound calls, and calls within the organization, are routed to the destination endpoint or space.

Figure 9 Traffic Routing

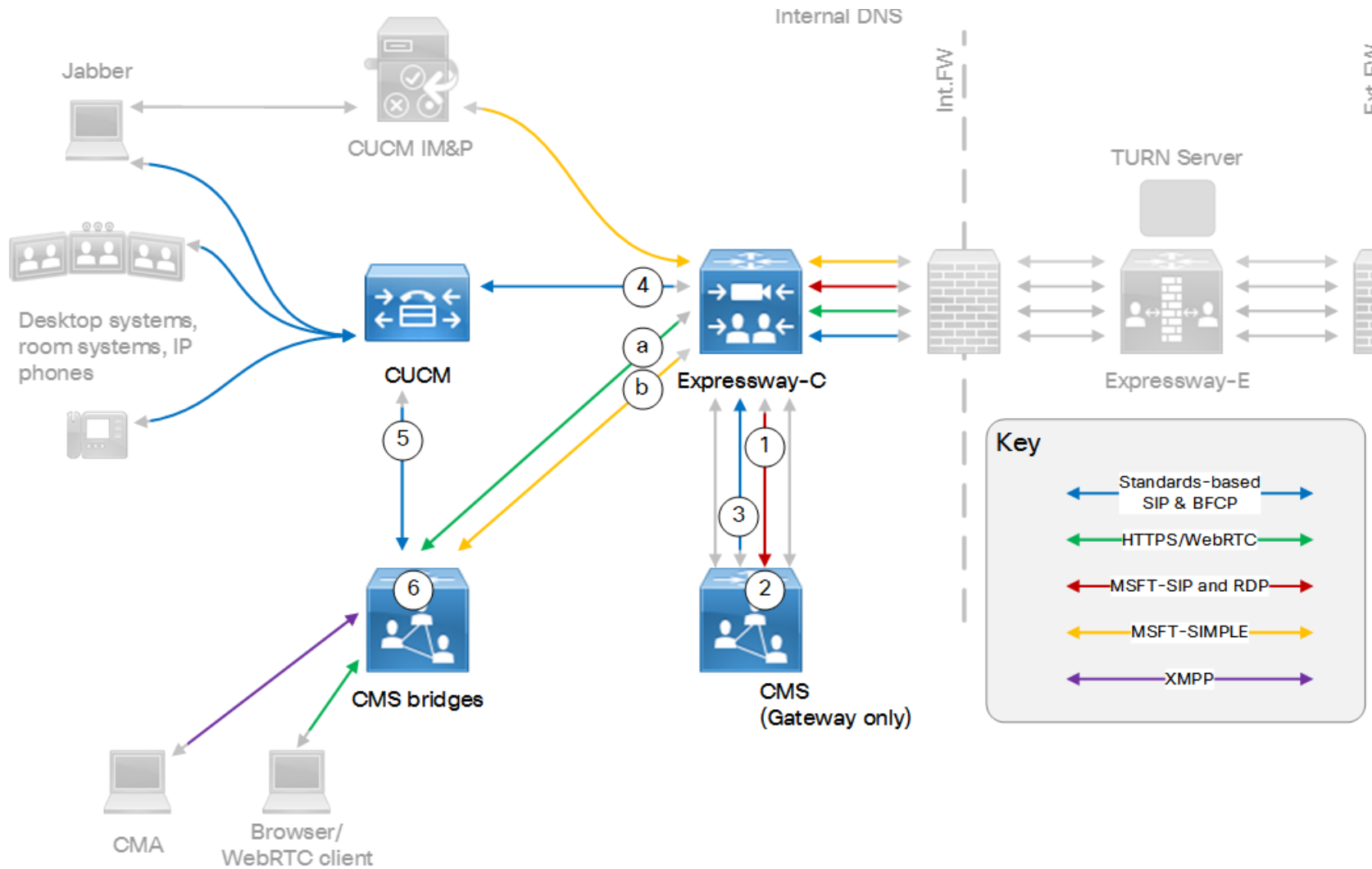

Table 11 Sample Dial Plan Rules

Arrow #	Rule Hosted On	Rule Order/Priority	From	Pattern and Logic	To
1	Expressway-C		Traversal client zone	Microsoft SIP, for <i>@cms.ciscoexample.com</i> On successful match Stop	Gateway Meeting Server zone
1	Expressway-C		Traversal client zone	Microsoft SIP, for <i>@ciscoexample.com</i> On successful match Stop	Gateway Meeting Server zone
2	Gateway Meeting Server		Expressway-C	Incoming calls for <i>@cms.ciscoexample.com</i>	Forward (not terminate)
2	Gateway Meeting Server		Expressway-C	Incoming calls for <i>@ciscoexample.com</i>	Forward (not terminate)
3	Gateway Meeting Server		Meeting Server	Outbound calls for <i>@cms.ciscoexample.com</i> on Standard SIP type trunk	Expressway-C
3	Gateway Meeting Server		Meeting Server	Outbound calls for <i>@ciscoexample.com</i> on Standard SIP type trunk	Expressway-C
4	Expressway-C		Any	Standards-based SIP, for <i>@ciscoexample.com</i> On successful match Stop You could combine the two rules for this arrow using a regex. Having two rules is arguably safer and easier to demonstrate / troubleshoot.	Unified CM zone
4	Expressway-C		Any	Standards-based SIP, for <i>@cms.ciscoexample.com</i> On successful match Stop	Unified CM zone
5	Unified CM		Expressway-C trunk or locally registered endpoints	For <i>@cms.ciscoexample.com</i>	Conferencing Meeting Server trunk
6	Conferencing Meeting Server		Inbound	Match <i>*@cms.ciscoexample.com</i>	Terminate in spaces

Table 11 Sample Dial Plan Rules (continued)

Arrow #	Rule Hosted On	Rule Order/Priority	From	Pattern and Logic	To
a	No rule required			Provide Expressway-C with the Guest account client URI from the web bridge settings on the conferencing Meeting Server	
b	Expressway-C		Any	Microsoft SIP IM&P for <code>cms.ciscoexample.com</code> On successful match Stop	Conferencing Meeting Server neighbor zone

Technical Overview of High Scale

Two Cisco Meeting Servers:

- A "gateway" Meeting Server. This one is dedicated to adapting from inbound Microsoft SIP variant, and to outbound Microsoft SIP variant.
- A "conferencing" Meeting Server. This one hosts spaces and web bridges with aliases
*.space@cms.ciscoexample.com

Gateway operations (transcoding) between different SIP variants is handled by a dedicated Meeting Server, which saves resources for conferencing on the other Meeting Server.

Arrow 1: Calls that come from external Microsoft clients and are addressed for spaces on the conferencing Meeting Server are first diverted to the gateway Meeting Server to be transcoded to standards-based SIP.

Number 2: Two rules on the gateway Meeting Server to forward inbound calls that are for `cms.ciscoexample.com` and `ciscoexample.com`.

Arrow 3: Two rules on the gateway Meeting Server to route outbound calls for `cms.ciscoexample.com` and `ciscoexample.com` on a standard SIP trunk to Expressway-C.

Arrow 4: Rules on Expressway-C to route calls for both domains `cms.ciscoexample.com` and `ciscoexample.com` to Unified CM.

You need to route standards-based SIP calls from both the traversal client zone and the gateway Meeting Server zone to the Unified CM neighbor zone. You could do it with one rule, but you might find it easier to implement and maintain if you use two or four.

Arrow 5: A route pattern on Unified CM to send calls for `cms.ciscoexample.com` to the conferencing Meeting Server.

Calls that come from internal standards-based clients and are addressed for external Microsoft clients are first diverted to the gateway Meeting Server to be transcoded to Microsoft-variant SIP.

Number 6: A rule on the conferencing Meeting Server to match calls for `cms.example.com` and terminate them in spaces.

Arrow a: If you want to have guests joining conferences, you can set up web bridges on the conferencing Meeting Server. In this case you do not need any search rules, but you need to configure the [Web Proxy for Cisco Meeting Server, page 62](#).

Arrow b: Routes Microsoft SIP IM&P towards spaces on the conferencing Meeting Server, enabling chat between Jabber and Microsoft clients. You need at least one search rule to route Microsoft SIP IM&P for `cms.ciscoexample.com`. You may find it easier to use two rules, if you have traffic from IM and Presence Service as well as from external Microsoft infrastructure .

High Scale Configuration Summary

1. [Core Configuration, page 19](#) for zones, trunks, and TURN.
2. Trunk Unified CM to the conferencing Meeting Server.
See *Cisco Meeting Server Deployments with Call Control* on the [Cisco Meeting Server configuration guides page](#).
3. Create spaces on the conferencing Meeting Server, following the pattern `username.space@cms.ciscoexample.com`. (**Configuration > Spaces**)
4. [Optional] Enable Web Proxy for Meeting Server to route inbound guest calls to the conferencing Meeting Server.
See [Web Proxy for Cisco Meeting Server, page 62](#).
5. Create the dial plan.

Modular Deployment Options

Dial Plan Description

- Unified CM:
 - Create a SIP route pattern on Unified CM to route destinations ending *cms.ciscoexample.com* on the trunk, to the conferencing Meeting Server. (**Call Routing > SIP Route Pattern**)
 - Create a route pattern on Unified CM to route destinations ending *msexample.com* on the trunk to the Expressway-C. (**Call Routing > SIP Route Pattern**)
- Conferencing Meeting Server: Create an inbound rule to terminate calls for *cms.ciscoexample.com* in spaces. (**Configuration > Incoming calls**)
- Expressway-C:
 - Create a search rule to route Microsoft AV & Share calls from the traversal client zone. For destinations matching *.*@ciscoexample.com*. To the gateway Meeting Server neighbor zone. (**Configuration > Dial plan > Search rules**)
 - Create a search rule to route Microsoft AV & Share calls from the traversal client zone. For destinations matching *.*@cms.ciscoexample.com*. To the gateway Meeting Server neighbor zone. (**Configuration > Dial plan > Search rules**)
 - Create a search rule on Expressway-C, to route Standards-based SIP from the Traversal Client zone. For destinations ending *.*@ciscoexample.com*. To the Unified CM neighbor zone. (**Configuration > Dial plan > Search rules**)
 - Create a search rule on Expressway-C, to route Standards-based SIP from the Traversal client zone. For destinations ending *.*@cms.ciscoexample.com*. To the Unified CM neighbor zone. (**Configuration > Dial plan > Search rules**)
- Gateway Meeting Server inbound rules (**Configuration > Incoming calls**):
 - Define an inbound rule to forward calls for *cms.ciscoexample.com* instead of terminating them on this Meeting Server.
 - Define an inbound rule to forward calls for *ciscoexample.com* instead of terminating them on the Meeting Server.
 - Define an inbound rule to forward calls for federated Microsoft-based domains *msexample.com* instead of terminating them on the Meeting Server.
- Gateway Meeting Server outbound rules (**Configuration > Outbound calls**):
 - Define an outbound rule to route calls for *ciscoexample.com* on the standards-based trunk, to the Expressway-C.
 - Define an outbound rule to route calls for *cms.ciscoexample.com* on the standards-based trunk, to the Expressway-C.
 - Define an outbound rule to route calls for *msexample.com* on the Lync-type trunk, to the Expressway-C.
- Expressway-E search rules (**Configuration > Dial plan > Search rules**):
 - Create a search rule to route calls for *.*@cms.ciscoexample.com* from the default zone to the traversal server zone.
 - Create a search rule to route calls for *.*@ciscoexample.com* from the default zone to the traversal server zone.
 - Create a search rule to route calls for *.*@msexample.com* from the traversal server zone to the DNS zone.

IM&P Federation With Microsoft-based Organizations

Note: This deployment option does not require Cisco Meeting Server.

Figure 10 Outbound Signaling

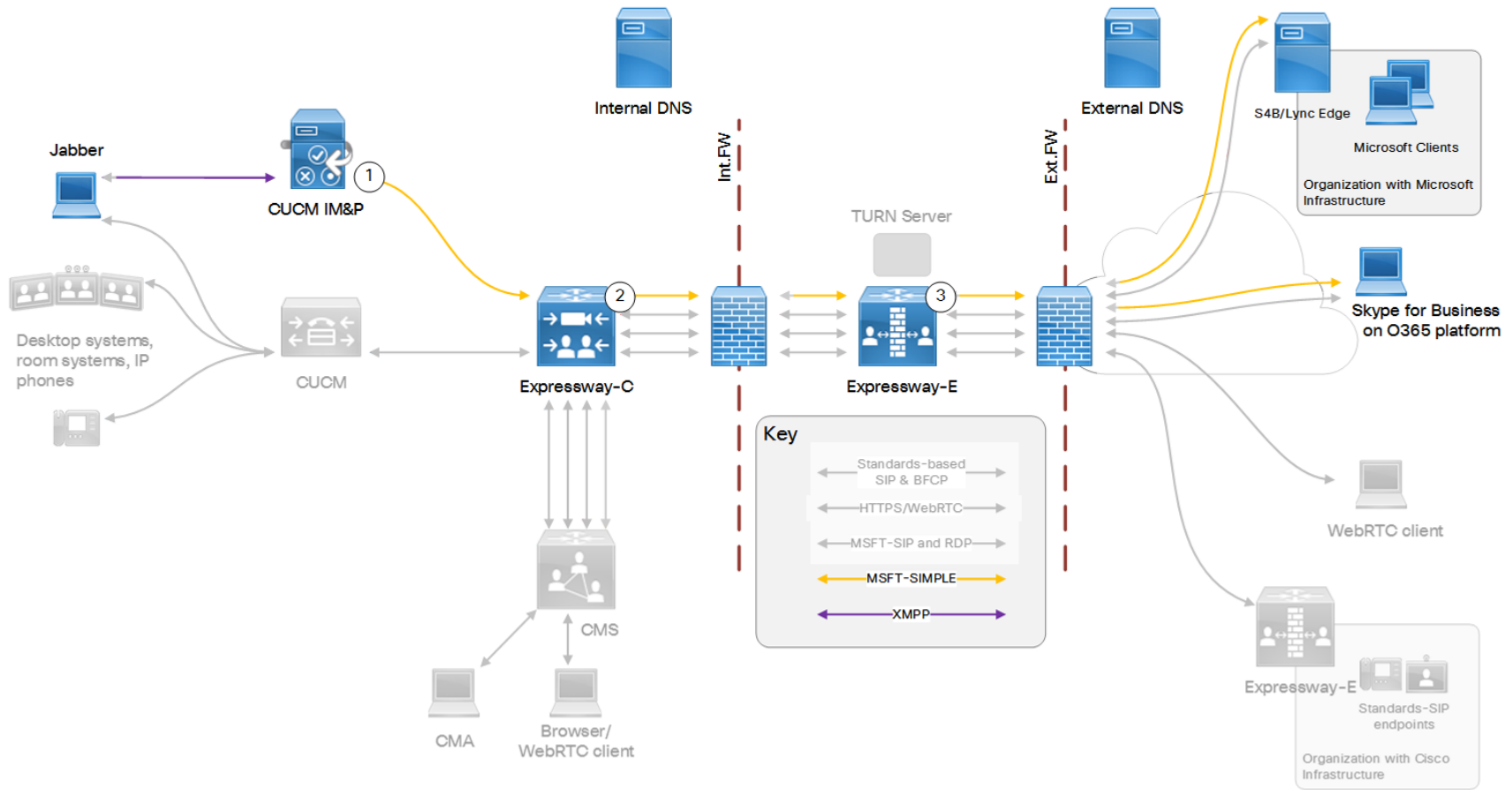

Table 12 Sample Outbound Dial Plan Rules

Arrow #	Rule Hosted On	Rule Order/Priority	From	Pattern and Logic	To
1	Cisco Unified Communications Manager IM and Presence Service		Jabber	*@msexample.com	Static route to Expressway-C
2	Expressway-C		IM&P neighbor zone	MS SIP IM&P for .*@msexample\com	Traversal client zone
3†	Expressway-E	Lowest priority rule = highest priority number	Traversal server zone	<i>All SIP Variants for Any alias</i>	DNS zone

† This rule is required because of the way we handle NOTIFY messages. See [Technical Overview, page 60](#).

Figure 11 Inbound Signaling

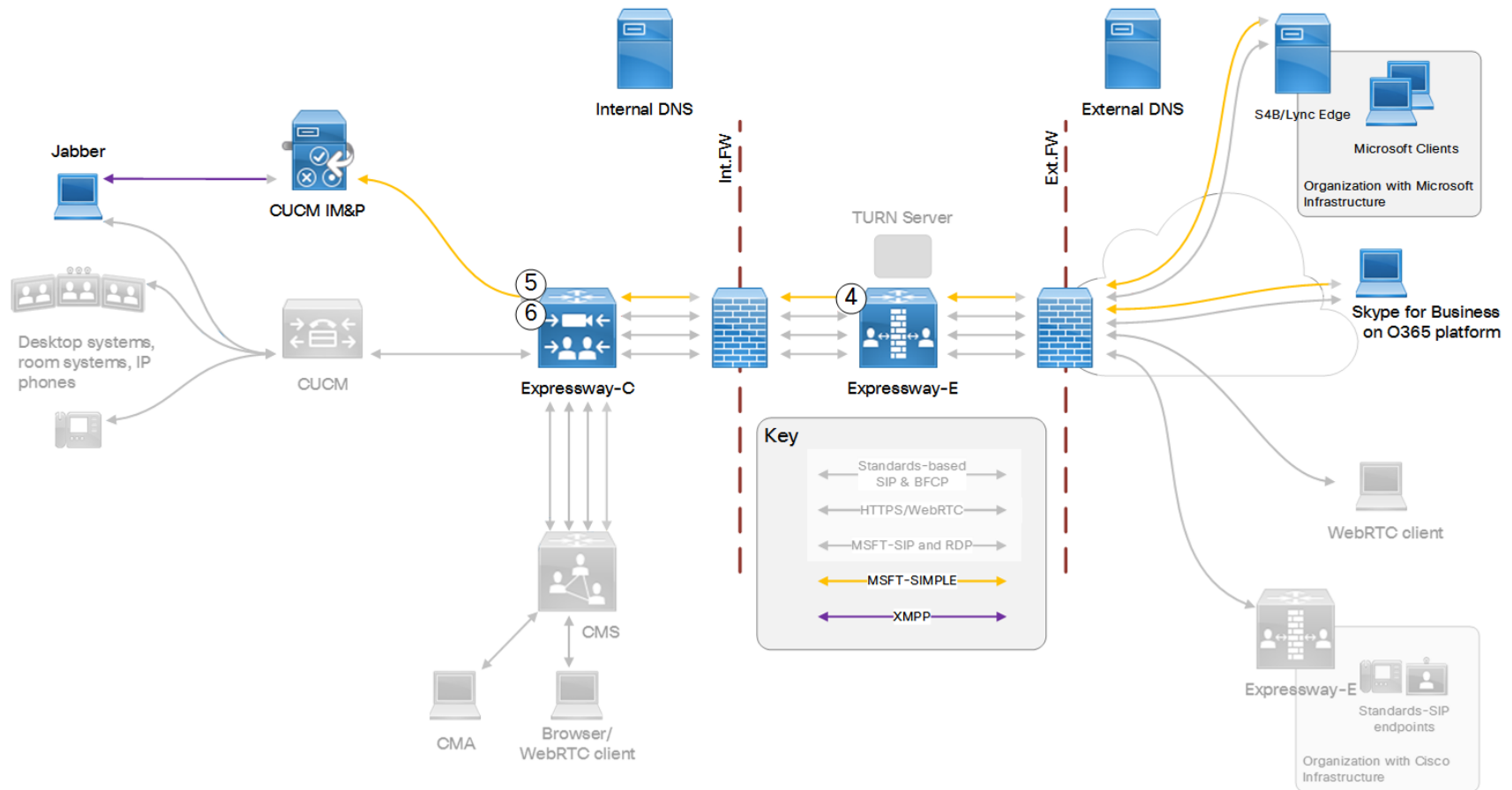

Table 13 Sample Inbound Dial Plan Rules

Arrow #	Rule Owner	Rule Order/Priority	From	Pattern and Logic	To
4	On Expressway-E		Default zone	MS SIP IM&P for .*@ciscoexample\com	Traversal server zone
5	On Expressway-C		Traversal client zone	MS SIP IM&P for .*@ciscoexample\com	IM&P neighbor zone

Table 13 Sample Inbound Dial Plan Rules (continued)

Arrow #	Rule Owner	Rule Order/Priority	From	Pattern and Logic	To
6*	On Expressway-C		Traversal client zone	MS SIP IM&P for <code>.*IMP1-public\.ciscoexample\.com.*</code> On successful match <i>Stop</i>	IM&P neighbor zone

* This rule is required because of the way we handle NOTIFY messages. See [Technical Overview, page 60](#).

Modular Deployment Options

Technical Overview

This federation is based on TLS throughout.

NOTIFY Messages

SUBSCRIBE messages are sent between clients to request presence status. Subsequent NOTIFY messages within the same dialog signal changes in presence. The NOTIFY messages should not need any special routing consideration because they are within the same dialog as the SUBSCRIBE and should follow the same route.

However, for performance reasons we have chosen not to hold information about SUBSCRIBE dialogs. This means we must use search rules to route the NOTIFY messages.

Another issue we have with NOTIFY messages is that we do not currently classify outbound NOTIFY from IM and Presence Service in the same way as Microsoft classifies them. This means that we cannot recognize outbound NOTIFY messages as being of the *Microsoft SIP IM&P* variant.

We are working on a fix for this issue so that we can route outbound NOTIFY using the *Microsoft SIP IM&P* variant. To work around it, the search rules for outbound NOTIFY must route on *All SIP Variants*.

Inbound Workaround

You need to create a search rule to match on the **Federation Routing IM/P FQDN** of the cluster. This is a cluster-wide SIP proxy parameter, configured on **System > Service Parameters > SelectPublisher > Cisco SIP Proxy > Federation Routing Parameters**.

In this document we are using the example value `IMP1-public.ciscoexample.com` for the Federation Routing IM/P FQDN of the cluster.

Outbound Workaround

Create a search rule on Expressway-E to route *All SIP Variants* for *Any alias* to the DNS zone. This should be the lowest priority rule, so it is only used when a more specific destination is not found. This is the workaround we document in our example dial plan for this deployment.

Outbound Workaround Option

If you don't want to enable a broad range of possible destinations, as per the first workaround, then you need to get more specific.

Create a search rule on Expressway-E to route *All SIP Variants* to the next SIP server in the routing path. Your Alias pattern for this rule could be different to the destination URI. For example, to reach users in Office 365 based organizations, the alias of the next SIP server in the path is `.*sipfed.online.lync.com`.

Configuration Summary

1. IM and Presence Service publisher:
 - Create a new Inter Domain Federation for each named federated domain. Use *OCS/Lync* type and do not select *Direct Federation*.
 - Create a static route to the Expressway-C for all traffic matching each federated domain.
For example, to route all traffic for *msexample.com*, use the format `.com.msexample`
Set the Route Type to *Domain*; use *TLS* as the preferred transport, enter the next hop FQDN (Expressway-C), and the preferred port 5061.
Put the route In Service.
 - Set the **Federation Routing IM/P FQDN**. For example, `IMP1-public.ciscoexample.com`.
2. Expressway-C: Neighbor zone to the IM and Presence Service cluster.
3. Expressway-C: Disable Presence Server (**Applications > Presence > SIP SIMPLE Presence Server Off**).

Modular Deployment Options

Dial Plan Description

- Expressway-E:
 - Search rule to route MS SIP IM&P for `.*@msexample\.com` from traversal server zone to DNS zone
 - Search rule to route MS SIP IM&P for `.*@ciscoexample\.com` from default zone to traversal server zone
- Expressway-C:
 - Search rule to route MS SIP IM&P for the named federation domain `.*@msexample\.com` from IM&P neighbor zone to traversal client zone.
 - Search rule to route MS SIP IM&P for local domain `.*@ciscoexample\.com` from traversal client zone to IM&P neighbor zone
 - For known limitation with presence: Search rule to route MS SIP IM&P from traversal client zone to IM&P neighbor zone. The rule must match on a regular expression that includes the **Federation Routing IM/P FQDN** of the target IM and Presence Service cluster.
For example, use `.*IMP1-public\.ciscoexample\.com.*` to match presence traffic for the FQDN given above.

Web Proxy for Cisco Meeting Server

This option enables external users to join or administer Meeting Server spaces using their browser. All the external user needs is the URL to the space and their credentials for accessing the Meeting Server.

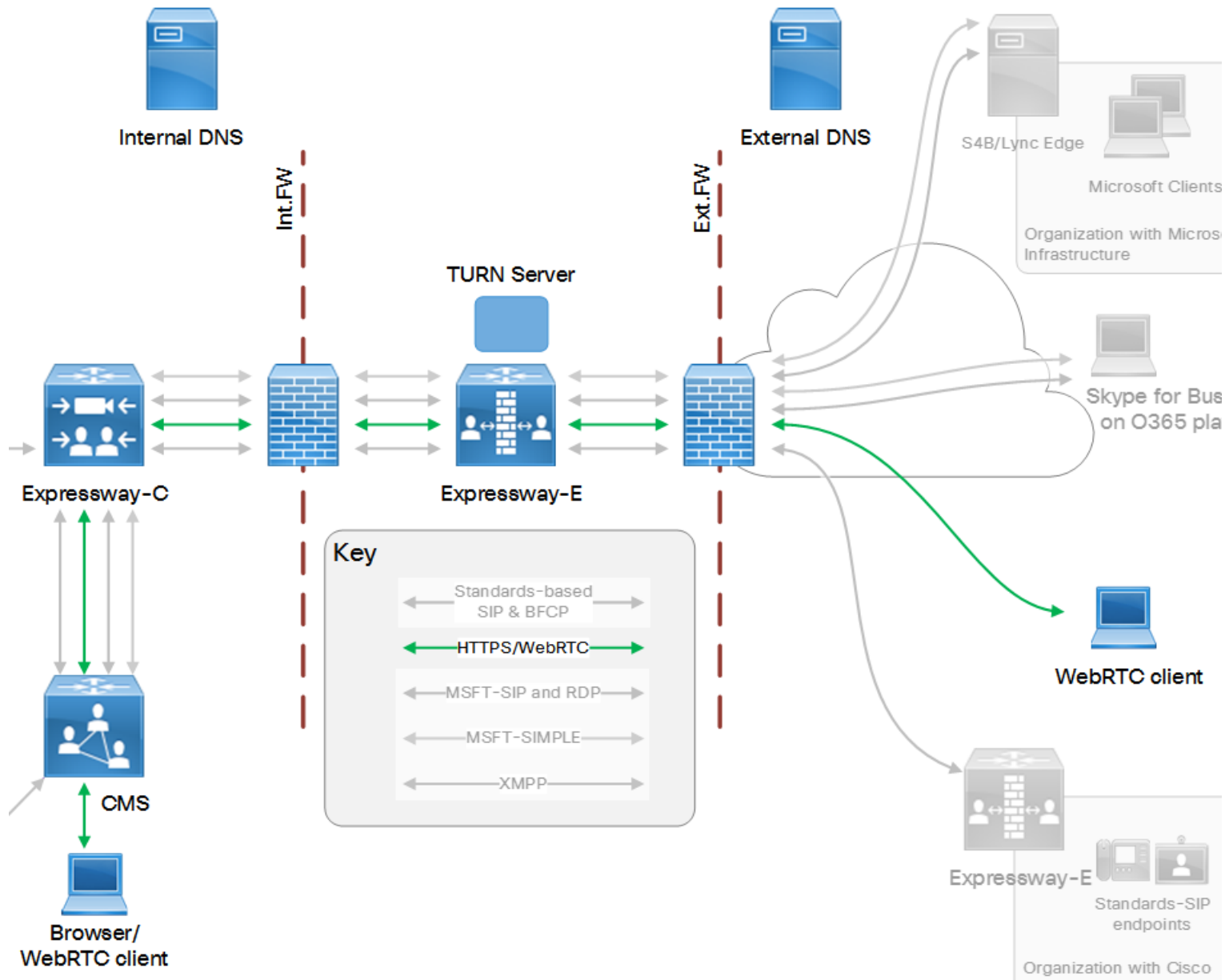

Technical Overview of Web Proxy for Meeting Server

The Web Proxy allows traffic from the internet destined for a Meeting Server web bridge. Typically this is to allow guest access to spaces on the Meeting Server, but can also be used for administering your spaces.

To allow WebRTC Clients to call into Meeting Server spaces from outside your network, you need to enable the Web Proxy. This is currently controlled by the *Mobile and Remote Access* mode on the Expressway-C and the Expressway-E, but you do not need to completely configure MRA.

The solution also needs TURN media relays, so you will need to configure Meeting Server with your TURN server details.

You can use the TURN server on Expressway-E, provided that you can listen externally on TCP and UDP 3478 and that your guests can connect to those ports on the Expressway-E's public IP address. See [Which TURN Server To Use?, page 22](#).

You do not need to create any SIP domains on the Expressway-C, and you can ignore the warning on **Status > Unified Communications** that states " *There are no Unified Communications domains configured.* " .

Co-existence

The Web Proxy for Meeting Server can co-exist on the Expressway with the following services:

- Mobile and Remote Access
- Business to Business AV Federation (including with Microsoft infrastructure-based businesses)
- IM&P Federation with Microsoft chat clients (as discussed in this document)
- Registrar

The Web Proxy for Meeting Server **cannot** co-exist on the Expressway with the following services:

- Jabber Guest
- Microsoft interoperability service (as controlled by the Microsoft Interoperability key. This is different from the Microsoft federations discussed in this document).

Limitations

- We do not currently support traversal of Cisco Meeting Application calls across the Expressway pair to the Meeting Server.
If WebRTC Client users attempt to use unsupported browsers, they will be redirected to download the Cisco Meeting Application, which will not work without installing the loadbalancer component on Cisco Meeting Server Edge. We recommend using the WebRTC Client with [a supported browser](#).
- Partial support for clustered Meeting Server web bridges: Load balancing is supported but redundancy is not. Expressway-C distributes WebRTC traffic to multiple Meeting Servers, based on its DNS lookup of the **Guest account client URI**. However, the Expressway-C does not currently adapt if any of the returned Meeting Server addresses are unreachable.
- The Web Proxy listens to the internet on port 443 on the Expressway-E. This port is not configurable and overlaps with the default web administration port.
The same port can be used for both purposes, and we distinguish the traffic destined for Meeting Server, but we strongly recommend that you change your web administrator access port on the Expressway-E. This means that you can prevent access to the web interface from the internet, while still allowing guest access to spaces.

Split DNS?

If you have split DNS in your environment, then we recommend using different A records for the web bridge internally and externally. Browsers outside your network will need to resolve the Expressway-E's public address when using the `join.example.com` domain, but browsers inside your network should resolve the listening interface of the Meeting Server web bridge instead.

Modular Deployment Options

If you can't split the DNS, you'll need to configure your firewall to allow browsers inside the network to resolve and reach the public address of the Expressway-E.

See [Appendix 1: DNS Entries, page 70](#).

Server Certificates

The Expressway-E certificate must list the Guest account client URI as a SAN.

Web Proxy for Meeting Server Configuration Summary

1. Install and configure Meeting Server, Expressway-C, and Expressway-E.
2. Apply a server certificate to the Meeting Server.
3. Enable the TURN server on either:
 - Expressway-E (**Configuration > Traversal > TURN**)
In this case, point the Meeting Server to the Expressway-E TURN server. (**Configuration > General**)
 - Meeting Server Edge Server
See the deployment guides on the [Cisco Meeting Server configuration guides page](#) to configure the TURN server on Cisco Meeting Server Edge.

See [Which TURN Server To Use?, page 22](#).

4. Change the web administration listening port on the Expressway-E. (**System > Administration**)
[Strongly recommended] Create a firewall rule to block access to the new administration port on the Expressway-E public interface.

Note: The UI limits you to choosing port 443 or 445, but you may wish to use a different port. If so, you can use the CLI command `xConfiguration Management Interface Port: nnnn` to set the port to your chosen value. If your Meeting Server deployment is co-existing with MRA, you should avoid using port 8443 for web administration. Also, you need to be careful not to choose a port that is already in use, because there is no check when you run the CLI command.

When you need to administer the Expressway-E (from inside the network), you should append the new port number to the address in the browser. If you changed the port to 445 for example, then `https://expe.ciscoexample.com:445` takes you to the Expressway-E login page, but `https://expe.ciscoexample.com` is refused.

5. Create Unified Communications traversal zones on Expressway-C and Expressway-E. (**Configuration > Zones > Zones**)
6. Create an external DNS A record for resolving the Guest account client URI to the Expressway-E's public IP address.

For example, create the record `join.ciscoexample.com` to target the Expressway-E's public interface.

Modular Deployment Options

7. Depending on whether you can split your DNS, do one of the following:
 - **If you can split DNS:** Create an A record on the internal DNS to resolve the **Guest account client URI** to the Meeting Server Web Bridge private IP address.
See [Internal DNS Records, page 72](#).
 - **If you cannot split DNS:**
Internal browsers will resolve the Expressway-E's public address when looking up the Guest account client URI. You may need to configure your firewall to allow these connections (outside the scope of this document).
 1. You must create a DNS SRV record for resolving the Guest account client URI to the FQDN of the Meeting Server web bridge.
For example, create the record `_cms-web._tls.join.ciscoexample.com` to target the Meeting Server FQDN, eg. `cms.ciscoexample.com` on port 443.
 2. Create DNS A record to resolve the Meeting Server FQDN, eg. `cms.ciscoexample.com` to the Meeting Server Web Bridge private IP address.
See [External DNS Records, page 70](#).
8. Enable MRA mode on the Expressway-C. (**Configuration > Unified Communications > Configuration**)
9. Enable MRA mode on the Expressway-E. (**Configuration > Unified Communications > Configuration**)
10. Add the **Guest account client URI**, eg. `join.ciscoexample.com`, as a SAN on the Expressway-E's server certificate.
11. Expressway-C: Enable the **Meeting Server Web Proxy** and enter the **Guest account client URI**. (**Configuration > Unified Communications > Cisco Meeting Server**)
This corresponds with the **Guest account client URI** on the Meeting Server web bridge settings.
Note: If you change the DNS entries for the guest account client URI, you must click **Refresh** on this page. To change the URI, edit the address field and click **Save**.

Modular Deployment Options

Web Proxy for Meeting Server Media Flows

Figure 12 Media Flow Between Internal WebRTC Client and Meeting Server

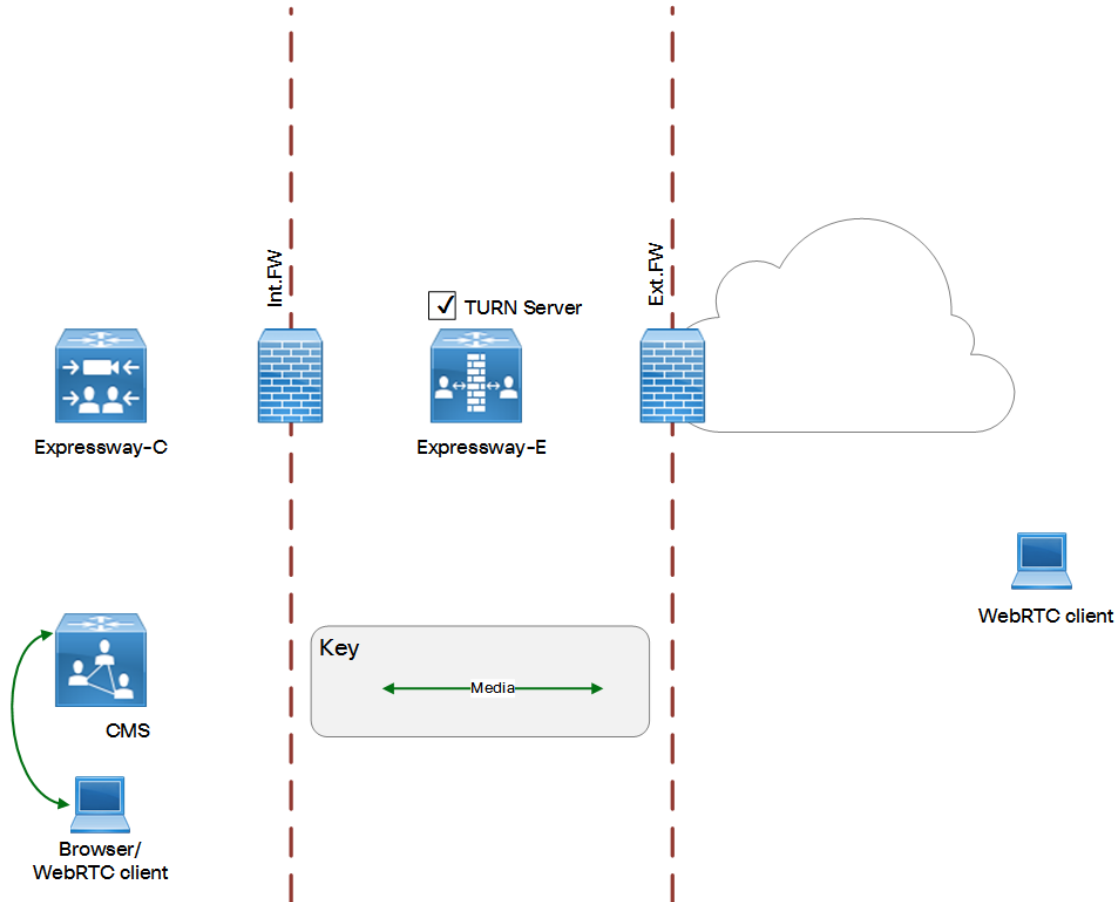

Modular Deployment Options

Figure 13 Media Flow Between External WebRTC Client and Meeting Server

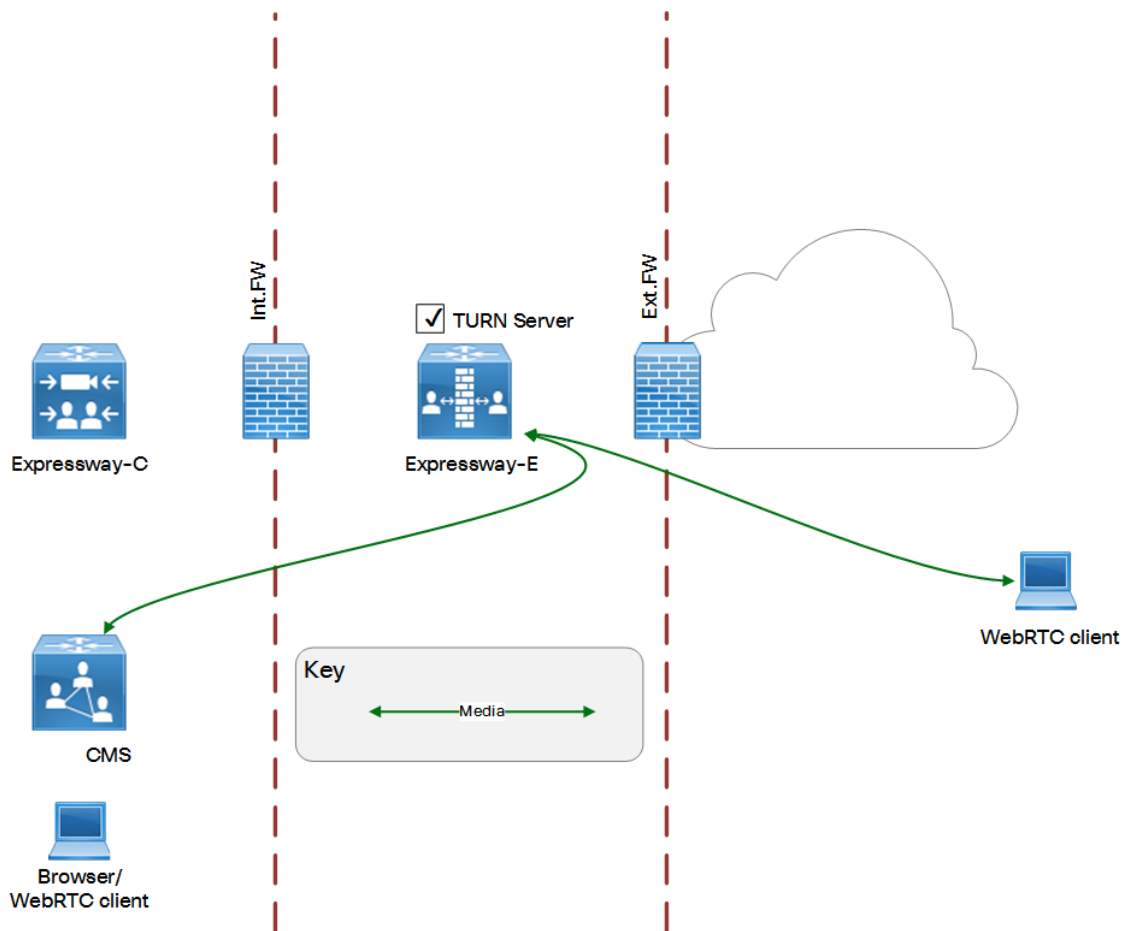

Appendix 1: DNS Entries

External DNS Records	70
Internal DNS Records	72

External DNS Records

Configure the external DNS with the records you need for your deployment. This table lists example records you may need for the purposes described in this document.

Table 14 DNS Configuration Summary

Purpose	Record type	Example entry	Port	Resolves to target
Resolve Expressway-E cluster FQDN to peer IP addresses	A	<code>expe.ciscoexample.com</code>		Public IP address of one Expressway-E cluster peer. Create one record for each peer in the Expressway-E cluster (Up to 6 records).
[Minimum requirement for external DNS] Enable guest browsers to find the Expressway-E reverse proxy Note: If you can split DNS, then we recommend you create a more direct mapping to the web bridge in your internal DNS.	A	<code>join.ciscoexample.com</code> (the Guest account client URI on the web bridge settings of the Meeting Server)	443	Public IP addresses of Expressway-E peers. Create one record for each peer in the Expressway-E cluster (Up to 6 records).
[Required if you cannot split DNS] Resolves service requests for the Meeting Server web bridge to Meeting Server FQDN. These SRV records are specifically used by the Expressway-C to find the internal Meeting Server web bridge details. Note: If you can split DNS, then we recommend you do not put this service record in the public DNS; this is an avoidable leak of information about internal servers.	SRV	<code>_cms-web._tls. join.ciscoexample.com.</code>	443	Internal FQDN of the Cisco Meeting Server, eg. <code>cms1.ciscoexample.com.</code>

Appendix 1: DNS Entries

Table 14 DNS Configuration Summary (continued)

Purpose	Record type	Example entry	Port	Resolves to target
This allows on-premises CMA users, and the Expressway-C, to connect to the web bridge. [This rule is required if you cannot split DNS. The external rule is not recommended if you can split DNS - see Internal DNS Records, page 72]	A	<i>cms1.ciscoexample.com</i> (FQDN of the Meeting Server)		(Private) IP address of the web bridge listening interface.
Discover destination for calls to third party Microsoft infrastructure domain (Outside of your control, but needs to be there for federation to succeed)	SRV	<i>_sipfederationtls._tcp.msexample.com.</i>	5061	Public address of Microsoft Skype for Business Edge server / cluster
Discover user destination for calls from third party Microsoft infrastructure domain	SRV	<i>_sipfederationtls._tcp.ciscoexample.com.</i>	5061	FQDN of Expressway-E cluster, eg. <i>expe.ciscoexample.com</i>
Discover space destination for calls from third party Microsoft infrastructure domain	SRV	<i>_sipfederationtls._tcp.cms.ciscoexample.com.</i>	5061	FQDN of Expressway-E cluster, eg. <i>expe.ciscoexample.com</i>
Discover target host for standards-based business to business federation, SIP UDP (Not recommended, and disabled by default on Expressway)	SRV	<i>_sip._udp.ciscoexample.com.</i>	5060	FQDN of Expressway-E cluster, eg. <i>expe.ciscoexample.com</i>
Discover target host for standards-based business to business federation, SIP TCP	SRV	<i>_sip._tcp.ciscoexample.com.</i>	5060	FQDN of Expressway-E cluster, eg. <i>expe.ciscoexample.com</i>
Discover target host for standards-based business to business federation, SIP TLS	SRV	<i>_sips._tcp.ciscoexample.com.</i>	5061	FQDN of Expressway-E cluster, eg. <i>expe.ciscoexample.com</i>

Deployment Limitations Related to DNS

DNS Load Balancing by Microsoft Skype for Business (also applies to Microsoft Lync Server and OCS)

Microsoft Skype for Business does not attempt to use DNS SRV load balancing when routing calls or messages to federated domains; the Microsoft Skype for Business Edge servers always choose the DNS SRV record with the lowest priority and highest weight, ignoring all others. When the priorities and weights are equal, they choose one and ignore all others.

Microsoft's best practices recommend that you configure round-robin A/AAAA record load balancing, using the A record *sip.domain.com*. That is, the DNS SRV record for SIP federation should have only one entry that targets a single round-robin A/AAAA record that includes all of your Expressway-E cluster peers.

For example:

- Create the SRV record *_sipfederationtls._tcp.ciscoexample.com.* with a single entry targeting *sip.ciscoexample.com*
- Create an A/AAAA record for *sip.ciscoexample.com* that targets either the public IP address of the Expressway-E, or multiple A/AAAA records for round-robin service of all the Expressway-E peers in the cluster.

Appendix 1: DNS Entries

Domain Namespace Compatibility for Microsoft Skype for Business (also applies to Microsoft Lync Server and OCS)

Microsoft Skype for Business requires that federated edge servers are in the same DNS namespace (domain/subdomain) as the federated SIP domain. If they are not in the same DNS namespace, then federation will fail without additional configuration on the Skype for Business servers.

We recommend that your DNS SRV records for SIP federation resolve to a target in the same DNS namespace, so that open SIP federation will work from the Microsoft side without requiring any additional configuration.

For example, if you intend to federate Microsoft infrastructure with the domain `cms.ciscoexample.com`, you would create the SRV record `_sipfederationtls._tcp.cms.ciscoexample.com.`. The target of that DNS SRV must be an A/AAAA record in the subdomain `cms.ciscoexample.com` (eg. `sip.cms.ciscoexample.com`). If the DNS SRV target were outside that namespace (eg. `sip.ciscoexample.com`) then the Microsoft side would not allow the connection.

Internal DNS Records

If you can split your DNS to give different results internally, then we recommend that you create different records for the following purposes. These records must be resolvable by Expressway-C.

Table 15 DNS Configuration Summary

Purpose	Record type	Example entry	Port	Resolves to
[This record is required if you have not configured the SRV record for <code>_cms-web._tls</code> in the public DNS. However, we recommend that you create it if you can, irrespective of whether the SRV record exists.] Resolves private IP address of Web Bridge listening interface. This allows on-premises WebRTC Clients to connect to the web bridge.	A	<code>join.ciscoexample.com</code> (the Guest account client URI on the web bridge settings of the Meeting Server)		IP address of the web bridge interface.
[Optional for internal DNS] Resolves service requests for the Meeting Server web bridge to individual Meeting Server FQDN.	SRV	<code>_cms-web._tls. join.ciscoexample.com.</code>	443	Internal FQDN of the Cisco Meeting Server web bridge, eg. <code>cms1.ciscoexample.com.</code>
For Expressway-C to resolve the Federation Routing IM/P FQDN of the IM and Presence Service cluster	A	<code>IMP1- public.ciscoexample.com</code>		IP address of the IM and Presence Service publisher

Appendix 2: Unsupported Deployments

1. Off-premises Microsoft clients traversing the Expressway pair to the on-premises Skype for Business Front End Servers. The topology is shown in [\[Unsupported\] Expressway Pair Traversing on Behalf of Microsoft On-Premises Infrastructure, page 75](#)

You must use Skype for Business Edge Server for this.

2. Unified CM handling Microsoft-variant SIP and invoking Meeting Server (in a media resource group) to do transcoding. [\[Unsupported\] Unified CM Invoking Meeting Server as a Transcoder \(MRG\), page 74](#).

This option is being investigated but is in no way supported in this release (X8.9).

3. Cisco Meeting Application traversing the Expressway pair to the Cisco Meeting Server.

This is work in progress, but not available in X8.9. External users can join with the WebRTC Client using [a supported browser](#).

[Unsupported] Unified CM Invoking Meeting Server as a Transcoder (MRG)

This option is not supported because Unified CM cannot currently invoke Cisco Meeting Server as a transcoder. The Meeting Server can be part of a Media Resource Group for other purposes, for example, for ad hoc conference escalation.

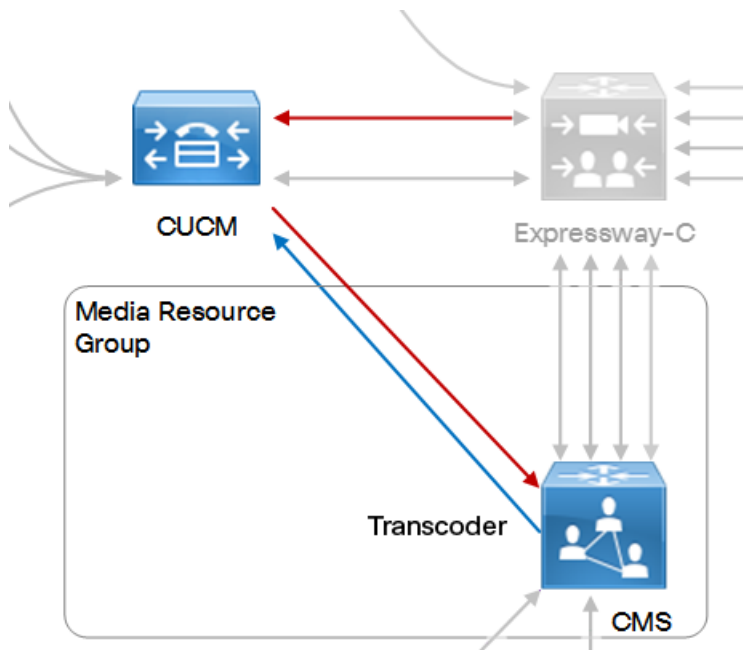

[Unsupported] Expressway Pair Traversing on Behalf of Microsoft On-Premises Infrastructure

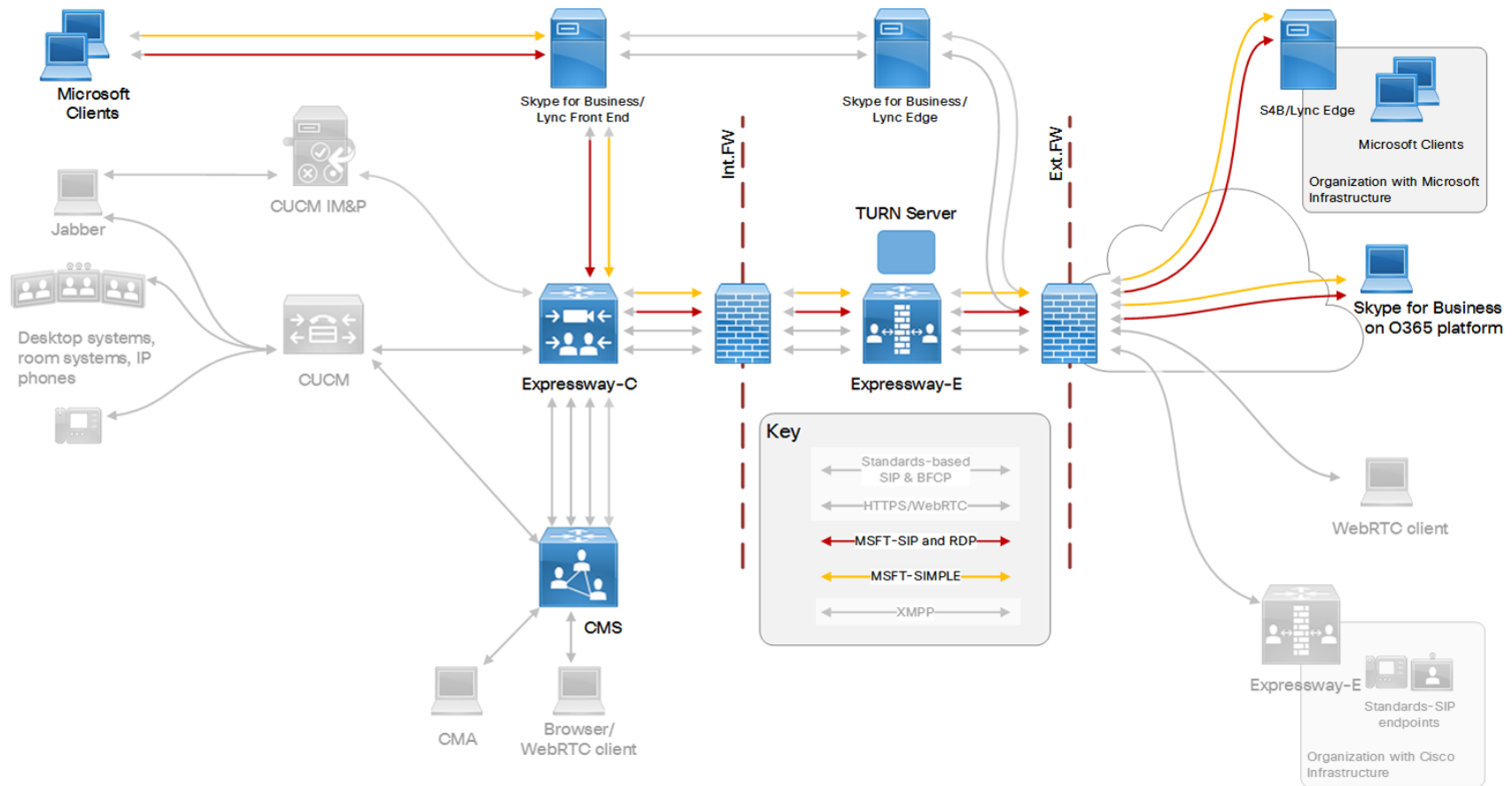

This option is not supported when the Expressway pair is configured as an edge for Meeting Server (this document). If you need to use on-premises Microsoft infrastructure to enable on- and off-premises Microsoft clients to join Meeting Server spaces, see the Microsoft integration topics in the Meeting Server deployment guides at [Cisco Meeting Server configuration guides page](#).

Appendix 3: Licensing and Performance

The core deployment described in this guide consumes different licenses in different places, depending on the traffic variant and zone encryption settings.

The performance numbers and license types depend on the series you use (VCS or Expressway).

Deployment License Usage on Large Expressway	76
Deployment License Usage on Large VCS	76

Deployment License Usage on Large Expressway

Table 16 License Usage for Meeting Server with Large Expressway Traversal Deployment

Traffic Variant	Maximum Concurrent Calls	Traversal Zone Encryption Mode	Meeting Server Neighbor Zone Encryption Mode	Call Type	Licenses Used on Expressway-E	Licenses Used on Expressway-C
Standards-based SIP	500	Auto	Auto	Traversal	Rich Media Sessions	None
Standards-based SIP	500	Other	Auto	Traversal and encryption	Rich Media Sessions	None
Standards-based SIP	500	Auto	Other	Traversal and encryption	Rich Media Sessions	None
Microsoft SIP	750	Auto*	Auto*	ICE call, not Traversal	Rich Media Sessions and TURN relays	None
WebRTC	500	N/A	N/A		TURN relays	None

* The Expressway ignores other values for this setting when processing Microsoft SIP, and treats all zones as if Media Encryption mode is set to Auto.

Deployment License Usage on Large VCS

Table 17 License Usage for Meeting Server with Large VCS Traversal Deployment

Traffic Variant	Maximum Concurrent Calls	Traversal Zone Encryption Mode	Meeting Server Neighbor Zone Encryption Mode	Call Type	Licenses Used on VCS Expressway	Licenses Used on VCS Control
Standards-based SIP	500	Auto	Auto	Traversal	Traversal Call licenses	Traversal Call licenses
Standards-based SIP	500	Other	Auto	Traversal and encryption	Traversal Call licenses	Traversal Call licenses

Appendix 3: Licensing and Performance

Table 17 License Usage for Meeting Server with Large VCS Traversal Deployment (continued)

Traffic Variant	Maximum Concurrent Calls	Traversal Zone Encryption Mode	Meeting Server Neighbor Zone Encryption Mode	Call Type	Licenses Used on VCS Expressway	Licenses Used on VCS Control
Standards-based SIP	500	Auto	Other	Traversal and encryption	Traversal Call licenses	Traversal Call licenses
Microsoft SIP	750	Auto*	Auto*	ICE call, not Traversal	Traversal Call licenses and TURN relays	Traversal Call licenses
WebRTC	500	N/A	N/A		TURN relays	None

* The Expressway ignores other values for this setting when processing Microsoft SIP, and treats all zones as if Media Encryption mode is set to Auto.

Cisco Legal Information

THE SPECIFICATIONS AND INFORMATION REGARDING THE PRODUCTS IN THIS MANUAL ARE SUBJECT TO CHANGE WITHOUT NOTICE. ALL STATEMENTS, INFORMATION, AND RECOMMENDATIONS IN THIS MANUAL ARE BELIEVED TO BE ACCURATE BUT ARE PRESENTED WITHOUT WARRANTY OF ANY KIND, EXPRESS OR IMPLIED. USERS MUST TAKE FULL RESPONSIBILITY FOR THEIR APPLICATION OF ANY PRODUCTS.

THE SOFTWARE LICENSE AND LIMITED WARRANTY FOR THE ACCOMPANYING PRODUCT ARE SET FORTH IN THE INFORMATION PACKET THAT SHIPPED WITH THE PRODUCT AND ARE INCORPORATED HEREIN BY THIS REFERENCE. IF YOU ARE UNABLE TO LOCATE THE SOFTWARE LICENSE OR LIMITED WARRANTY, CONTACT YOUR CISCO REPRESENTATIVE FOR A COPY.

The Cisco implementation of TCP header compression is an adaptation of a program developed by the University of California, Berkeley (UCB) as part of UCB's public domain version of the UNIX operating system. All rights reserved. Copyright © 1981, Regents of the University of California.

NOTWITHSTANDING ANY OTHER WARRANTY HEREIN, ALL DOCUMENT FILES AND SOFTWARE OF THESE SUPPLIERS ARE PROVIDED "AS IS" WITH ALL FAULTS. CISCO AND THE ABOVE-NAMED SUPPLIERS DISCLAIM ALL WARRANTIES, EXPRESSED OR IMPLIED, INCLUDING, WITHOUT LIMITATION, THOSE OF MERCHANTABILITY, FITNESS FOR A PARTICULAR PURPOSE AND NONINFRINGEMENT OR ARISING FROM A COURSE OF DEALING, USAGE, OR TRADE PRACTICE.

IN NO EVENT SHALL CISCO OR ITS SUPPLIERS BE LIABLE FOR ANY INDIRECT, SPECIAL, CONSEQUENTIAL, OR INCIDENTAL DAMAGES, INCLUDING, WITHOUT LIMITATION, LOST PROFITS OR LOSS OR DAMAGE TO DATA ARISING OUT OF THE USE OR INABILITY TO USE THIS MANUAL, EVEN IF CISCO OR ITS SUPPLIERS HAVE BEEN ADVISED OF THE POSSIBILITY OF SUCH DAMAGES.

Any Internet Protocol (IP) addresses and phone numbers used in this document are not intended to be actual addresses and phone numbers. Any examples, command display output, network topology diagrams, and other figures included in the document are shown for illustrative purposes only. Any use of actual IP addresses or phone numbers in illustrative content is unintentional and coincidental.

All printed copies and duplicate soft copies are considered un-Controlled copies and the original on-line version should be referred to for latest version.

Cisco has more than 200 offices worldwide. Addresses, phone numbers, and fax numbers are listed on the Cisco website at www.cisco.com/go/offices.

© 2017 Cisco Systems, Inc. All rights reserved.

Cisco Trademark

Cisco and the Cisco logo are trademarks or registered trademarks of Cisco and/or its affiliates in the U.S. and other countries. To view a list of Cisco trademarks, go to this URL: www.cisco.com/go/trademarks. Third-party trademarks mentioned are the property of their respective owners. The use of the word partner does not imply a partnership relationship between Cisco and any other company. (1110R)