

VIKING

TECHNICAL Practice

TELECOM SOLUTIONS FOR THE 21ST CENTURY

C-1000B

**Door Entry and CCTV
Camera Controller**

June 19, 2009

Add One or Two Doorboxes to an Existing Phone Line and Provide CCTV Camera Control

The **C-1000B** allows single line phones or phone systems to share a phone line with one or two Viking doorboxes or paging amplifiers. The **C-1000B** provides two Touch Tone controlled relays to operate door strikes or gate openers and **provides doorbox triggered CCTV camera switching**.

Viking doorboxes and paging amplifiers can be used on single line, residential or home office applications as well as on fully loaded systems, because they are no longer limited to installation on unused trunk ports.



Features

- Allows two **Viking** doorboxes or **Viking** paging amplifiers to share a single telephone line with a residential or business telephone system
- **Doorbox triggered CCTV camera switching**
- Custom ringing mode allows you to distinguish doorbox calls from C.O. calls
- Compatible with up to two of the following **Viking** doorbox models: **W-1000**, **W-2000A**, or **W-3000**. Alternatively, the Analog PABX/KSU station mode allows compatibility with a single **Viking** handsfree phone (**E-10A**, **E-20B**, **E-30**, **K-1700-3** or **1600A** Series)
- Compatible with **Viking's** Single Line Paging Controller, Model **SLP-1**.
- Call waiting tones indicate which doorbox is calling and distinguish a doorbox call from a C.O. line call
- Calls can be placed on hold when visitors call from the doorbox or when paging
- Provides two Touch Tone controlled N.O. or N.C. dry contact closures (5 amp rating) for door strikes or gate openers
- Keyless entry/postal lock input
- Built-in talk battery for "No C.O. Line" applications
- Auxiliary contact output for doorbells, lights, etc.

info@vikingelectronics.com

Applications

- Add one or two **Viking** Doorboxes to your home or office phones
- **Switch between two CCTV cameras automatically when either doorbox is activated**
- Add a **Viking SLP-1** Single Line Paging Controller to provide paging, intercom, loud ringing, door chime and music on hold features
- Provide commercial or residential security via two-way handsfree communication from a door or gate
- Use as a line concentrator (one fax machine or answering machine can answer three lines)

Phone... 715.386.8861

<http://www.vikingelectronics.com>

Specifications

Power: 120V AC/13.8V AC 1.25A, UL listed adapter provided
Dimensions: 133mm x 104mm x 44mm (5.25" x 4.1" x 1.75")
Shipping Weight: 0.9 kg (2 lb)
Environmental: 0° C to 32° C (32° F to 90° F) with 5% to 95% non-condensing humidity
Door Strike Relay Contacts: 5A @ 30V DC/250V AC maximum
CCTV/Auxiliary Relay Contacts: .5A @ 125V AC, 1A @ 30V DC
Pulse Dialing Detection: 10 pps
Talk Battery: 28V DC
Maximum Doorbox Power Supply Length: 100 ft, 24 awg wire
Connections: (1) 7 position terminal block and (1) 19 position terminal block

IF YOU HAVE A PROBLEM WITH A VIKING PRODUCT, PLEASE CONTACT: VIKING TECHNICAL SUPPORT AT (715) 386-8666

Our Technical Support Department is available for assistance Monday 8am-4pm and Tuesday-Friday 8am - 5pm central time. So that we can give you better service, before you call please:

1. Know the model number, the serial number and what software version you have (see serial label).
2. Have your Technical Practice in front of you.
3. It is best if you are on site.

RETURNING PRODUCT FOR REPAIR

The following procedure is for equipment that needs repair:

1. Customer must contact Viking's Technical Support Department at 715-386-8666 to obtain a Return Authorization (RA) number. The customer MUST have a complete description of the problem, with all pertinent information regarding the defect, such as options set, conditions, symptoms, methods to duplicate problem, frequency of failure, etc.
2. Packing: Return equipment in original box or in proper packing so that damage will not occur while in transit. Static sensitive equipment such as a circuit board should be in an anti-static bag, sandwiched between foam and individually boxed. All equipment should be wrapped to avoid packing material lodging in or sticking to the equipment. Include ALL parts of the equipment. C.O.D. or freight collect shipments cannot be accepted. Ship cartons prepaid to:
Viking Electronics, 1531 Industrial Street, Hudson, WI 54016
3. Return shipping address: Be sure to include your return shipping address inside the box. We cannot ship to a PO Box.
4. RA number on carton: In large printing, write the R.A. number on the outside of each carton being returned.

RETURNING PRODUCT FOR EXCHANGE

The following procedure is for equipment that has failed out-of-box (within 10 days of purchase):

1. Customer must contact Viking's Technical Support at 715-386-8666 to determine possible causes for the problem. The customer MUST be able to step through recommended tests for diagnosis.
2. If the Technical Support Product Specialist determines that the equipment is defective based on the customer's input and troubleshooting, a Return Authorization (R.A.) number will be issued. This number is valid for fourteen (14) calendar days from the date of issue.
3. After obtaining the R.A. number, return the approved equipment to your distributor, referencing the R.A. number. Your distributor will then replace the product over the counter at no charge. The distributor will then return the product to Viking using the same R.A. number.
4. **The distributor will NOT exchange this product without first obtaining the R.A. number from you. If you haven't followed the steps listed in 1, 2 and 3, be aware that you will have to pay a restocking charge.**

WARRANTY

Viking warrants its products to be free from defects in the workmanship or materials, under normal use and service, for a period of one year from the date of purchase from any authorized Viking distributor or 18 months from the date manufactured, whichever ever is greater. If at any time during the warranty period, the product is deemed defective or malfunctions, return the product to Viking Electronics, Inc., 1531 Industrial Street, Hudson, WI, 54016. Customer must contact Viking's Technical Support Department at 715-386-8666 to obtain a Return Authorization (R.A.) number.

This warranty does not cover any damage to the product due to lightning, over voltage, under voltage, accident, misuse, abuse, negligence or any damage caused by use of the product by the purchaser or others.

Viking's sole responsibility shall be to repair or replace (at Viking's option) the material within the terms stated above. VIKING SHALL NOT BE LIABLE FOR ANY LOSS OR DAMAGE OF ANY KIND INCLUDING INCIDENTAL OR CONSEQUENTIAL DAMAGES RESULTING DIRECTLY OR INDIRECTLY FROM ANY BREACH OF ANY WARRANTY EXPRESSED OR IMPLIED, OR FOR ANY OTHER FAILURE OF THIS PRODUCT. Some states do not allow the exclusion or limitation of incidental or consequential damages, so this limitation may not apply to you.

THIS WARRANTY IS IN LIEU OF ALL OTHER WARRANTIES, EXPRESSED OR IMPLIED, INCLUDING THE WARRANTIES OF MERCHANTABILITY AND FITNESS FOR A PARTICULAR PURPOSE, WHICH ARE HEREBY EXCLUDED BEYOND THE ONE YEAR DURATION OF THIS WARRANTY. Some states do not allow limitation on how long an implied warranty lasts, so the above limitation may not apply to you.

FCC REQUIREMENTS

This equipment complies with Part 68 of the FCC rules and the requirements adopted by the ACTA. On the side of this equipment is a label that contains, among other information, a product identifier in the format US:AAAEQ##TXXXX. If requested, this number must be provided to the telephone company.

The REN is used to determine the number of devices that may be connected to a telephone line. Excessive REN's on a telephone line may result in the devices not ringing in response to an incoming call. In most but not all areas, the sum of the REN's should not exceed five (5.0). To be certain of the number of devices that may be connected to a line, as determined by the total REN's, contact the local telephone company. For products approved after July 23, 2001, the REN for this product is part of the product identifier that has the format US:AAAEQ##TXXXX. The digits represented by ## are the REN without a decimal point (e.g., .03 is a REN of 0.3). For earlier products, the REN is separately shown on the label.

The plug used to connect this equipment to the premises wiring and telephone network must comply with the applicable FCC Part 68 rules and requirements adopted by the ACTA. If your home has specially wired alarm equipment connected to the telephone line, ensure the installation of this C-1000B does not disable your alarm equipment. If you have questions about what will disable alarm equipment, consult your telephone company or a qualified installer.

If the C-1000B causes harm to the telephone network, the telephone company will notify you in advance that temporary discontinuance of service may be required. But if advance notice isn't practical, the telephone company will notify the customer as soon as possible. Also, you will be advised of your right to file a complaint with the FCC if you believe it is necessary.

The telephone company may make changes in its facilities, equipment, operations, or procedures that could affect the operation of the equipment. If this happens, the telephone company will provide advance notice in order for you to make the necessary modifications to maintain uninterrupted service.

If trouble is experienced with the C-1000B, for repair or warranty information, please contact:

Viking Electronics, Inc., 1531 Industrial Street, Hudson, WI 54016 (715) 386-8666

If the equipment is causing harm to the telephone network, the telephone company may request that you disconnect the equipment until the problem is resolved.

Connection to Party Line Service is subject to State Tariffs. Contact the state public utility commission, public service commission or corporation commission for information.

WHEN PROGRAMMING EMERGENCY NUMBERS AND (OR) MAKING TEST CALLS TO EMERGENCY NUMBERS:

Remain on the line and briefly explain to the dispatcher the reason for the call. Perform such activities in the off-peak hours, such as early morning or late evenings.

It is recommended that the customer install an AC surge arrester in the AC outlet to which this device is connected. This is to avoid damaging the equipment caused by local lightning strikes and other electrical surges.

PART 15 LIMITATIONS

This equipment has been tested and found to comply with the limits for a Class A digital device, pursuant to Part 15 of the FCC Rules. These limits are designed to provide reasonable protection against harmful interference when the equipment is operated in a commercial environment. This equipment generates, uses, and can radiate radio frequency energy and, if not installed and used in accordance with the instruction manual, may cause harmful interference to radio communications. Operation of this equipment in a residential area is likely to cause harmful interference in which case the user will be required to correct the interference at his own expense.

Features Overview

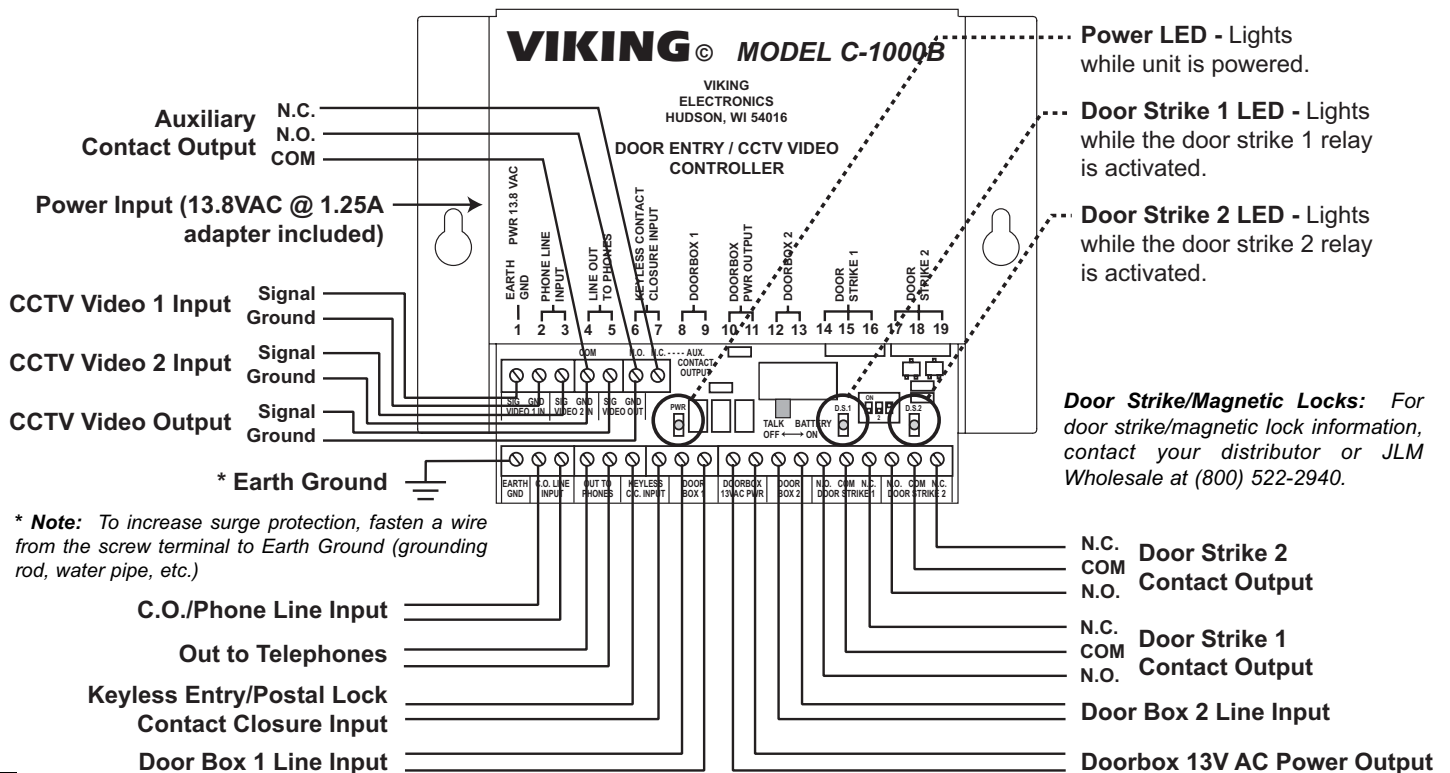

* **Note:** To increase surge protection, fasten a wire from the screw terminal to Earth Ground (grounding rod, water pipe, etc.)

Installation and Applications



IMPORTANT: Electronic devices are susceptible to lightning and power station electrical surges from both the AC outlet and the telephone line. It is recommended that a surge protector be installed to protect against such surges. Contact Panamax at (800) 472-5555 or Electronic Specialists Inc. at (800) 225-4876.

A. One or Two Doorboxes Sharing a Phone Line and Controlling Two Optional Cameras

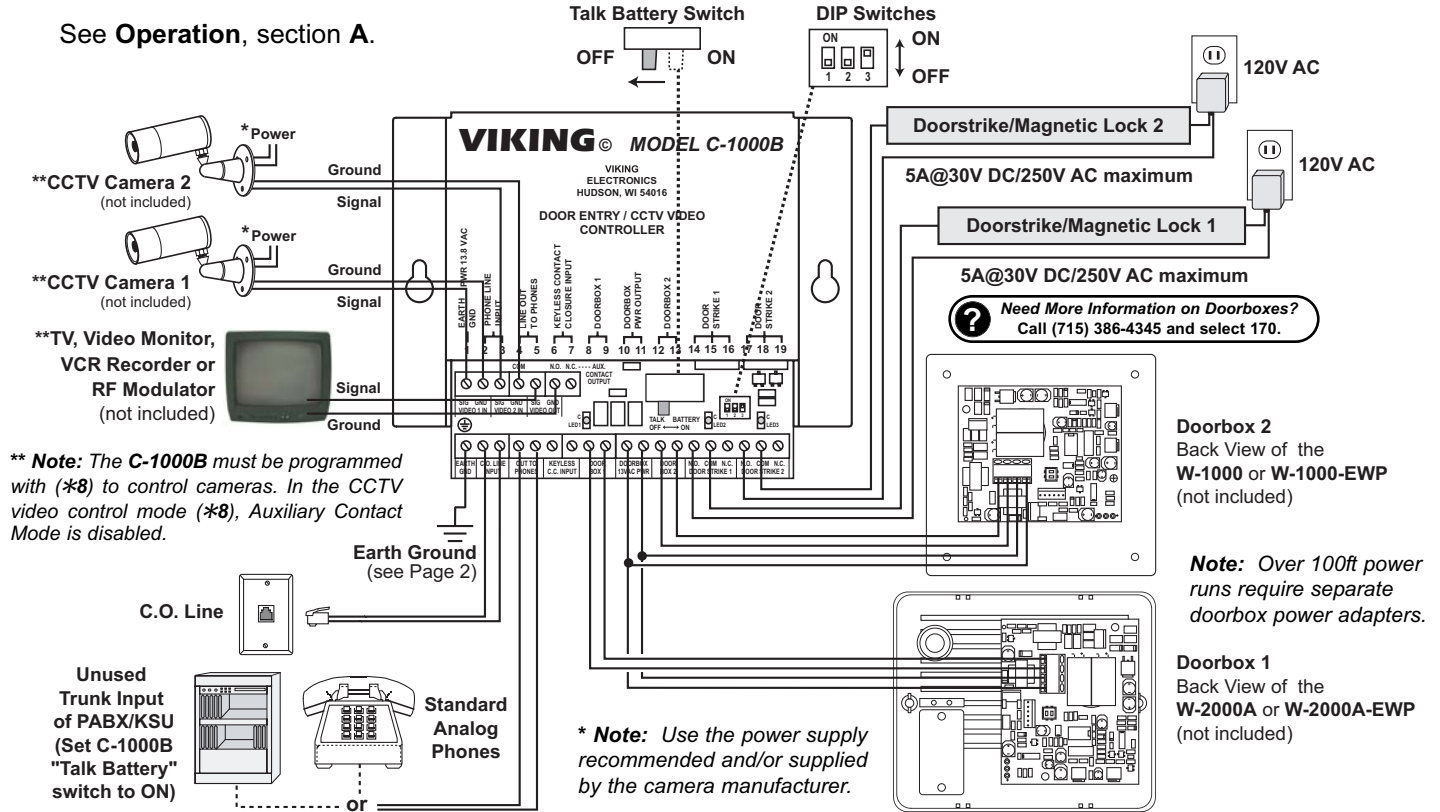

B. Provide Paging, Doorbox, and Doorstrike Control with Unique Front and Back Door Chimes

Note: To provide unique front and back door chimes, the C-1000B must be programmed to enable the "Auxiliary Contact Mode" (*7) and have the auxiliary contact programmed for custom ring cadence (12#03). Doorbox ringing can also be disabled by placing the C-1000B in the "Doorbell Mode" (*1). See **Quick Programming Features**, page 6. The C-1000B CCTV Video Control Mode can **NOT** be used in conjunction with unique front and back door chimes. See **Operation** section I, page 7. If CCTV video control is required, a Viking VC-1000 can be used. The caller's music on hold is limited to 5 seconds while communicating with a doorbox.

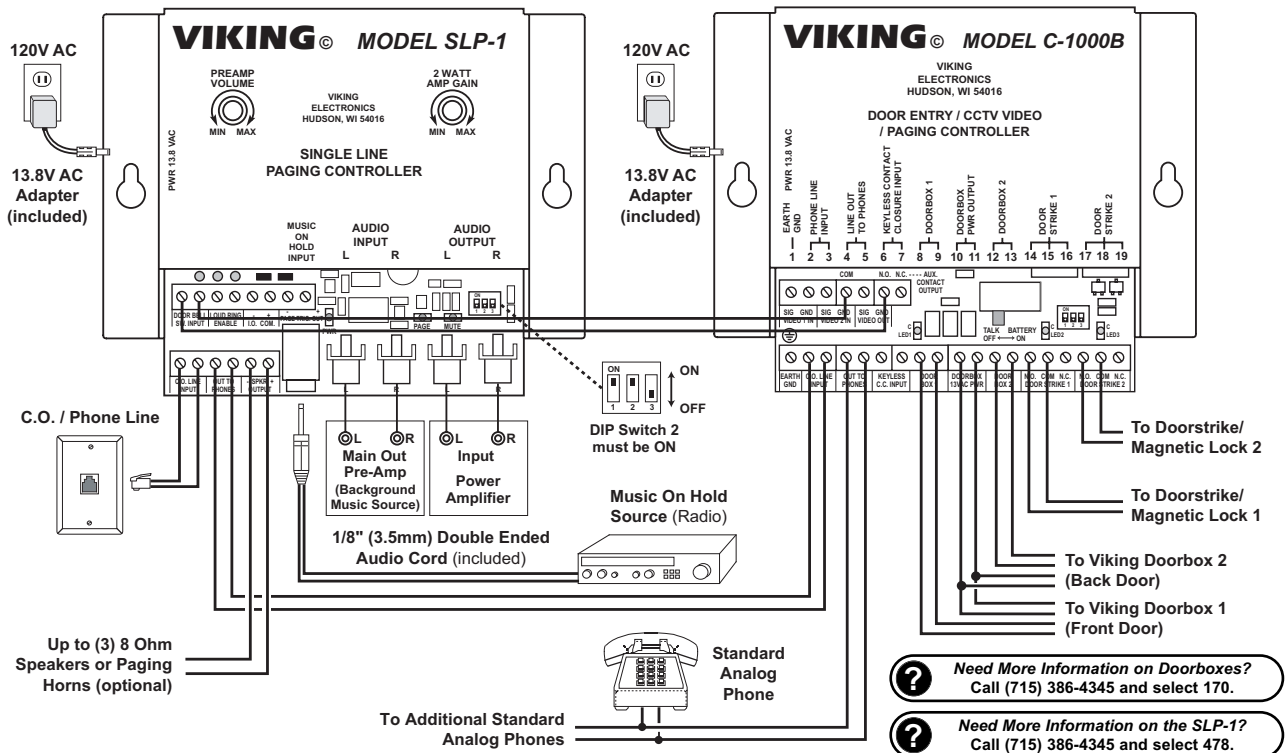

C. Using a C-1000B without a C.O. Line

The **C-1000B** can also be used without a C.O. line. This is ideal for connecting the **C-1000B** to an unused trunk/line input of your phone system or connecting to phones used only for doorbox communication.

| | |
|----------------|--|
| Step 1. | Connect the power, required doorboxes, and doorstrike outputs (if required) as shown in section A. |
| Step 2. | Connect an analog phone or unused PABX/KSU trunk port to terminals 4 & 5, "LINE OUT TO PHONES" on the C-1000B . |
| Step 3. | Be sure the "Talk Battery Switch" is in the ON position. |

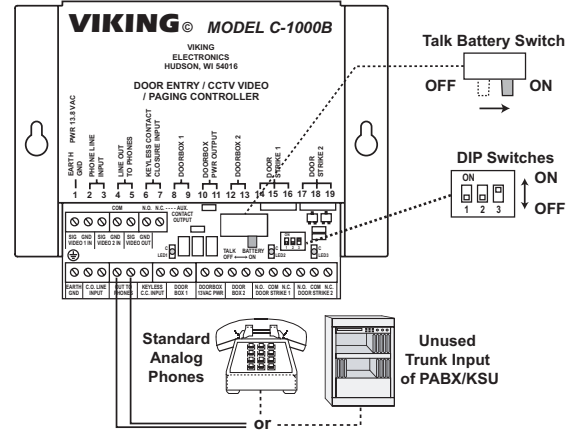

D. Using the C-1000B with Keyless Entry, Proximity Card Reader or a Postal Lock Switch

| | |
|----------------|--|
| Step 1. | Connect a device that can provide a momentary contact closure, such as the Viking ES-1 with HID-1 Card Reader or HID-2 Keypad, keyed switch, postal lock with limit switch, etc. to terminals 6 & 7, "KEYLESS CONTACT CLOSURE INPUT". |
| Step 2. | Connect doorboxes and doorstrike outputs (if required) as shown in section A. |
| Step 3. | See Operation section A, 5. Keyless Entry/Postal Lock . |

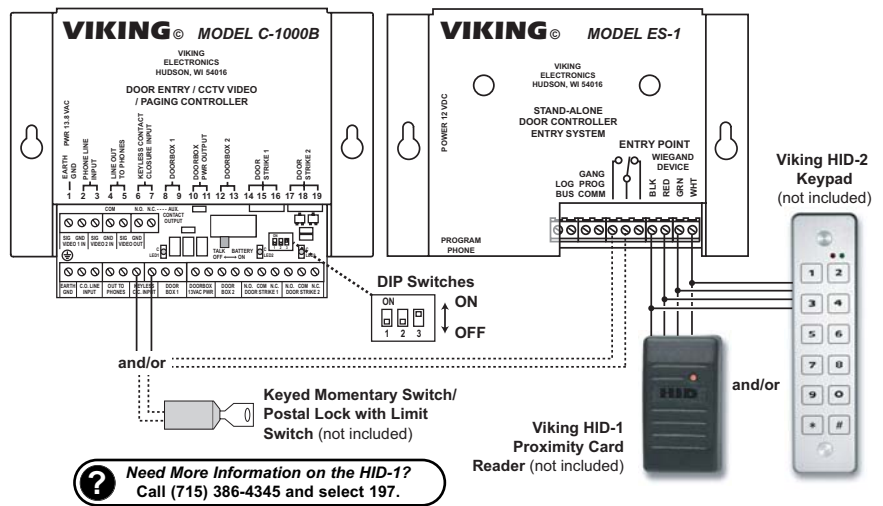

- Need More Information on the ES-1?**
Call (715) 386-4345 and select 193.
- Need More Information on the HID-2?**
Call (715) 386-4345 and select 199.
- Need More Information on the HID-1?**
Call (715) 386-4345 and select 197.

E. Using the C-1000B to Trigger a Doorbell

| | |
|----------------|---|
| Step 1. | Connect the doorbell (not included) as shown to the right. Note: The C-1000B will not supply power to the doorbell, a power adapter is necessary. |
| Step 2. | Connect doorboxes and doorstrike outputs (if required) as shown in section A. |
| Step 3. | Program the Auxiliary Contact Output as desired (see Programming section B). |
| Step 4. | See Operation section A, 6. Auxiliary Contacts . |

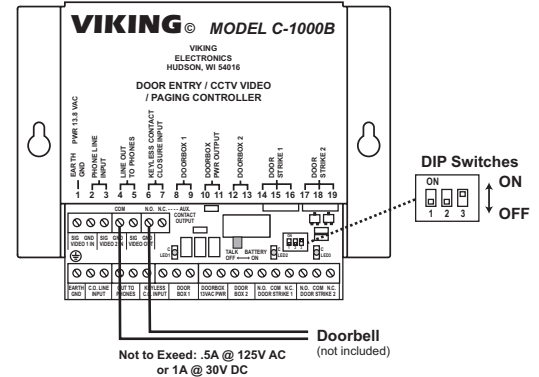

F. Line Concentrator Mode (One Telecom Device Can Answer up to Three Lines)

The **C-1000B** can be used as a line concentrator, allowing up to three separate C.O. lines to connect to one telecom device. For more information: call 715-386-4345 and select **872**.

G. Using the C-1000B with Three Doorboxes and No C.O. Line

The **C-1000B** can be used to control up to three doorboxes. For more information: call 715-386-4345 and select **872**.

H. Using the C-1000B on an Analog Station Port (Analog PABX/KSU Station Mode)

Note: This mode can NOT be used with W-1000, W-2000A or W-3000 doorbells. This application is ideal for connecting the C-1000B to an unused analog station of your phone system. See Programming section F and Operation section A.

Important:

1. In this application, only a single door phone is used and *5 must be selected when in programming.
2. Do not program the CCTV Video Control Mode (*8) in this application (See Note 2 below). Only Auxiliary Contact Mode (*7) can be used.

Notes:

- *1. The K-1700-3's keypad can be used for extension dialing, etc., but can NOT be used for keyless entry (see Installation and Applications section D).
2. If "Switched" camera control is needed (for a switching video RF modulator), connect the camera to "Video 2 In", connect the RF Modulator to "Video Out" and program the C-1000B with "*7" and "11 # 03".
3. Once the "Analog PBX/KSU Station Mode" (*5) has been programmed, you are not able to access the programming mode of the C-1000B in the normal fashion. For details, see Programming, Section A.
- **4. The K-1900-5's touch tone and flash restrictions must be disabled (*02). See the K-1900-5 Technical Practice for complete programming instructions, DOD# 317.

Need more information on the products shown to the right?
Call 715-386-4345 and enter the fax number below:

| Model | Fax # | Description |
|-------------|-------|--|
| E-10A/E-20B | 210 | Handsfree Speaker Phone |
| E-30 | 212 | Vandal Resistant Handsfree Speaker Phone |
| E-1600A | 215 | Emergency/Elevator Phone |
| K-1700-3 | 157 | Handsfree Speaker Phone with Keypad |
| K-1900-5 | 317 | Touch Tone Dialer |

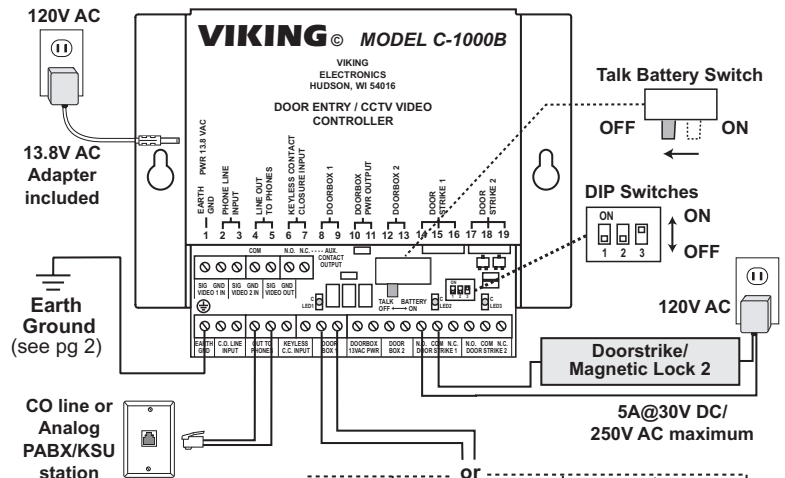

Programming

A. Accessing the Programming Mode

Follow Sections 1 or 2 to program a new C-1000B or any C-1000B that has not been previously programmed into the "Analog PBX/KSU Station Mode" (*5). If the "Analog PBX/KSU Station Mode" has been programmed, follow Sections 3 or 4 to access programming.

Note: If you are not sure how the C-1000B was previously programmed and have difficulty accessing the programming mode by following Sections 1 or 2, follow Sections 3 or 4 in case the C-1000B is currently in the "Analog PBX/KSU Station Mode" (*5).

1. Accessing the Programming Mode Locally (Security Code Bypass Mode)

| | |
|----------------|--|
| Step 1. | Disconnect the PHONE LINE INPUT . |
| Step 2. | Slide the TALK BATTERY switch to the ON position. |
| Step 3. | Move DIP switch 2 from OFF to ON (see Programming section E). |
| Step 4. | Come off-hook with a phone connected to terminals 4 & 5, LINE OUT TO PHONES . |
| Step 5. | A double beep will indicate that you have accessed the programming mode. |
| Step 6. | You can now Touch Tone program the features listed in section B below. |
| Step 7. | When finished programming, hang up and move DIP switch 2 to the OFF position. |
| Step 8. | Slide the TALK BATTERY switch back to the OFF position. |
| Step 9. | Reconnect line to PHONE LINE INPUT . |

2. Accessing the Programming Mode Remotely

| | |
|----------------|---|
| Step 1. | Call into the C-1000B from a Touch Tone phone. |
| Step 2. | Answer the call using the phone (device) connected to terminals 4 & 5, LINE OUT TO PHONES . |
| Step 3. | From either phone enter * followed by the security code (factory set to 845464 , see Programming section D). |
| Step 4. | A double beep will indicate that you have accessed the programming mode. |
| Step 5. | You can now Touch Tone program the features listed in section B below. |
| Step 6. | When finished, hang up both phones to exit the programming mode |

Note: Programming from a cell-phone may not be suitable in areas with weak coverage.

IMPORTANT: Only use Sections 3 or 4 when the C-1000B has previously been programmed into the “Analog PBX/KSU Station Mode” (*5)

3. Accessing the Programming Mode Locally (When *5 mode has been programmed)

| | |
|----------------|---|
| Step 1. | Connect a PBX/KSU analog extension (or phone line) to terminals 4 & 5, LINE OUT TO PHONES . |
| Step 2. | Slide the TALK BATTERY switch to the OFF position. |
| Step 3. | Move DIP switch 2 from OFF to ON (see Programming section E). |
| Step 4. | Come off-hook with a phone connected to terminals 8 & 9 DOORBOX 1 . |
| Step 5. | PBX/KSU dial tone will be heard along with a double beep from the C-1000B to indicate that you have accessed the programming mode. |
| Step 6. | You can now Touch Tone program the features listed in section B below. (ignore busy signals, reorder tones or intercept messages heard while programming). |
| Step 7. | When finished programming, hang up and move DIP switch 2 to the OFF position. |

4. Accessing the Programming Mode Remotely (When *5 mode has been programmed)

Note: To access programming in this fashion, there must be a PBX/KSU analog extension (or phone line) connected to terminals 4 & 5, **LINE OUT TO PHONES** and the **TALK BATTERY** switch must be set to **OFF**.

| | |
|----------------|--|
| Step 1. | From another extension or phone line, call into the PBX/KSU analog extension (or phone line) connected to terminals 4 & 5, LINE OUT TO PHONES . |
| Step 2. | Answer the call using the phone (or device) connected to terminals 8 & 9, DOORBOX 1 . |
| Step 3. | From the remote phone enter * followed by the six digit security code (factory set to 845464, see programming Section D). |
| Step 4. | A double beep will indicate that you have accessed the programming mode. |
| Step 5. | You can now Touch Tone program the features listed in section B below. |
| Step 6. | When finished programming, hang up both phones. |

B. Quick Programming Features

| | Enter Digits - then - | Memory Location |
|---|---------------------------|-----------------|
| Door strike 1 activation time .5 - 10 seconds (00 = .5 seconds/factory default) | 2 digits (00-10) + | #01 |
| Door strike 2 activation time .5 - 10 seconds (00 = .5 seconds/factory default) | 2 digits (00-10) + | #02 |
| Security Code (factory set to 845464) | 6 digits (0-9) + | #47 |
| Disable special modes (*1 - *6 and *8) listed below (factory default) | *0 | |
| * Doorbell mode | *1 | |
| * Custom ring mode | *2 | |
| * Multiple relay activation mode | *3 | |
| * Paging mode (not for use with SLP-1 , see Programming , Section F) | *4 | |
| * Analog PABX/KSU station mode | *5 | |
| * Inhibit latching commands mode | *6 | |
| Auxiliary contact mode (disables CCTV video control mode, factory default) | *7 | |
| Auxiliary contact activation time .5 - 10 seconds (00 = .5 seconds/factory default)..... | 2 digits (00-10) + | #03 |
| Auxiliary contact latched while either doorbox is activated | 11 + | #03 |
| ** Auxiliary contact activated in custom ring cadence | 12 + | #03 |
| **CCTV video control mode (disables auxiliary contact mode) | *8 | |
| CCTV Inactive (Idle State) Modes: | | |
| Camera 1 and 2 output disconnected (factory default) | 01 + | #04 |
| Output camera 1 | 02 + | #04 |
| Continue to output video from last camera activated | 03 + | #04 |
| Sequenced video from camera 1 and 2 (rotates every 4 seconds) | 04 + | #04 |
| To reset to factory settings | ### | |

* **Note:** Multiple modes may be selected.

** **Note:** Not compatible with Analog PABX/KSU Station mode.

C. Programming Examples

| To Program the C-1000B... | Enter |
|---|---------------|
| 1. ...to set door strike 1 to activate for 3 seconds | 03 #01 |
| 2. ...to set the auxiliary contacts to activate an external ringer or strobe light in a custom ring cadence while either doorbox is ringing | 12 #03 |
| 3. ...to have doorboxes ring phones in a custom ring pattern | *2 |

D. Security Code

This six digit number can be used to access the programming mode. The security code has been factory set to **845464** (V-I-K-I-N-G). It is recommended that you change the security code to a personal 6 digit number. To change the security code, access programming (see **Programming** section **A**). Enter six digits 0-9 followed by **#47**. If you have forgotten your security code, follow the steps in **Programming** section **A, 1. Accessing the Programming Mode Locally**. **Note:** *The security code must be six digits in length and can NOT contain a * or #.*

E. Dip Switch Programming

| Switch | Position | Description |
|--------|----------|---|
| 1 | OFF | Doorstrike Activation = 0.5 seconds (factory setting) |
| 1 | ON | Doorstrike Activation = 10 seconds |
| 2 | OFF | Normal Mode (factory setting) |
| 2 | ON | Security Code Bypass Mode |
| 3 | OFF | Line Concentrator Mode |
| 3 | ON | Normal Operation (factory setting) |

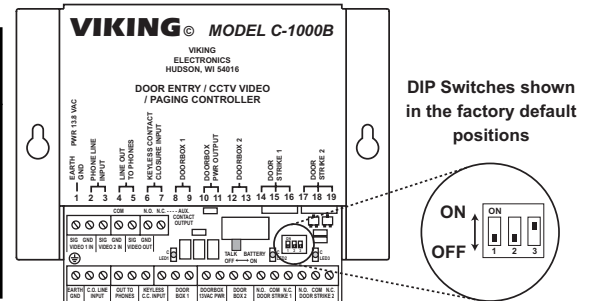

F. Mode Descriptions

Entering these codes while in programming will switch the **C-1000B** into the corresponding mode.

Disable Special Modes (*0): This command disables (clears) all the special modes listed below. Enter this command before programming the rest of the selections to be sure no unwanted modes are set.

Doorbell Mode (*1): In this mode, the ring signal from either doorbox is prevented from going through to the “**LINE OUT TO PHONES**” terminals. This is useful when a conventional door bell is connected to the auxiliary contacts. Now when someone activates a doorbox, the doorbell will chime rather than the phone ringing (see **Programming** section **B**).

Custom Ring Mode (*2): With this mode selected, the ring signal from the device ports are interrupted in a double burst pattern, making it easier to determine if the incoming call is from a doorbox or the C.O. line. **Note:** *Some telephones and phone systems are not compatible with this feature.*

Multiple Relay Activation Mode (*3): If selected, after a door strike command is entered, the phone is switched back to the doorbox port so additional doorstrike (relay activation) commands can be entered. This is useful when letting someone through your gate with the first command then unlocking your front doorstrike with a second command. To return to the call on hold, enter “**#**”.

Paging Mode (*4): This mode is used for basic paging and/or existing installations using a **C-1000B** with a **Viking** paging amplifier such as model: **PA-2A**. For more information, retrieve Fax Back Document **485**. This mode is **NOT** for use with model **SLP-1**. For single line paging applications, the **SLP-1** is recommended, see **Installation** section **B** and retrieve Fax Back Document **478**.

Analog PABX/KSU Station Mode (*5): This mode is ideal when installing the **C-1000B** on a phone system that does not have a spare trunk port but does have an unused analog station port. This mode allows any standard (POTS) telephone such as the **E-10A**, **E-20B**, **E-30** or **K-1700-3** to be used in place of Doorbox 1. Only one door phone can be used in this mode. When the door phone goes off-hook, a hot-line dialer or ringdown station will call the desired phone system extension. The phone on that extension can then communicate with the door phone and activate doorstrikes as needed. **Note:** *Only a single door phone may be used. Multiple relay activation cannot be used with Viking door phone models **E-10A**, **E-20B**, **E-30** or **K-1700-3**.*

Inhibit Latching Commands Mode (*6): In some installations it is critical that the door strike or door actuator not be turned on for long periods of time. To prevent this from happening, enter ***6** when in programming. In this mode, the toggle command (***#**) and the continuous activation command (***1**) are ignored.

Auxiliary Contact Mode (*7): See **Operation** section **6**, page **8**.

CCTV Video Control Mode (*8): In this mode the **C-1000B** allows two CCTV video cameras to be concentrated down to one video signal, by switching to the camera at the zone/entry point being used. When the **C-1000B** detects a doorbox ringing or when a doorbox is monitored, it will connect that camera’s video feed to the video output. When both doorboxes are inactive (idle), the **C-1000B** can be programmed to do one of four operations (see **Operation**, Section **C**, page **8**). **Note:** *The CCTV Video Control Mode (*8) is disabled when using the Auxiliary Contact Mode (*7).*

Operation

A. Doorbox Controller

1. Communicating with the Doorbox

a. Visitor Initiated Call

A visitor pressing the “Call” button will cause the phones connected to the “**LINE OUT TO PHONES**” terminals to ring. Simply answer your phone to converse with the visitor. After answering the call, a single or double beep will be heard in the phone, indicating which doorbox has called - a single beep for doorbox 1 and a double beep for doorbox 2.

b. Monitoring Doorboxes

A doorbox may be monitored from any phone connected to the **C-1000B** by Touch Tone dialing a “**#**” followed by a Touch Tone “**1**” or “**2**” to monitor doorbox 1 or doorbox 2 respectively. This feature is not available for pulse dialing phones. **Note:** *Do not attempt doorbox monitoring while a call is in progress, the call will be disconnected. Note: When monitoring, the auxiliary contact will only work in the **Continuous Mode (11 # 03)**.*

2. Placing C.O. Line Calls on Hold

If a C.O. line call is in progress and a doorbox is activated, a single or double “call waiting” tone will be heard indicating doorbox 1 or doorbox 2 is calling. To place the in-progress call on hold and answer the calling doorbox, simply dial a Touch Tone “#”, pulse dial a “2” or hook flash twice.

3. Activating a Doorstrike, Magnetic Lock or Gate Controller

To activate a relay contact, you must be communicating with a doorbox. Touch Tone dial “**”, pulse dial a “3” or hook flash three times. Two confirmation tones will be heard and the relay will be activated for the programmed doorstrike activation time. The phone will then be returned to the C.O. line. If a call was in progress, the original caller will be taken off hold to continue the conversation. To return to the original call without activating a relay, Touch Tone dial “#”, pulse dial a “2” or hook flash twice.

4. Features

| | <u>Touch Tone Commands</u> | <u>* Pulse Dial/Flash Commands</u> |
|--|----------------------------|------------------------------------|
| Momentarily activate doorstrike relay 1 or 2 | * * | Pulse dial 3 or hook flash 3 times |
| Continuously activate (latch) doorstrike relay 1 or 2 | * 1 | |
| Continuously de-activate (unlatch) doorstrike relay 1 or 2 | * 0 | |
| Activate opposite doorstrike relay | * 2 | |
| Toggle relay from last position | * # | |
| Answer or disconnect a doorbox call | # | Pulse dial 2 or hook flash 2 times |
| Monitor doorbox 1 | # 1 | |
| Monitor doorbox 2 | # 2 | |

Note: When on the C.O. line, if a Touch Tone other than # is entered, any additional Touch Tones in that dial string will be ignored. To regain control of the **C-1000B**, the phone must be momentarily placed on-hook.

* **Note:** Pulse dialing and flash commands are not compatible in the “Multiple Relay Activation” mode.

5. Keyless Entry/Postal Lock

When a momentary postal lock contact closure is made across terminals **6 & 7** (see **Installation** section **D**), the doorstrike 1 contact will activate for the programmed time.

6. Auxiliary Contact Mode (*7)

The auxiliary contacts are a separate set of contacts that can be programmed (see **Programming** section **B**) to activate in different patterns when doorbox 1 or doorbox 2 is activated. A momentary activation, a continuous activation while the doorbox is in use, and a ring cadence pattern are available. **Note:** The auxiliary contact mode (*7) is disabled when using the **CCTV Video Control Mode** (*8).

a. Timed Activation

If an auxiliary contact activation time is programmed (two digits **00-10** followed by **#03**), when either doorbox is activated, the auxiliary contacts will activate for the programmed time (.5 - 10 seconds). This is ideal for operating a doorbell or chime.

b. Continuous Activation

If the auxiliary contact is programmed to continuously activate (**11** followed by **#03**), while either doorbox is ringing or in use, the auxiliary contacts will latch. This is ideal for controlling lights, etc.

c. Ring Cadence Activation

If the auxiliary contact is programmed to custom ring cadence (“**12 #03**”) when doorbox 1 is activated, a repeating 1 second on and 3 seconds off contact pattern is generated. If doorbox 2 is activated, a repeating double burst contact pattern is generated with 3 seconds off between patterns. **Note:** Ring cadence activation is not compatible with the Analog PABX/KSU Station mode.

B. Doorbox Triggered CCTV Camera Switching / CCTV Video Control Mode (* 8)

The **C-1000B** allows two CCTV video cameras to be concentrated down to one video signal, by switching to the camera at the zone/entry point being used. When the **C-1000B** detects doorbox ringing or when a doorbox is monitored it will connect that camera’s video feed to the video output. This happens in a first come, first serve manner. When both doorboxes are inactive (idle) the **C-1000B** can be programmed to do one of four operations (See **Programming**, Section **B**, Page **6**):

1. Disconnect all cameras so there is no video output. This mode is very convenient when used in combination with a switching video RF modulator (Radio Shack part # 15-1214 or equivalent), which automatically switches the video source in when a video signal is present. A home TV’s broadcast/satellite program will be automatically interrupted to show video feed of the arriving guest (see **Installation** section **A**).
2. Connect video feed from camera 1.
3. Remain connected to the camera near the last doorbox activated and continue feeding video, until the other doorbox is activated.
4. Sequence video from both cameras, rotating every 4 seconds.

Note: The CCTV Video Control Mode (*8) is disabled when using the Auxiliary Contact Mode (*7).

Product Support Line...715.386.8666

Fax Back Line...715.386.4345

Due to the dynamic nature of the product design, the information contained in this document is subject to change without notice. Viking Electronics, and its affiliates and/or subsidiaries assume no responsibility for errors and omissions contained in this information. Revisions of this document or new editions of it may be issued to incorporate such changes.